

# **Model BMX-3**

## **SMD Disk Controller**

### **Technical Manual**

Document Number: 600-404-00

Revision: H

Date: 9/3/85

Serial No.:

## NOTICE

ZETACO, Inc. has prepared this Technical Manual for use by ZETACO personnel and its customers to assist in the installation, operation and maintenance of the model BMX-3 Disk Controller. The information contained herein is the property of ZETACO, Inc. and shall not be reproduced in whole nor in part without prior written approval of ZETACO, Inc.

ZETACO, Inc. makes every effort to produce quality products and documentation, however, the reader must be cautioned that changes may be made to the product not reflected in the supplied documentation. If you find errors or omissions, please notify ZETACO, Inc. to remedy the problem. ZETACO, Inc. shall not be responsible for any damages (including consequential) caused by reliance on this material as presented.

If installation problems arise after you thoroughly review the manual, please contact your ZETACO Authorized Factory Distributor, your Maintenance Contractor, or the ZETACO Customer Support Hotline at (612) 941-9480.

Copyright 1985. All rights reserved.

REVISION HISTORY

ECO No.	Date	Description	Pages
0529	11/85	Manual update-new paddleboards	
0531	12/18/85	FCC Cable Change to Current Std	2-1
0523	3/4/86	New Cover	
0576/0587	3/25/86	Update paddleboard configuration, incorporate slip-skip	viii,2-19, 2-25,3-6, 3-10,3-12, E-1,I-3
0618	5/19/86	Add Paddleboard Jumper Table	2-7, 2-9
0648	8/4/86	Add External Ground Wire to FCC cable.	2-15
0741	11/26/86	Add MV20000	1-5,2-6
0821	4/9/87	Add MV7800U & MV15000	see ECO coversht.



# Technical Manual for the BMX-3 Disk Controller

## PREFACE

This manual contains information regarding installation, testing, and operation of the ZETACO Model BMX-3 Disk Controller.

The technical contents have been written based on the assumptions that the reader 1) has a working knowledge of one of the applicable Data General mini-computers with associated RDOS, AOS, or AOS/VS operating system; 2) is familiar with standard installation, power, grounding, and peripheral cabling procedures; and 3) has access to technical information describing the disk drive(s) to be installed with this controller.

The information in this manual is organized into five major sections:

- SECTION 1.0      PRODUCT OVERVIEW - Describes the Model BMX-3 Disk Controller features, capabilities, specifications, power, and interface requirements.
  - SECTION 2.0      INSTALLATION PROCEDURES - Describes and illustrates the procedures required to install the BMX-3.
  - SECTION 3.0      TROUBLE-SHOOTING - Contains information useful in analyzing subsystem problems and how to get help.
  - SECTION 4.0      USAGE GUIDELINES - How various features and configurations are used and how they impact the performance of the controller.
  - SECTION 5.0      PROGRAMMING NOTES - Programming and operation.
- APPENDICES



## TABLE OF CONTENTS

	Page No.
Title Page	i
Notice	ii
Revision History	iii
Preface	iv
Table of Contents	v-viii
List of Tables, List of Illustrations	ix
Section:	
1.0 Product Overview	1-1
1.1 General Description	1-1
1.2 Features - Advantages	1-1
1.3 Specifications	1-3
1.3.1 Functional	1-3
1.3.2 Computer Interface	1-5
1.3.3 Disk Drive Interface	1-6
1.3.4 Mechanical	1-7
1.3.5 Power Requirements	1-7
1.3.6 Environmental	1-7
2.0 Installation	2-1
2.1 Unpacking and Inspection	2-1
2.2 Chassis Preparation	2-2
2.2.1 Priority Selection	2-2
2.2.2 Power Fail Protection	2-2
2.3 Controller Preparation	2-3
2.3.1 Computer Mode Selection	2-3
2.3.2 BMC Bus Termination	2-8
2.3.3 EEPROM Write Disable	2-8
2.3.4 Device Code Selection	2-8
2.3.5 Low Speed Disk	2-8
2.4 Disk Drive Preparation	2-10
2.4.1 Sectors Per Track Selection	2-10
2.4.2 Unit Number, Miscellaneous Preparation	2-12
2.4.3 Special Considerations	2-13
2.4.4 Remote Drive Start	2-13
2.5 Controller Board Installation	2-14
2.5.1 Paddleboard Installation	2-14
2.6 Cabling	2-14
2.6.1 Internal Disk Cabling	2-14
2.6.2 External Disk Cabling	2-15
2.6.3 BMC Bus Cabling	2-15
2.7 Subsystem Grounding	2-15
2.8 System Power Up	2-18
2.9 Using the Software Support Package Tape	2-18
2.9.1 Configuring The BMX-3	2-20
2.9.2 Disk Drive Sector Setting Verification	2-20
2.9.3 Disk Formatter	2-20
2.9.4 Disk Reliability	2-20
2.9.5 DFMTR/DKINIT	2-20
2.10 SYSGEN Considerations	2-21

2.11	BMX-3 Configurator	2-21
	2.11.1 Data Transfer Mode	2-22
	2.11.2 BMC Bus Priority	2-22
	2.11.3 Disk Configuration	2-22
	2.11.4 Error Correction Enable	2-23
	2.11.5 Throttle Burst Rate	2-23
	2.11.6 Break Count Interval	2-24
	2.11.7 Sector Slip	2-24
	2.11.8 Sector Interleave Ratio	2-24
	2.11.9 Media Format	2-25
	2.11.10 Sync Byte	2-25
2.12	Virtual Mapping	2-25
	2.12.1 Scope	2-26
	2.12.2 DG Disk Drive Sizing Characteristics	2-26
	2.12.3 DG Disk Emulation Groups	2-27
	2.12.4 Restrictions When Grouping DG Emulations	2-27
	2.12.5 Selecting Maximum Allowable Block Size	2-28
	2.12.6 System Unit to Physical Drive	2-28
	2.12.7 Media Efficiency	2-29
	2.12.8 Multiple Unit Assignment Per Drive Type	2-31
	2.12.9 Maximum Allowable Block Size Summarized	2-34
	2.12.10 Media Flaw	2-34
	2.12.11 Virtual Mapping Summarized	2-34
	2.12.12 Virtual Mapping Yield Per Drive Type	2-35
3.0	Trouble-shooting	3-1
3.1	Self Test	3-2
3.2	Software - Diagnostics and Utilities	3-3
	3.2.1 Using the Software Support Package Tape	3-3
	3.2.2 Disk Formatter	3-6
	3.2.2.1 Formatter Error Description	3-7
	3.2.2.2 Servo Clock Faults	3-7
	3.2.2.3 ECC Detected Errors	3-8
	3.2.2.4 ECC Undetected Errors	3-8
	3.2.2.5 Surface or Sector Address Errors	3-9
	3.2.2.6 Loss of Ready	3-9
	3.2.2.7 Default Parameters	3-9
	3.2.2.8 Additional Information for all Problems	3-10
	3.2.2.9 Slow Format	3-10
	3.2.3 Disk Diagnostic	3-10
	3.2.3.1 Diagnostic Error Description	3-11
	3.2.3.2 Servo Offset Forward	3-11
	3.2.3.3 Servo Offset Reverse	3-12
	3.2.4 Disk Reliability	3-12
	3.2.4.1 Reliability Error Description	3-13
	3.2.4.2 RELI - Loss of Ready	3-13
	3.2.4.3 RELI - Default Parameters	3-13
	3.2.4.4 RELI - Additional Information for all Problems	3-14
	3.2.5 CSDKINIT - RDOS Disk Initializer	3-14
	3.2.6 CSDKED - RDOS Disk Editor	3-16
	3.2.7 ECC Error Corrections Counter Function	3-19



3.3	System Errors	3-20
3.3.1	Testing a System Disk	3-20
3.4	Customer Support Hotline	3-21
3.5	Warranty Information	3-22
3.6	Product Return Authorization	3-22
4.0	Usage Guidelines	4-1
4.1	Controller Features	4-1
4.1.1	Configurator Aid (HELP)	4-1
4.1.2	Throttle Burst Rate	4-1
4.1.3	Sync Byte	4-1
4.1.4	Error Correction Enable/Disable	4-1
4.1.5	Interleave Factor	4-2
4.1.6	Disk Drive Types	4-2
4.2	Disk ECC Counter Utilities	4-3
5.0	Programming Notes	5-1
5.1	Instruction Format	5-1
5.2	Accumulator Formats	5-3
5.2.1	DOA - Specify Command and Drive	5-3
5.2.2	DOB - Load Starting Memory Address	5-4
5.2.3	DOC - Load Drive Address	5-5
	5.2.3.1 DOC - Specify Cylinder	5-5
	5.2.3.2 DOC - First DOC (extended Surf/Sect)	5-5
	5.2.3.3 DOC - Second DOC (Surf/Sect)	5-6
5.2.4	Read Status	5-6
	5.2.4.1 DIA - Read Data Transfer Status	5-6
	5.2.4.2 DIB - Read Drive Status	5-10
	5.2.4.3 DIC - Read Surf/Sect/Count	5-13
5.2.5	Read Status - Alternate Mode One	5-13
	5.2.5.1 DIA - Read Current Memory Address	5-13
	5.2.5.2 DIB - Read Extended Memory Address	5-14
	5.2.5.3 DIC - Not Implemented	5-14
5.2.6	Read Status - Alternate Mode Two	5-14
	5.2.6.1 DIA - Read ECC Remainder Upper	5-14
	5.2.6.2 DIB - Read ECC Remainder Lower	5-15
	5.2.6.3 DIC - Not Implemented	5-15
5.3	Detailed Command Descriptions	5-15
5.3.1	Data Transfer Commands	5-15
	5.3.1.1 Read Command	5-16
	5.3.1.2 Write Command	5-17
	5.3.1.3 Verify	5-17
	5.3.1.4 Format	5-17
	5.3.1.5 Read Buffers	5-18
5.3.2	Drive Commands	5-18
	5.3.2.1 Recalibrate	5-18
	5.3.2.2 Seek	5-18
	5.3.2.3 Offset Forward	5-18
	5.3.2.4 Offset Reverse	5-19
	5.3.2.5 Write Disable	5-19
	5.3.2.6 Release Drive	5-19
	5.3.2.7 Trespass	5-19
	5.3.2.8 Stop Disk	5-19
	5.3.2.9 Examine Ram	5-19

5.3.3	Alternate Modes	5-22
5.3.3.1	Alternate Mode One	5-22
5.3.3.2	Alternate Mode Two	5-22
5.4	Error Correction Code (ECC)	5-22
5.5	Format Sequencer	5-23

APPENDIX:

A.0	Diagnostic Bootstrap Procedures	A-1
A.1	Loading DSP from Tape to Disk	A-1
B.0	Memory Maps	B-1
B.1	BMX-3 Microprocessor Memory Map	B-1
B.2	EEPROM Map	B-2
C.0	Media Formats	C-1
D.0	The Command String Interpreter	D-1
D.1	Command String Functions	D-1
D.2	Command String Interpreter Examples	D-3
E.0	Format SWPAK Reg Bit Definitions	E-1
E.1	Diagnostic SWPAK Reg Definitions	E-2
E.2	Reliability SWPAK Reg Bit Definitions	E-3
I.0	Jumper Modifications	I-1
I.1	BMX-3 Mode 1A Configuration	I-1
1.1.1	BMX-3 Mode 1A Jumper Modifications	I-1
1.1.2	BMX-3 "A" Paddleboard Modifications	I-1
1.1.3	BMX-3 "B" Paddleboard Modifications	I-1
I.2	BMX-3 Mode 2A Configuration	I-2
1.2.1	BMX-3 Mode 2A Jumper Modifications	I-2
1.2.2	BMX-3 "A" Paddleboard Modifications	I-2
1.2.3	BMX-3 "B" Paddleboard Modifications	I-3

## LIST OF TABLES

		Page No.
Table 1.1	Computer I/O Slot Selection	1-5
Table 2.1	CPU MODE Selection	2-6
Table 2.2	Paddleboard Jumper Table	2-7
Table 2.3	Maximum Sector Table	2-10
Table 2.4	DG Emulation Groups	2-27
Table 2.5	Virtual Mapping Example Table	2-30
Table 2.6	DG Block Sizes By Multiple Units	2-32
Table 2.7	Drive Types	2-36
Table 3.1	Self-Test Errors	3-2
Table 5.1	Read/Write Faults (DIA)	5-9

## LIST OF ILLUSTRATIONS

		Page No.
Figure 2.1	Board Layout	2-4
Figure 2.2	"B" Paddleboard	2-5
Figure 2.3	Device Code Switch	2-9
Figure 2.4	Board Diagram	2-16
Figure 2.5	Daisy Chaining Drives	2-17
Figure 1.1	Mode Jumper Layout	1-4
Figure 1.2	Paddleboard Jumper Layout	1-5



## 1.0 PRODUCT OVERVIEW

### 1.1 GENERAL DESCRIPTION

The ZETACO BMX-3 Disk Controller provides a full emulation integration of up to four SMD-interfaced disk drives, with Data General (DG) Nova, Eclipse, and Eclipse MV Minicomputers, and RDOS, Eclipse RDOS, AOS, MP/AOS, AOS/VS operating systems. It is fully compatible with Data General hardware and software.

The BMX-3 is capable of operating on either the Burst Multiplexor Channel (BMC) or the Data Channel (DCH) and meets FCC hardened chassis requirements.

The BMX-3 provides for future expansion with the capability of supporting data transfer rates up to 2.5 megabytes per second and EEPROM technology, which allows most features to be software configurable through a "user friendly" configurator program.

The BMX-3 contains a unique feature called Virtual Mapping™ that allows many disk drives that would not normally map into the DG emulations to fit into the 606X, 616X and 6214 emulations through a scheme called Block Address Translation.

ZETACO provides up to a full 2 year warranty on the BMX-3 with Customer Support Hotline assistance and 48 hour turn around on board repair.

### 1.2 FEATURES - ADVANTAGES

- \*Emulation of DG 6060,6061,6067,6160,6161,6122 and 6214 disk subsystems
- \*Single controller is compatible with DG's full range of BMC equipped computers
- \*Simultaneous control of up to four SMD, HSMD and/or ESMD disk drives.
- \*Incorporates an eleven bit SMD tag bus to accommodate full capacity of the larger drives
- \*Simultaneously supports drives of different capacities, transfer rates, and media formats
- \*On-board 32 bit error detection and correction of burst errors up to 11 bits in length
- \*High speed microprocessor design and Ping-Pong buffering support maximum transfer rates

- .On-board Self-test with error reporting and LED display
- .User-definable sector interleaving
- .Adjustable DCH/BMC throttle control
- .Supports overlap seeks
- .Offset positioning for data error recovery
- .Automatic data strobe early/late for data error recovery
- .Two methods of power fail detection control open cable detect
- .Logging of the number of data corrections that have occurred on a per unit basis
- .One second pick/hold delay on power up controls disk drive power sequencing
- .Header address contains CRC for higher reliability
- .Auto retry on all header CRC errors
- .Dual volume drives supported (two physical volumes)
- .Supports dual ported drives
- .Disk drive sector setting verification insures proper disk drive setup.

## 1.3 SPECIFICATIONS

### 1.3.1 FUNCTIONAL

Drives per Controller: Up to 4 SMD, HSMD and/or ESMD drives

Recording Format: Zetaco standard media format

Disk Transfer Rate: Up to 2.5 Mbyte/sec.(20 MHz)

Sector Addressing: Contiguous or Interleave, programmable from 1:1 to 6:1

Sectors per Track: Supports up to 128 physical sectors per track - 64 sectors per logical unit

Maximum # of Heads: Supports up to 64 heads/disk

Maximum # of Cylinders: Supports up to 2048 cylinders through an 11 bit tag bus

Maximum Capacity: The theoretical non-emulation maximum capacity supported by a single BMX-3 is 17 Gigabytes.

Device Code: Switch selectable on Board edge (accessible after installation)

Interrupt Priority Mask Bit: 7 standard - fixed

Bus Load: 1 unit load (any I/O only slot)

Data Channel Interface: - 100ma drive at 0.8v  
- selectable from 4 to 256, 16 bit words per DCH access  
- 1 microsecond break between DCH throttle requests  
- maximum allowable DCH latency is 1 second (typical max for full performance is 422 microseconds)

## Burst Multiplexor Channel Interface:

- less than 1 STTL load.
- 300ma drive at 0.7v
- supports selectability of any of the 8 priority requests.
- selectable burst rates of 4 to 256, 16 bit words/access.
- selectable break between access of 1.4 microsecond to 14 milliseconds.
- maximum allowable BMC latency is 1 second. (typical max for full performance is 422 microseconds)
- supports BMC transfer rates up to 2.5 megabytes per second.

Sector Data field: 256 - 16 bit words per sector.

Data Buffering: Two 256 word Ping Pong buffers.  
One 256 word verify buffer.  
One 256 word BMC FIFO buffer.

Memory Address: 21 bits.

### Error Correction Polynomial:

Write -  $X^{32} + X^{23} + X^{21} + X^{11} + X^2 + 1$

Read -  $(X^{11} + X^2 + 1)(X^{21} + 1)$

Header CRC Polynomial:  $X^{16} + X^{15} + X^2 + 1$

### D.G. Subsystems Emulated:

Zebra - 6060 (96 MB)  
6061 (190 MB)  
6067 (50 MB)

Vulcan - 6122 (277 MB)

Kismet - 6160 (73 MB)  
6161 (147 MB)  
6214 (602 MB)

### Indicator Lights:

Red: Self-Test - Indicates disk controller is executing self-test diagnostics. If self-test fails, this LED will blink or remain on. (Self-test normally takes less than 1 second to complete.)

Yellow: Disk Select - When on, this LED indicates that none of the possible 4 units are selected.

Green: Controller Busy - This LED indicates the controller is executing one of the read/write commands.



### 1.3.2 COMPUTER INTERFACE

The BMX-3 can be configured for either Data Channel operation or Burst Multiplexor Channel operation and will function in virtually any Data General mini-computer in an I/O only slot.

-----  
CAUTION: THE BMX-3 MUST BE PLUGGED INTO AN "I/O ONLY"  
SLOT OR DAMAGE WILL RESULT.  
-----

TABLE 1.1 "I/O Only" Slot Selection

MODEL	I/O ONLY SLOTS
Nova 4C (5 slot)	3-5 (DCH only)
Nova 4S/X	12-16 (DCH only)
S120	12-16 (DCH only)
S140	12-16 (DCH or BMC)
S280	11-20 (DCH or BMC)
*M600	30-37 (DCH or BMC)
MV4000	12-20 (BMC only)
**MV6000	2-16 (BMC only)
MV7800U	Use original chassis type.
MV8000	29-42, 48-56 (BMC only)
MV8000-11	9-21 (BMC only)
MV8000C	13-20 (BMC only)
MV10000	13-24, 26-36 (BMC only)
MV15000	6-12 (BMC only)
MV20000	19-38

\*NOTE: Mode 1A required on BMX-3.

\*\*NOTE: Mode 2A required. BMX-3 requires the expansion chassis of the MV6000.

**BMC Bus Cables:** A pair of 40 conductor flat ribbon cables, with a single plug on one end and multiple plugs (for multiple controllers), are required for BMC operation. This cable daisy chains from the computer's BMC interface to the multiple BMC peripheral controllers. The controller at the end of the chain must have it's BMC terminators installed; the others must have them removed. Reference Installation Section 2.6.3, see Figure 2.4.

### 1.3.3 DISK DRIVE INTERFACE

- Functional:
- Standard SMD interface.
  - Supports extended cylinder addressing on pins 30 and 60 of the "A" cable (2048 cylinders).
  - Supports Remote Pick-Hold drive sequencing (pins 29 and 59).
  - Requires Index and Sector signals in the "A" cable.
  - Supports unit select 0,1,2 and 3.
  - Supports Dual Channel as defined by the CDC SMD specification.

- Electrical:
- MC3450/MC3453 Quad line drivers and receivers.

Cabling: NON-FCC

"A" Cable:

One 60-Conductor Shielded Round Cable for the first disk drive (daisy-chain).

"B" Cable:

One 26-Conductor Shielded Round Cable for the first disk drive (radial).

FCC

"A" Cable:

INTERNAL: One 60 conductor flat ribbon cable with D connector on one end that mounts in the computer EMI/RFI back-panel. The other end plugs into the B paddleboard. See Figure 2.4.

EXTERNAL: One 60 conductor shielded round cable for the first disk drive (daisy chain).

"B" Cable:

INTERNAL: One 26 conductor flat ribbon cable with D connector on one end that mounts in the computer EMI/RFI back-panel. The other end plugs into the A paddleboard. See Figure 2.4.

EXTERNAL: One 26 conductor shielded round cable for the first disk drive (radial connection).

NOTE: The maximum cumulative length allowable for the "A" cable is 100 feet, and for the "B" cable is 50 feet, as per drive manufacturers recommendations.

**Multiple Drives:** Up to four drives (dual volume counts as two) per controller. The "A" cable daisy chains from drive to drive, with the last drive in the chain requiring an "A" cable terminator. The "B" cable connects radially to each drive (no terminators required). Reference Figure 2.5.

#### 1.3.4 MECHANICAL

**Dimensions:** 15" x 15" x 1/2"

**Shipping Weight:** 10 pounds - includes controller, paddleboards, cables (if ordered), diagnostics and documentation.

**Paddleboards:** "A" paddleboard:  
Passive backplane paddleboard with four 26-pin cable connectors. ("A" backplane)  
"B" paddleboard:  
Passive backplane paddleboard with one 60-pin cable connector. ("B" backplane)

#### 1.3.5 POWER REQUIREMENTS

+5 (+ 5%) Volts DC @ 8.5 Amps typical  
-5 (+ 5%) Volts DC @ 0.45 Amps typical

#### 1.3.6 ENVIRONMENTAL

##### OPERATING ENVIRONMENT:

**Temperature:** 0 to 55 degrees C  
**Relative Humidity:** 10% to 90% (non-condensing)

##### NON-OPERATING ENVIRONMENT:

**Temperature:** -45 to +115 degrees C  
**Relative Humidity:** 10% to 90% (non-condensing)

Exceeds all Nova/Eclipse/MV temperature and humidity specifications.



## 2.0      INSTALLATION

This section contains the procedures necessary for proper installation of the BMX-3 Disk Controller. Please read carefully.

Sections 2.1 - 2.8 involve preparation and installation of the hardware components. Installation personnel should have access to hardware documentation of the computer and disk drive. Sections 2.9 - 2.11 describe the Programming Considerations.

## 2.1      UNPACKING AND INSPECTION

The following items are shipped with each BMX-3 Disk Controller:

- a) Controller (500-404-00)
- b) Board Cover
- c) Backplane Paddleboards    A - 500-408-00  
  B - 500-409-00
- d) Internal FCC Cables (Optional)    A - 300-104-0X  
  B - 300-014-0X
- e) External Cables (Optional)    FCC A       - 300-013-0X  
  NON-FCC A - 300-147-0X  
  FCC B       - 300-011-0X  
  NON-FCC B - 300-145-0X
- f) BMC Bus Cables (300-038-00)
- g) Software Support Package (9-track mag tape)  
   (400-404-00)
- h) Optional Sector Slip Package (9-track mag tape)  
   (400-404-01)
- i) Technical Manual (600-404-00)

It is recommended that all packing materials and cartons be saved, in case re-shipping is necessary.

Upon receipt of the Model BMX-3 from the carrier, inspect the shipping carton immediately for any evidence of damage or mishandling in transit.

If the shipping carton is water stained or damaged, contact the carrier and shipper immediately, specify the nature and extent of the damage and request that the carrier's agent be present when the carton is opened.

ZETACO'S warranty does not cover shipping damage.

For repair or replacement of any ZETACO product damaged in shipment, call ZETACO or a ZETACO Authorized Distributor to obtain return authorization instructions.

## 2.2 CHASSIS PREPARATION

Before installing the BMX-3, the disk drive, controller, and computer chassis must be prepared. First, select an appropriate "I/O ONLY" slot in the computer chassis that will provide an acceptable interrupt priority. See Table 1.1.

### 2.2.1 PRIORITY SELECTION

The controller must receive two priority signals from the DG minicomputer backplane, DCH priority in (Pin A94) and interrupt priority in (Pin A96). If there are vacant slots between the controller and the processor, priority jumper wires must be installed to obtain priority continuity between controllers. To jumper across unused slots, connect DCH priority out (Pin A93) to DCH priority in (Pin A94) and interrupt priority out (Pin A95) to interrupt priority in (Pin A96).

If the BMX-3 is to be configured at or near highest priority in an S140 computer, (Slots 12-16 I/O Only) jumper the priority first up to the BMX-3, then back down to the additional controller boards in Slots 4 and up.

### 2.2.2 POWER FAIL PROTECTION

The BMX-3 disk controller contains a double protection power fail scheme. The DG CPU outputs a signal on pin B21 called "Power Fail" which gives an early warning of power loss. This is used on the BMX-3 to disable the drives write circuitry through the open cable detect line.

Slots 12-15 in the S140 do not have power fail, therefore, a jumper wire should be installed to enable this feature. Slot 16 has it available on B21. Refer to your CPU manufacturer's manual if additional information is needed.

In addition, the BMX-3 contains its own power fail circuitry to further protect drive data integrity in the event the slot where the board is installed loses power.

## 2.3 CONTROLLER PREPARATION

Figure 2.1 shows the BMX-3 board layout with the pertinent configurable items called out. Use this figure to locate the necessary switches and jumper plugs for the following sections. The board cover may have to be removed for some of these configurable items. Refer to Table 2.2 for Paddleboard Jumper Table.

### 2.3.1 COMPUTER MODE SELECTION

The BMX-3 has been set to Mode 1 at the factory unless specified otherwise. The BMX-3 must be configured in two ways: 1) Configuring to the correct CPU via 24 pin mode plug on the circuit board and the B paddleboard, and 2) Choosing a feature select with a jumper plug on the circuit board and the B paddleboard.

First configure the mode plug to your CPU type. Four modes are possible. Table 2.1 indicates the CPU mode selections.

- MODE 1 - This is the standard configuration and provides these features: dual port, extended 11 bit tag bus (for use with disk drives in excess of 1024 cylinders) and remote Pick/Hold power sequencing.
- MODE 2 - Required on certain CPU types but sacrifices two of the three available features. Choose one of the three following features: dual port, extended 11 bit tag bus (for use with disk drives in excess of 1024 cylinders) or remote Pick/Hold power sequencing.
- MODE 1A - Provides the same features as mode 1 for the following computers: S250, C350, M600. See Appendix I.
- MODE 2A - Provides the same features as mode 2 for the MV6000 Expansion Chassis. See Appendix I.

When changing from Mode 1 to Mode 2 simply remove the 24 pin mode plug (on the BMX-3 and B paddleboard), turn it 180 degrees and re-insert. Second, choose the feature plug (on the BMX-3 board and paddleboard) for the desired feature. To determine which CPU mode to choose, reference Table 2.1.

NOTE: For some CPU's the BMX-3 can be configured in either Mode 1 or Mode 2, (identified on Table 2.1 as ALT). Mode 1 is preferred since it retains all 3 features. Mode Selection is shown on Board Cover.





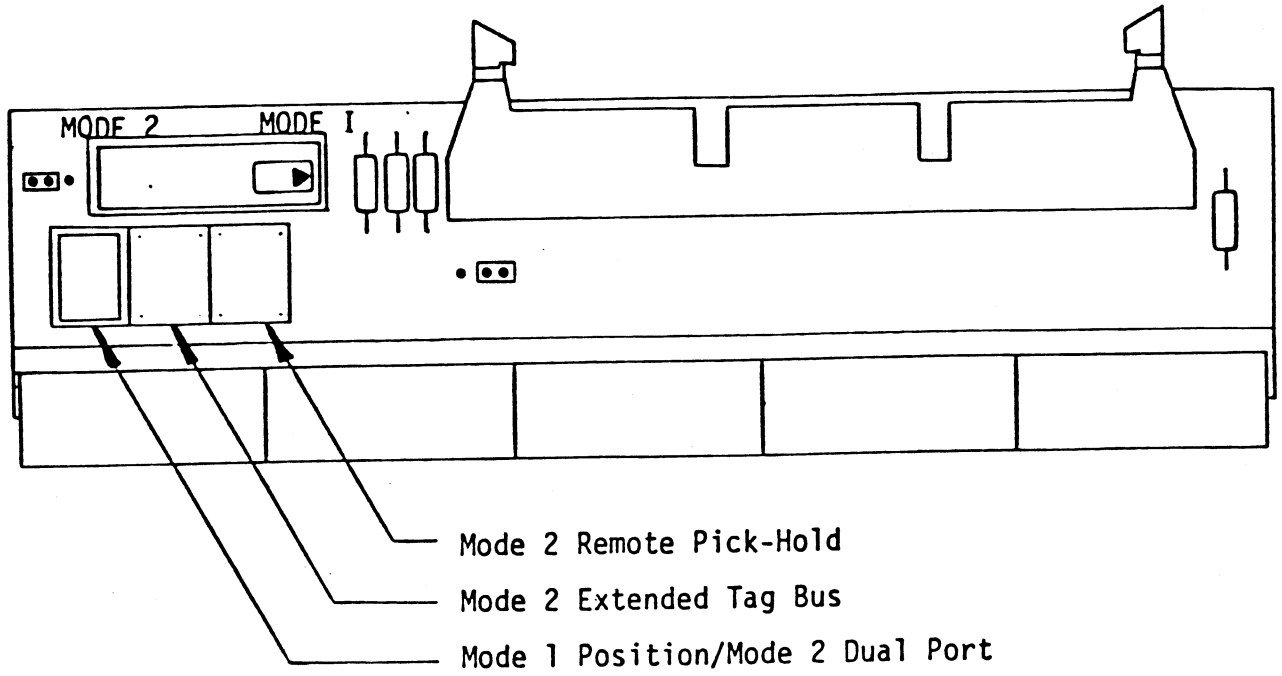

FIGURE 2.2 "B" Paddleboard



The feature selections are referenced in Figures 2.1 and 2.2. When you have chosen CPU Mode 1 you must have the feature select plug installed in the "Mode 1 Default/Dual Port" position. Unless this feature select plug is inserted properly, the Controller will not function correctly.

NOTE: When you have chosen Mode 2 you have a choice of 1 of the 3 features. You cannot choose more than one. Example: for dual port, insert the feature plug marked "Mode 1 Default/Dual Port" on the BMX-3 board and the B paddleboard.

TABLE 2.1 CPU Mode Selection

MODEL	MODE 1	MODE 2	MODE 1A	MODE 2A
NOVA 4C	X			
NOVA 4S	X			
NOVA 4X	X			
S120	X			
S140	X			
S280	X	ALT.		
M600			X	
MV4000	X	ALT.		
MV6000 				X
MV7800U 		X		
MV8000		X		
MV8000-II		X		
MV8000C		X		
MV10000 	X	ALT.		
MV15000		X		
MV20000		X		

NOTES:

 MV10000 REV 02 backplane and less requires Mode 2 operation.

 Mode 2A is to be used only in the MV6000 I/O expansion chassis.

 Set the BMX-3 up for the Mode of the chassis that is being used.

NOTE: Modes 1A and 2A require the Modes 1 and 2 plug selections, respectively, in conjunction with jumper changes on the controller and paddleboards. See Appendix I.

TABLE 2.2 Mode Jumper Table

# 500-408-00  
REVISION C  
OR HIGHER

# 500-409-00  
REVISION B  
OR HIGHER

BMX-3	A Paddleboard	B Paddleboard	MODE 1	MODE 2	MODE 1 A	MODE 2 A
W 34-1						X
W 34-2			X	X	X	
W 34-3			X	X	X	
W 34-4						X
W 34-5			X	X	X	
W 34-6						X
Pins 1,2,3 near B83 - lower right hand corner			1-2	1-2	2-3	1-2
Jumper at N1			Mode 1/2	Mode 1/2	Mode 1A	Mode 1/2
24-pin jumper at DD5			Mode 1	Mode 2	Mode 1	Mode 2
	Outside Jumper at 2A		Away From 2A	Away From 2A	Away From 2A	Toward 2A
	Outside Jumper at 1A		Away From 1A	Away From 1A	Toward 1A	Away From 1A
		W1				X
		W2	X	X	X	
		W3			X	
		W4	X	X		X
		24-Pin Jumper Plug	Mode 1	Mode 2	Mode 1	Mode 2

X = jumper is in or mode plug arrow is pointing toward this mode.

### 2.3.2 BMC BUS TERMINATION

If there is more than one BMC device daisy chained on the BMC bus, then the BMC controller at the end of the bus must have the bus terminators installed. If the BMX-3 is to be installed as the last or only BMC controller, then make sure the 3 bus terminators are installed at locations A12, B12, and C12 on the controller board. Reference Figure 2.1.

NOTE: The BMX-3 is shipped from the factory with these terminators installed unless otherwise specified.

### 2.3.3 EEPROM WRITE DISABLE

The BMX-3 provides the means to hardware disable any further alterations to the configuration EEPROM. To write disable the EEPROM, cut foil jumper W22-1 located at D5 on the controller board. Foil jumper W22-1 is factory installed. Do not cut this jumper before configuration has been completed. Refer to Section 2.11.

### 2.3.4 DEVICE CODE SELECTION

The BMX-3 provides a set of Device Code switches on the board edge that allows the user to easily change the device code without having to remove the controller from the computer chassis. See Figure 2.3. The standard Primary device code is 27 octal and Secondary is 67 octal, however, any standard DG device code can be selected. Switches 1 and 2 are not used. Switches 3 through 8 specify device code. Reference Figures 2.1 and 2.3 for proper switch selection.

### 2.3.5 LOW SPEED DISK

In Burst Multiplexor Channel mode, the BMX-3 will function with Disk Drives ranging in speed from less than 5 MHZ serial bit rate up to 20 MHZ. In Data Channel mode the standard configuration supports transfer rates between 8 MHZ and 20 MHZ. If a disk drive slower than 8 MHZ is to be connected and run in DCH mode, then cut foil jumper W15-2 and add a 47 ohm resistor jumper to W15-1. Foil jumper W15-2 is factory installed.

JUMPER POSITION INSTALLED	BMC MODE	DCH MODE
High Speed (W15-2)	<5 mhz-20 mhz	8 mhz-20 mhz
Low Speed (W15-1)	<5 mhz-15 mhz	<5 mhz-15 mhz

FIGURE 2.3 Device Code Switch

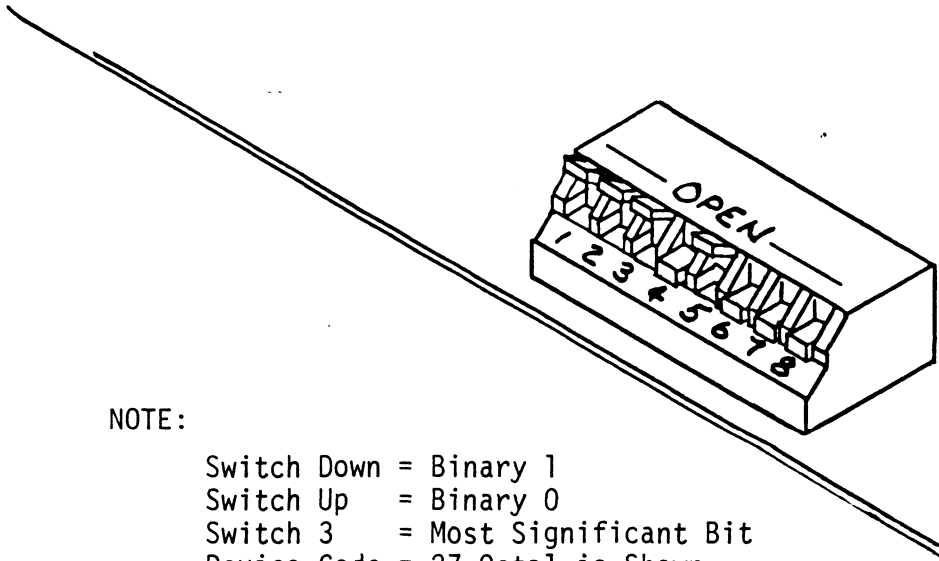

NOTE:

Switch Down = Binary 1  
 Switch Up = Binary 0  
 Switch 3 = Most Significant Bit  
 Device Code = 27 Octal is Shown

DEVICE CODE	S1 RESERVED	S2 RESERVED	S3 DS0	S4 DS1	S5 DS2	S6 DS3	S7 DS4	S8 DS5
0X			UP	UP	UP			
1X			UP	UP	DOWN			
2X			UP	DOWN	UP			
3X			UP	DOWN	DOWN			
4X			DOWN	UP	UP			
5X			DOWN	UP	DOWN			
6X			DOWN	DOWN	UP			
7X			DOWN	DOWN	DOWN			
X0						UP	UP	UP
X1						UP	UP	DOWN
X2						UP	DOWN	UP
X3						UP	DOWN	DOWN
X4						DOWN	UP	UP
X5						DOWN	UP	DOWN
X6						DOWN	DOWN	UP
X7						DOWN	DOWN	DOWN

## 2.4 DISK DRIVE PREPARATION

Refer to the disk drive manufacturer's installation manual to unpack, unlock the head assembly, and for general installation instructions.

### 2.4.1 SECTORS PER TRACK SELECTION

The number of sectors per track to which each disk drive should be set is shown in Table 2.3 below. Find the disk drive model that will be run on the BMX-3. Adjacent to the model is the number of sectors to which the disk should be set.

NOTE: If the BMX-3 is configured for split sectors for any disk drive, that particular disk drive will appear to the system as two disks with half the number of sectors shown in the maximum sectors column of the table below. The table shows the maximum number of sectors for each disk model using at least 576 bytes in each sector of the disk surface. Problems are inevitable if this number is not adhered to. Use this number to calculate the number of sectors a disk drive can have if it is not shown in Table 2.3.

TABLE 2.3 Maximum Sectors Table

DISK DRIVE MODEL	MAXIMUM NUMBER OF SECTORS SUPPORTED
A1-AMPEX 165	35
A2-AMPEX 330	35
A3-AMPEX 980	35
A4-AMPEX 80	35
A5-AMPEX 660	35
A7-AMPEX 932	35
A8-AMPEX 964	35
A9-AMPEX 996	35
AA-APS 4830-202	70
AB-APS 4835-202	70
AC-APS 4830-337	70
AD-APS 4835-337	70
AE-APS 4830-404	70
AF-APS 4835-404	70
AG-APS 4865	70
AL-AMCODYNE 7110	32
AM-AMCODYNE 8160	35
C1-CDC 9730-80	35
C2-CDC 9730-160	35

C3-CDC 9762	35
C4-CDC 9766	35
C5-CDC 9775	35
C6-CDC 9710 (RSD)	35
C7-CDC 9715-160	35
C8-CDC 9715-340	35
C9-CDC 9715-515	51
CA-CDC LARK 9457	32
CB-CDC LARK 9455	32
CC-CDC CMD 9448-32	35
CD-CDC CMD 9448-64	35
CE-CDC CMD 9448-96	35
CF-CDC 9410-8	23
CG-CDC 9410-24	23
CH-CDC 9410-32	23
CI-CDC 9410-40	23
CJ-CDC 9412	35
D1-DATA PER.D1600	35
DA-DISC TECH 3306	35
E1-CENTURY 300	35
E2-CENTURY 302	35
E3-CENTURY 306	35
E4-CENTURY AMS 315	35
E5-CENTURY T82	35
E6-CENTURY 160	41
E7-CENTURY AMS 513	55
E8-CENTURY AMS 380	55
E9-CENTURY AMS 571	56
EA-CENTURY C2048	32
F1-FUJITSU 2280	35
F2-FUJITSU 2284	35
F3-FUJITSU 2294	35
F4-FUJITSU 2351*	48 (586 bytes/sector)
F5-FUJITSU 2311	35
F6-FUJITSU 2312	35
F7-FUJITSU 2322*	35 (582 bytes/sector)
F8-FUJITSU 2333*	70 (584 bytes/sector)
F9-FUJITSU 2331*	70 (584 bytes/sector)
F10-FUJITSU 2361*	70 (585 bytes/sector)
FA-FUJITSU 2298*	70 (585 bytes/sector)
K1-KENNEDY 7380	35
K2-KENNEDY 5380*	35 (572 bytes/sector)
K3-KENNEDY 53160*	35 (572 bytes/sector)
K4-KENNEDY 7340	35
M1-MEGAVault 83	35
M2-MEGAVault 116	35
MA-MEMOREX 677-30	35

MB-MEMOREX 677-70	23
MC-MEMOREX 213	35
MD-MEMOREX 214	35
N1-NEC 2220	35
N2-NEC 2230	35
N3-NEC 2246	35
N4-NEC D2351	62
P1-PRIAM 15450	35
P2-PRIAM 804	35
P3-PRIAM 3350	35
P4-PRIAM 3450	23
P5-PRIAM 7050	23
P6-PRIAM 6650	35
T1-TECSTOR 85	35
T2-TECSTOR 165	35
T3-TECSTOR 200	35
T4-TECSTOR 300	35
T5-TECSTOR 160	35
UD-USER DEFINED	128 (drive dependent)

If the disk drive you are installing is not on the list, refer to the Configurator Command menu. Choose selection D (Disk Drive/s). Answer the associated questions on your operating system. When a list of disk drive manufacturers displays, push "H", then carriage return to review the heads, cylinders, sectors, unformatted capacity and format type. Choose a drive similar in characteristics or choose "UD", (User Defined). UD is listed under RDOS in the command menu. UD is available under AOS/AOS VS when you choose a non-standard drive.

Refer to your disk drive manual and carefully determine the the correct switch positions for the sector count and set the the switches in the disk drive accordingly.

- \* Use appropriate sector selection by referring to manufacturers manual on calculating sectors and calculate based on the desired number of bytes/sector.

#### 2.4.2 UNIT NUMBER AND MISCELLANEOUS PREPARATION

Set the drive(s) to the desired unit numbers. This is usually done via a switch in the drive or by changing lens caps on the front. For two or more drives, unit numbers assigned are usually consecutive, with unit "0" being the primary unit. For dual-volume drives such as CDC's CMD, Lark, etc., or drives that the controller treats as dual volume (indicated in the Disk Drive "HELP" section of ZETACO's Configurator program on the Software Support Package tape), the drive must be set to unit 0 or 2, with the next consecutive odd unit number used by the other volume of the disk drive. Ensure the disk drive you are installing has the index and sector signals on the "A" cable. If these signals are on the "B" cable only, the controller will not function correctly.



### 2.4.3 SPECIAL CONSIDERATIONS

#### SPECIAL CONSIDERATIONS FOR THE FUJITSU 2351 SECTOR SELECTION

The FUJITSU 2351 should be set to 48 sectors per track by setting the number of bytes per sector to 586 and not 587 as indicated the Fujitsu 2351 manual. This will provide a more even distribution of the available track capacity between the 48 sectors, allowing the subsystem to perform better.

The following Fujitsu jumpers should be installed to achieve 586 bytes per sector:

BC7	2-3	6-7	10-11	12-13
BD7	3-4	6-7	9-10	13-14
BE7	3-4	5-6	10-11	13-14
BF7	3-4	6-7	10-11	13-14

NOTE: On Formatter and Reel you will see the following information displayed (AOS, AOS/VS):

UNIT	TYPE	HDS	CYLS	SEC/TRK	SECTOR PULSES
0	0	19	815	24	48 sufficient bytes/sector ?
1	1	19	815	24	48 sufficient bytes/sector ?

In this example, the Sector Pulses are correct, allowing you to proceed.

#### SPECIAL CONSIDERATIONS FOR THE CDC 9457 (LARK II) AND CDC 9455 (LARK)

Ensure options W-4 and W-8 are installed within the disk drive. W-4 identifies Auto Seek on head change. W-8 identifies two volumes (CDC terms it CMD). The CDC Lark is factory set at 32 sectors. The 64 sector version is not useable.

### 2.4.4 REMOTE DRIVE START

On initial power up, the Controller will delay activating Pick/Hold (spins up drive) for one second. This feature eases the initial current demand on the AC power source. This feature requires that the disk drive be selected for remote operation. If the remote spin up feature has not been selected in Mode 2, then Pick/Hold is grounded, which will issue a continuous Pick/Hold.

## 2.5 CONTROLLER BOARD INSTALLATION

Carefully select an I/O ONLY slot, (reference Table 1.1), and guide the controller board in by allowing the edges of the board to follow the guides evenly. Use the lock tabs on the two outside corners to provide leverage when the board meets the connector. Use equal pressure on both lock tabs until the board seats firmly into the backplane connectors.

CAUTION: AN I/O ONLY SLOT MUST BE USED. COMPONENT DAMAGE WILL OCCUR IF A SLOT OTHER THAN I/O ONLY IS USED. REFER TO SECTION 1.3.2. ZETACO'S WARRANTY IS VOID IF A NON-I/O ONLY SLOT IS USED.

### 2.5.1 PADDLEBOARD INSTALLATION

Two paddleboards connect onto the minicomputer backplane pins. Observe which slot the BMX-3 occupies in order to determine which set of backplane pins to use for connection. One paddleboard connects to the "A" backplane and one on the "B" backplane. Make sure the CPU backplane pins are straight first, then reference Figure 2.4 for proper installation. The paddleboard (labeled "B") with the 60-pin header goes on the "B" backplane. The paddleboard (labeled "A") with the four 26-pin headers goes to the "A" backplane.

A fair amount of insertion force resistance is presented by these connectors, so carefully rock the paddleboard back and forth while exerting pressure in order to guide all the pins into the connector.

## 2.6 CABLING

### 2.6.1 INTERNAL DISK CABLING

As shown in Figure 2.4, the socket connector end of the 60-conductor cable (referred to as Internal SMD "A" cable) plugs into the "B" paddleboard. The other end of this cable (D connector) mounts on the backpanel.

NOTE: Paddleboard "B" with 12-pin mode plug may extend too high when trying to plug in the paddleboard with another controller board and the paddleboard is set in the next slot. Simply pop off the red cap of the 12-pin mode plug exposing the internal metal jumpers.

The socket connector end of the 26-conductor cable (referred to as internal SMD "B" cable) plugs into the "A" paddleboard. The other end of this cable (D connector) mounts on the backpanel. Observe the port assignments on the paddleboard in order to keep track of which ports are 0-3 on the backpanel. If more than one drive is to be connected, we recommend labeling the associated port(s) on the CPU connector panel.

### 2.6.2 EXTERNAL DISK CABLING

As shown in Figure 2.5, the 60-conductor "A" cable connects the appropriate backpanel D connector to the first drive, then continues from drive to drive in a daisy chain fashion. The last drive in the chain must have a terminator installed in place of the daisy chain cable. This terminator is located within the disk drive.

Each drive must have a 26-conductor "B" cable connected between the drive and the backpanel D connector in a radial fashion. Connect external ground wire on both A and B cables to the drive's chassis ground.

Ensure that the port is configured (by use of Configurator Program) to match the corresponding drive type plugged into that port.

If Non-FCC cables are being used, the "A" cable plugs directly into the "B" paddleboard, and the "B" cable plugs directly into the "A" paddleboard.

### 2.6.3 BMC BUS CABLING

The two BMC bus cables provided have a single 40-pin connector on one end and a group of 4, 6, or 8 connectors on the other end. Install the BMC bus cables as shown in Figure 2.4, observing proper connector orientation, by plugging the single-plug end of the cables into the DG BMC I/F and the multiple-plug end of the cables into the BMX-3 and other BMC peripheral controllers. Reference Section 2.3.2 for BMC termination installation. If the data channel is being used for data transfer, the BMC cables need not be installed.

### 2.7 SUBSYSTEM GROUNDING

Because the AC power system safety ground does not necessarily satisfy all system grounding requirements, additional connections are required to earth ground, referred to as system ground. The controller and its attached drive(s) must be connected to a singlepoint ground system. Ground connections are made via ground braids that pass from drive to drive, drive to computer chassis and computer chassis to earth ground. Refer to Figure 2.5.

FIGURE 2.4 Board Diagram

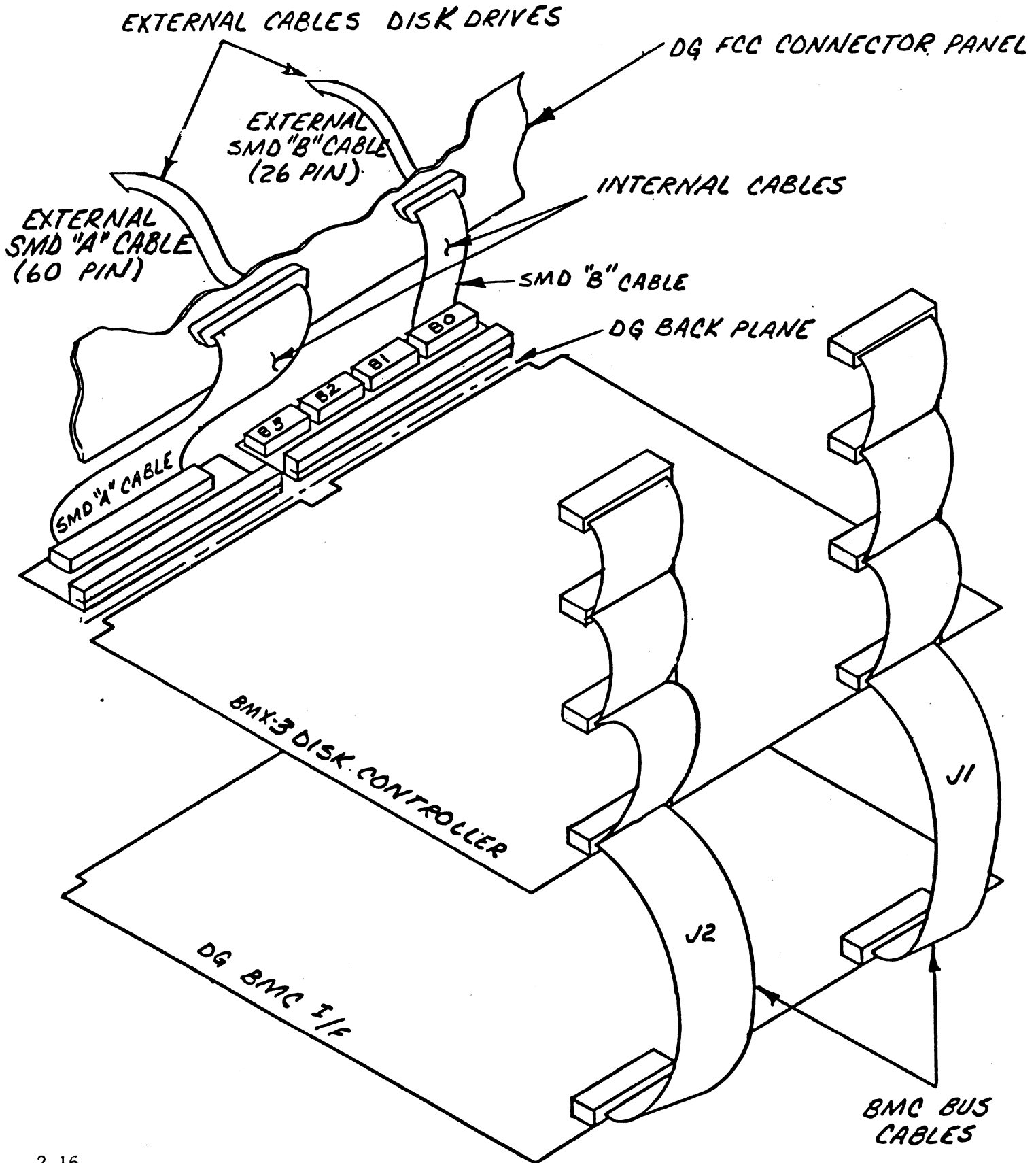
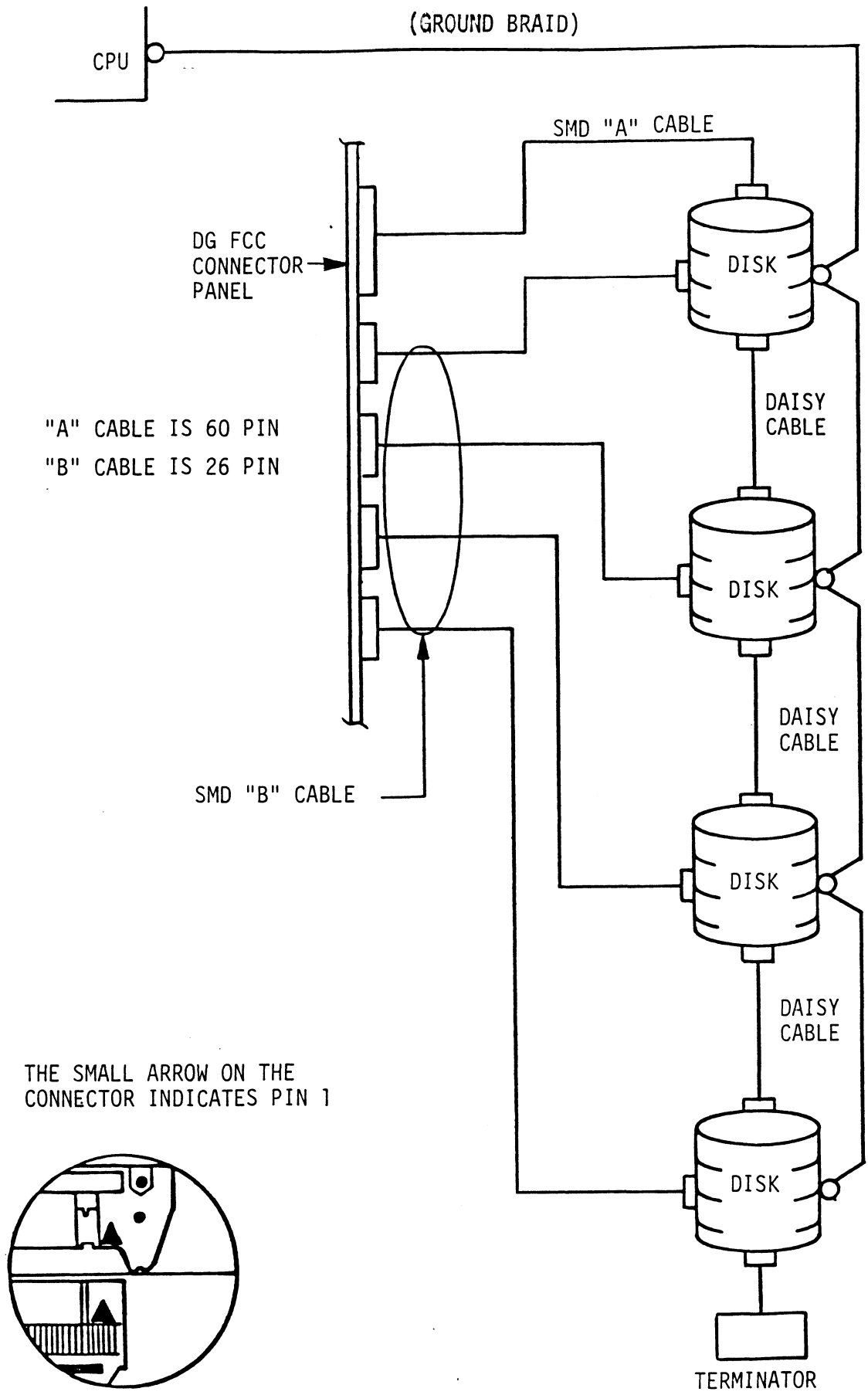

FIGURE 2.5 Daisy Chaining Drives



**WARNING** - To ensure proper ground return to earth, each component in the system must be connected using a daisy chain ground system. The AC and DC grounds within each drive may need to be joined (consult your drive manual). The drives must then be joined by a daisy chain grounding braid and connected to the grounding post at the rear of the computer cabinet.

## 2.8 SYSTEM POWER UP

Turn system power ON. The BMX-3 will perform an initial "Self-test" by briefly lighting a red LED. A good test is indicated by the LED turning OFF. For more details or if selftest fails refer to Section 3.0. After power up, the yellow LED should turn off if the controller has not been configured for a dual port drive and the disk drive is powered on. See Section 1.3.1 for LED definitions.

## 2.9 USING THE SOFTWARE SUPPORT PACKAGE TAPE

The Software Support Package tape is structured so that the programs on Files 2 through 7 can be loaded and executed directly from the tape. Files 0 and 1 contain the software that enables you to boot from the tape and select the particular program you want loaded into the system.

Each of the programs on Files 2 through 7 is a stand-alone program. This means that they do not need, and cannot have, an operating system running when they are executed. Programs cannot be loaded onto your disk directly from Files 0-7. File 8 for RDOS and File 9 for AOS (or AOS/VS) contain the programs in the standard system dump format and you can load them from these files to your disk. Even after the programs have been transferred to your disk, you should retain the Software Support Package tape in case of disk subsystem problems.

The following sequence of events is recommended by ZETACO. Each step is described in greater detail in the subsequent sections of this chapter.

1. Mount the Software Support Package tape and boot it.
2. Select #2 on tape menu - configure the Controller.
3. Select #4 - format the media. (Generally required.)
4. Select #3 - disk Diagnostics.
5. Select #5 - disk Reliability.

NOTE: It is not essential that you run Diagnostics or Reliability; however, they will locate disk subsystem problems. It is better that this be checked out at this point than after you have loaded your data.

The Bootstrap Procedure for the Software Support Package tape is:

1. Mount the Software Support Package tape on the drive and put it on-line. Be sure that the BPI setting matches that specified on the tape label.
2. Program Load. The method of program load varies for the different processors. Some of the possibilities are described here.

If your system has front-panel switches, set them to 100022 when loading from the primary tape drive, or to 100062 when loading from the secondary tape drive. Then press reset and the program load switch.

For the S140 virtual console, set 11A to 100022 (or 100062 for secondary tape drive). Then enter 100022L (or 100062L).

For the S120 virtual console, enter 22H (or 62H for the secondary tape drive).

For MV class CPU's you must enter the full virtual console and respond to the prompt:

```
SCP-CLI>  
with BOOT 22 (or 62 for secondary tape)
```

3. The Software Support Package Menu will be displayed:

FILE #	PROGRAM
2	.BMX-3 CONFIGURATOR
3	DISK DIAGNOSTICS
4	DISK FORMATTER
5	DISK RELIABILITY
6	CSDKINIT-RDOS DISK INITIALIZER
7	CSDSKED-RDOS DISK EDITOR
8	".SV & .LS" Files and any Utilities in RDOS DUMP Format
9	".SV & .LS" Files and any Utilities in AOS DUMP Format
10	AOS/VS Utilities in AOS DUMP Format

File Number?

You should enter the number of the program you wish to execute.

### 2.9.1 CONFIGURING THE BMX-3

The Configurator Program replaces hardware switches. You must run File #2 on the Software Support Package in order to install your BMX-3. See Section 2.11 for further information.

### 2.9.2 DISK DRIVE SECTOR SETTING VERIFICATION

The BMX-3 provides a feature that allows the Formatter, Reliability and Diagnostics Programs to display the actual number of sector pulses detected by the controller. This enables the user to verify that the disk drive has been correctly configured before attempting any data transfers.

NOTE: ONLY FULL SECTORS WILL BE COUNTED.

### 2.9.3 DISK FORMATTER

NOTE: If the Sector Slip option is utilized, skip this section and refer to the Sector Slip Manual.

The first thing to be done after the BMX-3 is configured is to run the Formatter Program (File #4). Run a minimum of 3 passes, preferably 6 passes, of surface analysis. Be sure to disable Error Correction with the Configurator Program before starting the Formatter Program. See Section 3.2 for more detailed information.

### 2.9.4 DISK RELIABILITY

It is recommended that the Disk Reliability program (File #5 on tape) be run for at least one pass to ensure a reliable subsystem before storing the system data on it. If any problems are encountered, the disk Diagnostic, (File #3 on tape) can be used to identify the source of the problem. See Section 3.2 for more detailed information.

### 2.9.5 DFMTR/DKINIT

The disk is now ready to be initialized by running D.G.'s DFMTR program (not supplied with controller) for AOS or AOS/VS operating systems. Run ZETACO'S CSDKINIT program on File #6 of the Software Support Package tape for RDOS or ERDOS. D.G.'s DKINIT will also work for true emulations, but CSDKINIT gives the capability of expanded capacity support. ZETACO recommends CSDKINIT for RDOS/ERDOS.

NOTE: When initialization is complete, the on-board ECC can be enabled with the Configurator Program.

See Section 3.2 for more details.



## 2.10 SYSGEN CONSIDERATIONS

Listed below is an example of part of the RDOS system generator.

1. Number of 6060/6061/6067/6122/6160/6161 Disk Controllers (0-2)
2. Device Primary ("0") or Secondary ("1")
3. Controller #1 6160/6161 Type? ("0"=NO, "1"=YES)
4. Number of Devices for Controller #1 (1-4)
5. Number of other types of Moving Head Disk Controllers (0-2)
6. Device Primary ("0") or Secondary ("1")

NOTE: On line three answer NO when running RDOS. When you answer NO, you allow up to four disk drives (6160 or 6161) to be connected to the BMX-3. "YES" allows only two disk drives (6160 or 6161) to be connected.

## 2.11 BMX-3 CONFIGURATOR

The BMX-3 Controller is configured for your particular system via software. Before you will be able to access your disk(s), the BMX-3 Controller must be configured to reflect your requirements. To do this, load the BMX-3 Configurator Program from the Software Support Package tape per instructions in the preceding section. The Configurator Program is located on File #2 of the tape.

The Program displays a heading and an introduction. Read the introduction carefully before proceeding.

Initially you must specify on which device code the BMX-3 controller is currently running. This is so that the current configuration facts can be read from the Controller's EEPROM (Electrically Erasable Programmable Read Only Memory). If this is the initial installation, the BMX-3 will be set at device code 27 octal. See Section 2.3.4 for device code selection.

The BMX-3 Configurator Program includes both a HELP menu for general questions and a HELP command for each item. Please use these functions whenever you are uncertain as to what to do. The purpose of the Configurator is to change the pre-set facts to reflect your environment, and then to update the EEPROM on the Controller. The Controller will then perform according to the particular configuration you have specified.

## SYSTEM REQUIREMENTS TO RUN CONFIGURATOR PROGRAM

- a) Nova/Eclipse or MV Family CPU with 32K Words Memory
- b) BMX-3 Controller Board/s
- c) Console on Device 10/11
- d) Printer at 17, in order to use Logging

The following sections describe the configurable features supported by the BMX-3.

### 2.11.1 DATA TRANSFER MODE

The BMX-3 can be configured for either Data Channel transfer or Burst Multiplexor Channel transfer. BMC mode is required for AOS/VS.

### 2.11.2 BMC BUS PRIORITY

The BMX-3 has the capability of functioning with up to seven other BMC peripheral controllers. However, some D.G. computers, such as the MV/4000 and S-280 only support up to four BMC devices. In this case you must select priorities 0 thru 3, 3 being the highest priority. The lower the priority number the lower the priority level. If there is more than one BMC device, make sure you select a priority level that is different than the other BMC devices.

### 2.11.3 DISK CONFIGURATION

The BMX-3 is capable of running with virtually any disk drive that meets the SMD specifications, including ESMD and the 20 Mhz HSMD drives. Traditionally, when running under AOS or AOS/VS, only those drives that met the sizing characteristics of the supported emulations could be used. However, Virtual Mapping circumvents many of these operating system restrictions, and allows higher formatted yields from some drives that normally map out inefficiently. Under RDOS, the BMX-3 can take advantage of the full capacity of most disk drives using ZETACO'S CSDKINIT program which allows deviation from the standard DG disk emulations.

#### DUAL VOLUME DRIVES:

If a dual volume drive is to be connected, the drive must be configured to an even-numbered unit. A dual volume drive is treated as two logical units, so a maximum of two dual volume drives, or one dual volume drive and two single volume drives can be connected.

NOTE: The Kismet Family - 6160, 6161 and 6214, under AOS. and AOS/VS, only allow two, single-volume drives or one dual-volume to be connected.

There are two forms of dual volume drives. One has two physical volumes. (Examples are CDC Lark, Amcodyne 7110 and CDC 9448 Series.)

The other form of dual-volume is treating one physical drive as 2 logical units (if drive characteristics permit). For example, dual 6061 emulation (AOS) operation for the Fujitsu 2351 Eagle, or dual 6161 emulation (AOS) operation for the Fujitsu 2333 drive, or Dual 6122 emulation operation for the Fujitsu 2361 drive.

In all cases, dual volume drives must have both units formatted before reading or writing.

#### 2.11.4 ERROR CORRECTION ENABLE

When this function is enabled, on-board error correction and data strobe early/late occur automatically on bad data. Also, a running count of ECC corrections and successful data strobe early or late data recoveries are logged in scratch pad memory, with a separate count for each unit. With this function disabled, ECC corrections must be handled by the software. This feature can be selected on any port.

#### 2.11.5 THROTTLE BURST RATE

This is defined as the number of word transfers that take place over either the DCH or the BMC on a single bus access. Throttle adjustment is dependent on the type of system configuration into which the Controller is installed. Too low of a throttle setting could result in slow disk performance, and too high of a setting could cause a data late on another DCH or BMC device. The BMX-3 supports 4, 8, 16, 32, 64, 128 and 256 word Burst Rates. A Burst Rate of 16 is recommended for DCH and 32 is recommended for BMC.

NOTE: If running a 20 Mhz. disk drive in a non-interleaved mode of operation, (interleave 1:1, no dual-volume, no double cylinder) for example, when running a FUJITSU 2361 with Sector Slip, use the following BMC Throttle Rate guidelines: (based on 602 bytes/sector.)

CPU MODEL	MINIMUM THROTTLE RATE
S140	256
S280	16
MV4000	128
MV6000	64
MV8000 (C, 11)	32
MV10000	64

Refer to Section 2.4.1 for additional information.

The BMX-3 allows you to select a different Burst Rate for each drive port, thereby giving the ability to fine tune the bus to a particular speed of the disk drive.

#### 2.11.6 BREAK COUNT INTERVAL

Utilized only in the BMC mode, the Break Count Interval is defined as the period of time that the BMX-3 is off the BMC bus. With the Break Count set to 0 there is an inherent 1.4 microsecond OFF time (delay between requests), which is the break count setting recommended by ZETACO. Each additional count adds 200 nanoseconds to the OFF bus time.

NOTE: The equivalent to the Break Count recommended by DG on 6160 is a setting of 25.

If there are other BMC devices present, it may be desirable to increase this count to allow more time for the other devices to access the bus. If the Break Count is set too large, slow disk performance may result. A larger Break Count also allows the CPU more memory time.

The BMX-3 allows you to set a different Break Count on each drive port, which gives the ability to fine tune the bus according to disk speed.

#### 2.11.7 SECTOR SLIP

The BMX-3 has an optional feature called Sector Slip, which provides the capability of utilizing spare sectors to skip over sectors that contain media defects. In effect, the media will appear flawless to the system, and thus reduce system overhead. If this option is to be enabled, you will need to run an optionally available Sector Slip Formatter Program. Sector Slip cannot be used on a disk with sector interleaving or one that is configured as dual-volume (two logical units). See the Sector Slip manual for more details if you purchased Sector Slip.

#### 2.11.8 SECTOR INTERLEAVE RATIO

Non-Interleave (1:1) is recommended for optimum performance, and should be sufficient on the BMC in most cases.

The BMX-3 supports any interleave from 2:1 up to 6:1 and each drive port can have a different interleave ratio. Interleaving may be desired to fine tune a system's performance. This is to avoid going a full revolution on the disk when the CPU cannot respond fast enough to catch the next consecutive sector.

If system performance is too slow to access the next consecutive sector, which is indicated by extremely slow disk performance, then an interleave factor of 2:1 or greater should be selected. To maintain optimum performance, don't select an interleave greater than is required to access the next consecutive sector in a multiple sector transfer.

### 2.11.9 MEDIA FORMAT

The BMX-3 has the capability of supporting, simultaneously, up to four different types of disk media format. This also means that each drive port could be running a totally different media format.

If ZETACO format is specified, one of three possible formats will automatically be selected according to the disk model that was specified earlier:

- ZETA 1 - Standard SMD Drives
- ZETA 2 - Fujitsu 20 MHZ Drives
- ZETA 3 - ZETACO High Speed Compatible

### 2.11.10 SYNC BYTE

The BMX-3 supports a media format that contains a header sync byte and data field sync byte, instead of just a sync bit. The sync byte provides better header address and data integrity. This sync byte is user-definable for each drive port on the BMX-3. Any value between 01 hex and FF hex is acceptable, although 93 hex (223 octal) is the recommended value. When entering a sync byte use the octal number. This feature can provide a means for disk pack access security between different disk subsystems.

### 2.12.0 VIRTUAL MAPPING

The purpose of this Section is to provide information as to the benefits of considering the use of the Virtual Mapping Feature with the BMX-3 Disk Controller. The main issue is to look into how this feature will allow additional drive types to be used with AOS and be media efficient without modifying the operating system (patching). The term AOS used in this section of the manual will mean AOS and AOS/VS. Unlike RDOS, with the advantage of ZETACO's DKINIT program, AOS requires that the drive must at least be equal to the characteristics of a DG emulation (cylinders, heads, & sectors). Non virtual mapping supports a very limited number of drives, because either the down-sized characteristics for AOS makes the drive very media inefficient or the drive cannot be sized correctly as a DG type drive. A solution to this would be to configure the controller for virtual mapping where as the only restriction is that the block size must be equal to or exceed a DG emulation block size. This form of virtual mapping is called Block Address Translation (BAT). The advantage of BAT is a drive with a maximum cylinder, head, or sector address that differs greatly from a DG drive may now be considered for AOS.

### 2.12.1 SCOPE

This Section will identify some of the drives that currently cannot support AOS without virtual mapping due to the nature of their characteristics and also having a low efficiency as compared to RDOS. The RDOS to AOS comparison will be illustrated by the aid of matrix tables. The three DG emulation groups (Zebra, Kismet, & Vulcan) will be discussed with regards to their importance to BAT. Methods of increasing capacity yield via BAT will be represented by tables.

### 2.12.2 DG DISK DRIVE SIZING CHARACTERISTICS

It is considered useful, on the drive manufacturers point of view, to determine media efficiency by comparing unformatted capacity with formatted capacity. Unformatted capacity is defined as the product of the cylinders, heads, and bytes per track. Formatted capacity relates to the type of system requirements, i.e. the number of data bytes. Data General requires that each sector must contain 512 bytes of data. Formatted also means to include a header field for sector address verification and gap fields for adhering to drive specification (PLO Sync, Read Gate Delay, Pad, etc.).

A more effective way of indicating drive capacity with respect to Data General would be to multiply the maximum characteristics (cylinder, head, and sector) times 512.

Let C = Maximum Cylinder Address  
H = Maximum Head Address  
S = Maximum Sector Address

Then: Byte Capacity = (C)(H)(S)(512)

Since 512 bytes per sector is a Data General constant it would simplify any further calculations by dropping it and then call the product block size.

Block size = (C)(H)(S)

For means of comparison, it would be appropriate to suggest that RDOS is 100% efficient. That is to say the only drive characteristic restrictions, assuming Rev. 7.0 or greater, would be 2048 cylinders, 32 heads, and 64 sectors as maximum addresses. Another way of looking at it is this is also the maximum addresses that can be represented by the program control accumulators (i.e. DOA, DOB, & DOC).

### 2.12.3 DG DISK EMULATION GROUPS

BAT is bounded by the set of DG emulation block sizes to be functional in an AOS or environment. There are seven different block sizes BAT can choose from for greatest media efficiency. The seven block sizes, as defined by the respective emulation, are divided up into three groups: 1) Zebra 2) Kismet 3) Vulcan. Table 2.4 defines each emulation and group. Please observe the symbol assigned to each individual emulation type as they will be used frequently throughout this Section.

TABLE 2.4 DG Emulation Groups

#### ZEBRA

	CYLINDERS	HEADS	SECTORS	BLOCK SIZE	SYMBOL
6060	411	19	24	187,416	Z0
6061	815	19	24	371,640	Z1
6067	815	5	24	97,800	Z7

#### KISMET

	CYLINDERS	HEADS	SECTORS	BLOCK SIZE	SYMBOL
6160	823	5	35	144,025	K0
6161	823	10	35	288,050	K1
6214	843	40	35	1,180,200	K4

#### VULCAN

	CYLINDERS	HEADS	SECTORS	BLOCK SIZE	SYMBOL
6122	815	19	35	541,975	V

### 2.12.4 RESTRICTIONS WHEN GROUPING DG EMULATIONS

When more than one unit is specified, every unit must be of the same group (i.e. Zebra's, Kismet's, & Vulcan's cannot be intermixed). When AOS sizes a drive as a Zebra, the ending disk address must be coherent to that driver. Kismet and Vulcan's require specific identifier flags when sized and expects all units to be of the same group.

### 2.12.5 SELECTING MAXIMUM ALLOWABLE BLOCK SIZE

This section explains the effectiveness of BAT, both functional and intuitive, now that the basic ground rules were discussed. A list of drive types (Table 2.7) that would be desirable with respect to virtual mapping will serve as examples for this Section. The basic principles of BAT shall provide the necessary tool in which to include other non-standard drive types not contained within this list.

Since the main attribute with this feature is its ability to increase data capacity (virtually), it would be appropriate at this time to define maximum allowable block size.

**Definition:** Maximum allowable blocksize is the maximum number of blocks that meet the requirements of AOS for a drive type whose block size is greater than or equal to a sum of one or more DG block sizes in an emulation group.

### 2.12.6 SYSTEM UNIT TO PHYSICAL DRIVE

Any one of the drives listed in Table 2.5 may be selected as an example, as they are all non-standard drive types. To best illustrate how BAT works select a drive type from the list and step it through the following procedure.

Let D = maximum block size of any drive type.

U = DG emulation block size.

x = an element within the 7 available DG block sizes.

**Drive Characteristics:** Cd = Maximum Cylinder Address  
Hd = Maximum Head Address  
Sd = Maximum Sector Address

**DG Unit Characteristics:** Cu = Maximum Cylinder Address  
411,815,823,843  
Hu = Maximum Head Address  
5,10,19,40  
Su = Maximum Sector Address  
24,35

$D = (Cd)(Hd)(Sd)$

$U = (Cu)(Hu)(Su)$

Therefore, to meet AOS requirements the drive must support greater than or equal to the number of blocks specified by a DG drive.

$D \geq U(x)$

x: Z0,Z1,Z7,K0,K1,K4,V

To make the above equation an equality a number must be added to U(x).



Let  $b$  = the number of extra blocks.

$$D = U(x) + b$$

then  $b = D - U(x)$  It will be apparent that the smallest  $b$  is what is desired.

NOTE: If  $D < U(x)$  for all of  $x$ , then the drive cannot be supported at all by AOS.

To summarize, multiply the maximum values of the cylinder, head, and sector of the drive, and then propagate through Table 2.4 to select the smallest number of extra blocks ( $b$ ).

Example: CDC XMD (see Table H.2)

$$D = 1,409,024$$

Using Table 2.4 then, for  $U(x)$ ,  $x = K4$  (6214 emulation) as the choice for the smallest  $b$ .

#### 2.12.7 MEDIA EFFICIENCY

Efficiency: Once the smallest  $b$  is known, media efficiency can be calculated.

$$\text{Eff} = U/D, \quad \text{Eff \%} = \text{Eff} \times 100$$

Example: CDC XMD

$$\begin{aligned} \text{Eff} &= U/D = 1,180,200 / 1,409,024 = .838 \\ \text{Eff\%} &= .838 \times 100 = 83.8\% \end{aligned}$$

Table 2.5 Virtual Mapping Example Table for Non-DG Sized Drive Types

MANUFACTURER	DRIVE CHARACTERISTICS (C,H,S)			BLOCK SIZE (D)
DRIVE TYPE	CYL (C)	HD (H)	SECT (S)	D=(C)x(H)x(S)
CDC-FSD 9715-340	711	24	35	597,240
CDC XMD	1024	16	86	1,409,024
FUJITSU 2294	1024	16	35	573,440
FUJITSU 2312	589	7	35	144,305
FUJITSU 2298	1024	16	70	1,146,880
FUJITSU 2361	842	20	70	1,178,800
NEC 2247E	1024	5	35	179,200
NEC 2257	1024	8	35	286,720
NEC 2300	760	19	63	909,720
PRIAM 7050	1049	5	23	120,635
PRIAM 6650	1024	3	35	107,520
PRIAM 15450	1121	7	35	274,645
TECSTOR 160	700	12	35	294,000
TECSTOR 200	823	12	35	345,660
AMPEX CAP 330	1024	16	35	573,440
AMPEX 660	2048	16	35	1,146,880
AMPEX 9160	1645	5	35	287,875
CEN DATA AMS 380	845	14	55	650,650
DATA PER D1600	1116	7	35	273,420
MEGAVAULT 116	823	7	35	201,635
MEMOREX 214	589	7	35	144,305

### 2.12.8 MULTIPLE UNIT ASSIGNMENT PER DRIVE TYPE

The limitation of mapping one system unit per drive type is the fact that there are only 7 different block sizes to choose from. The number of choices of block sizes increases proportionally when more unit numbers are assigned to a drive. The respective block size of each emulation within a group may be added together. Two units may be assigned in the Kismet group; up to four units within the Zebra or Vulcan group. Table 2.6 on the following page provides a list of additive DG block sizes per number of units. Notice the increased number of block size choices.

The same methods explained in Section 2.12.5 will be also used with multiple unit assignment for top media efficiency. The starting block address for each respective logical unit assigned to a drive physically starts where the previous unit left off.

Table 2.6 DG Block Sizes By Multiple Units

ZEBRA - 6060 = Z0      KISMET - 6160 = K0      VULCAN - 6122 = V  
                   6061 = Z1                           6161 = K1  
                   6067 = Z7                           6214 = K4

NOTE: ZEBRA, KISMET, AND VULCAN CANNOT BE INTERMIXED.

A. THREE UNITS PER DRIVE

ZEBRA	BLOCK SIZE	KISMET	BLOCK SIZE	VULCAN	BLOCK SIZE
Z7,Z7	195,600	K0,K0	K1	V,V	1,083,950
Z0,Z7	285,216	K0,K1	432,075		
Z0,Z0	374,832	K1,K1	576,100		
Z1,Z7	469,440	K0,K4	1,324,225		
Z0,Z1	559,056	K1,K4	1,468,250		
Z1,Z1	743,280				

B. THREE UNITS PER DRIVE

ZEBRA	BLOCK SIZE	ZEBRA	BLOCK SIZE
Z7,Z7,Z7	293,400	Z0,Z1,Z7	656,856
Z0,Z7,Z7	383,016	Z0,Z0,Z1	746,472
Z0,Z0,Z7	472,632	Z1,Z1,Z7	841,080
Z0,Z0,Z0	562,248	Z0,Z1,Z1	930,696
Z1,Z7,Z7	567,240	Z1,Z1,Z1	1,114,920

C. FOUR UNITS PER DRIVE

ZEBRA	BLOCK SIZE	ZEBRA	BLOCK SIZE
Z7,Z7,Z7,Z7	391,200	Z0,Z0,Z0,Z1	933,888
Z0,Z7,Z7,Z7	480,816	Z1,Z1,Z7,Z7	938,880
Z0,Z0,Z7,Z7	570,432	Z0,Z1,Z1,Z7	1,028,496
Z0,Z0,Z0,Z7	660,048	Z0,Z0,Z1,Z1	1,118,112
Z1,Z7,Z7,Z7	665,040	Z1,Z1,Z1,Z7	1,212,720
Z0,Z0,Z0,Z0	749,664	Z0,Z1,Z1,Z1	1,302,336
Z0,Z1,Z7,Z7	754,656	Z1,Z1,Z1,Z1	1,486,560
Z0,Z0,Z1,Z7	844,272		

TWO UNITS PER DRIVE TYPE:

$$D \geq U(r,s) \qquad r,s : \begin{array}{l} Z0,Z1,Z7 \\ \text{or} \\ K0,K1,K4 \\ \text{or} \\ V \end{array}$$
$$U(r,s) = r + s$$

Add b to make an equality  $D = U(r,s) + b$   
or  $D = r + s + b$

Summary - Multiply the maximum characteristics of the drive, like before, and compare that value to Section A of Table 2.6 to find the smallest b ( $b = D - U$ ).

Example: CDC XMD (see Table 2.5)

$$D = 1,409,024$$

Using Table 2.6 then, for  $U(r,s)$ ,  $r = K4$  (6214 emulation) and  $s = K0$  (6160 emulation) as the choice for the smallest b. Therefore,  $U(r,s) = K0,K4 = 1,324,225$

$$\text{Eff}\% = U/D \times 100 = 1,324,225 / 1,409,024 \times 100 = 94\%$$

as the effective capacity yield.

---

THREE UNITS PER DRIVE TYPE:

$$D \geq U(r,s,t) \qquad r,s,t : \begin{array}{l} Z0,Z1,Z7 \end{array}$$

$$U(r,s,t) = r + s + t$$

$$D = U(r,s,t) + b \quad \text{or} \quad D = r + s + t + b$$

Use Table 2.6, Section B for smallest b ( $b = D - U$ )

---

FOUR UNITS PER DRIVE TYPE:

$$D \geq U(r,s,t,u) \qquad r,s,t,u : \begin{array}{l} Z0,Z1,Z7 \end{array}$$

$$U(r,s,t,u) = r + s + t + u$$

$$D = U(r,s,t,u) + b \quad \text{or} \quad D = r + s + t + u + b$$

Refer to Section C of Table 2.6 and select the smallest b ( $b = D - U$ ).

---

One consideration that must be noted is a maximum allowable block size could have been determined entirely by the controller. However, due to the innate unit number availability from DG, the decision of how many units are to be assigned to a drive should be left up to the user. It is how the customers might want to tailor their system, in other words, acquiring more megabytes out of the drive by sacrificing unit numbers. This type of decision is discussed within the configuration program as well.

Section 2.12.12 shows a progression of media efficiency increase per manufacturer type when assigning multiple units. The efficiency is also compared without virtual mapping to illustrate the advantage of BAT.

#### 2.12.9 MAXIMUM ALLOWABLE BLOCK SIZE SUMMARIZED

Let  $b_1$ ,  $b_2$ ,  $b_3$ , &  $b_4$  be the smallest number of extra blocks ( $b$ ) for each respective number of unit assignments.

$b_1 = 1$  unit per drive  
 $b_2 = 2$  units per drive  
 $b_3 = 3$  units per drive  
 $b_4 = 4$  units per drive

then

$M =$  the smallest element of  $b_1, b_2, b_3, b_4$

#### 2.12.10 MEDIA FLAW

A media flaw detected by the controller is presented to the system when a DIA is issued (read data transfer status register) and the appropriate error flag is set (each ECC or surf/sect error). To know where the media flaw was detected on the disk disk surface, the system reads the ending disk address from the controller (DIC). The ending address will be represented in DG's form, not the physical address in terms of the drives cylinder, head, and sector.

#### 2.12.11 VIRTUAL MAPPING SUMMARIZED

**When to use:** When the desired disk drive is to be installed into AOS or AOS/VS and the drive characteristics (cylinders, heads, and sectors) do not meet the minimum DG emulation requirements, but the total number of blocks does.

**How to use:** Load the BMX-3 Configurator Program and follow its instructions.

## 2.12.12 VIRTUAL MAPPING YIELD PER DRIVE TYPE

The following pages contains the results of calculating the efficiency gained by using BAT. Each page is categorized by manufacturer type. E-TYPE means the DG emulation chosen for top media efficiency; the word LESS indicates that the efficiency percentage is less than the calculation above it.

TABLE 2.7 Drive Types

DRIVE MANUFACTURER: CDC

I. DRIVE CHARACTERISTICS AND RDOS BLOCK SIZE

I. DRIVE CHARACTERISTICS AND RDOS BLOCK SIZE			
FSD 9715-340		CDC-XMD	
CYL	711	1024	
HD	24	16	
SECT	35	86	
BLK SIZE	597,240	1,409,024	

II. AOS CAPACITY WITHOUT VIRTUAL MAPPING

II. AOS CAPACITY WITHOUT VIRTUAL MAPPING			
Z0		K1,K1	
E-TYPE	Z0	K1,K1	
EFF %	33.4	41.0	

III. 1 SYSTEM UNIT PER PHYSICAL UNIT (min blk size = 97,800)

III. 1 SYSTEM UNIT PER PHYSICAL UNIT (min blk size = 97,800)			
V		K4	
E-TYPE	V	K4	
EFF %	90.8	83.8	

IV. 2 SYSTEM UNITS PER PHYSICAL UNIT (min blk size = 195,600)

IV. 2 SYSTEM UNITS PER PHYSICAL UNIT (min blk size = 195,600)			
K1,K1		K4,K0	
E-TYPE	K1,K1	K4,K0	
EFF %	96.5	94.0	

V. 3 SYSTEM UNITS PER PHYSICAL UNIT (min blk size = 293,400)

V. 3 SYSTEM UNITS PER PHYSICAL UNIT (min blk size = 293,400)			
E-TYPE			
EFF %	LESS		

VI. 4 SYSTEM UNITS PER PHYSICAL UNIT (min blk size = 391,200)

VI. 4 SYSTEM UNITS PER PHYSICAL UNIT (min blk size = 391,200)			
E-TYPE			
EFF %	LESS		



DRIVE MANUFACTURER: FUJITSU

I. DRIVE CHARACTERISTICS AND RDOS BLOCK SIZE

	2294	2298	2312	2361
I CYL	1024	1024	589	842
I HD	16	16	7	20
I SECT	35	70	35	70
I BLK SIZE	573,440	1,146,880	144,305	1,178,800

II. AOS CAPACITY WITHOUT VIRTUAL MAPPING

I E-TYPE	K1	K1,K1	NA	V,V
I EFF %	50.2	50.2	0	

III. 1 SYSTEM UNIT PER PHYSICAL UNIT (min blk size = 97,800)

I E-TYPE	V	V	K0	K4
I EFF %	94.5	47.2	99.8	100.0

IV. 2 SYSTEM UNITS PER PHYSICAL UNIT (min blk size = 195,600)

I E-TYPE	Z0,Z1	V,V	
I EFF %	97.5	94.5	

V. 3 SYSTEM UNITS PER PHYSICAL UNIT (min blk size = 293,400)

I E-TYPE	Z1,Z7,Z7	Z1,Z1,Z1	
I EFF %	98.9	97.2	

VI. 4 SYSTEM UNITS PER PHYSICAL UNIT (min blk size = 391,200)

I E-TYPE	Z0,Z0,Z0,Z7	Z0,Z0,Z1,Z1	
I EFF %	99.5	97.5	

DRIVE MANUFACTURER: NEC

I. DRIVE CHARACTERISTICS AND RDOS BLOCK SIZE

	2247E	2257	2300	
CYL	1024	1024	760	
HD	5	8	19	
SECT	35	35	63	
BLK SIZE	179,200	286,720	909,720	

II. AOS CAPACITY WITHOUT VIRTUAL MAPPING

E-TYPE	K0	K0	Z0,Z0	
EFF %	80.4	50.2	41.2	

III. 1 SYSTEM UNIT PER PHYSICAL UNIT (min blk size = 97,800)

E-TYPE	K0	Z0	V	
EFF %	80.4	65.4	59.6	

IV. 2 SYSTEM UNITS PER PHYSICAL UNIT (min blk size = 195,600)

E-TYPE	Z0,Z7	Z1,Z1	
EFF %	99.5	63.3	

V. 3 SYSTEM UNITS PER PHYSICAL UNIT (min blk size = 293,400)

E-TYPE	Z1,Z1,Z7	
EFF %	92.5	

VI. 4 SYSTEM UNITS PER PHYSICAL UNIT (min blk size = 391,200)

E-TYPE	Z0,Z0,Z1,Z7	
EFF %	92.8	

DRIVE MANUFACTURER: PRIAM

I. DRIVE CHARACTERISTICS AND RDOS BLOCK SIZE

	7050	6650	15450	
I CYL	1049	1024	1121	
I HD	5	3	7	
I SECT	23	35	35	
I BLK SIZE	120,635	107,520	274,645	

II. AOS CAPACITY WITHOUT VIRTUAL MAPPING

	NA	NA	K0	
I E-TYPE	NA	NA	K0	
I EFF %	0	0	52.4	

III. 1 SYSTEM UNIT PER PHYSICAL UNIT (min blk size = 97,800)

	Z7	Z7	Z0	
I E-TYPE	Z7	Z7	Z0	
I EFF %	81.1	91.0	68.2	

IV. 2 SYSTEM UNITS PER PHYSICAL UNIT (min blk size = 195,600)

			Z7,Z7	
I E-TYPE			Z7,Z7	
I EFF %			71.2	

V. 3 SYSTEM UNITS PER PHYSICAL UNIT (min blk size = 293,400)

I E-TYPE				
I EFF %				

VI. 4 SYSTEM UNITS PER PHYSICAL UNIT (min blk size = 391,200)

I E-TYPE				
I EFF %				

DRIVE MANUFACTURER: TECSTOR

I. DRIVE CHARACTERISTICS AND RDOS BLOCK SIZE

	160	200		
I CYL	700	823		
I HD	12	12		
I SECT	35	35		
I BLK SIZE	294,000	345,660		

II. AOS CAPACITY WITHOUT VIRTUAL MAPPING

I E-TYPE	NA	K1		
I EFF %	0	83.3		

III. 1 SYSTEM UNIT PER PHYSICAL UNIT (min blk size = 97,800)

I E-TYPE	K1	K1		
I EFF %	98.0	83.3		

IV. 2 SYSTEM UNITS PER PHYSICAL UNIT (min blk size = 195,600)

I E-TYPE				
I EFF %	LESS	LESS		

V. 3 SYSTEM UNITS PER PHYSICAL UNIT (min blk size = 293,400)

I E-TYPE	Z7,Z7,Z7	Z7,Z7,Z7		
I EFF %	98.8	84.9		

VI. 4 SYSTEM UNITS PER PHYSICAL UNIT (min blk size = 391,200)

I E-TYPE				
I EFF %				

DRIVE MANUFACTURER: AMPEX

I. DRIVE CHARACTERISTICS AND RDOS BLOCK SIZE

	CAP 330	660	9160	
CYL	1024	2048	1645	
HD	16	16	5	
SECT	35	35	35	
BLK SIZE	573,440	1,146,880	287,875	

II. AOS CAPACITY WITHOUT VIRTUAL MAPPING

E-TYPE	K1	K1	K0	
EFF %	50.2	25.1	50.0	

III. 1 SYSTEM UNIT PER PHYSICAL UNIT (min blk size = 97,800)

E-TYPE	V	V	Z0	
EFF %	94.5	47.3	65.1	

IV. 2 SYSTEM UNITS PER PHYSICAL UNIT (min blk size = 195,600)

E-TYPE	Z0,Z1	V,V	Z0,Z7	
EFF %	97.5	94.5	99.1	

V. 3 SYSTEM UNITS PER PHYSICAL UNIT (min blk size = 293,400)

E-TYPE	Z1,Z7,Z7	Z1,Z1,Z7		
EFF %	98.9	97.2		

VI. 4 SYSTEM UNITS PER PHYSICAL UNIT (min blk size = 391,200)

E-TYPE	Z0,Z0,Z0,Z7	Z0,Z0,Z1,Z1		
EFF %	99.5	97.5		

DRIVE MANUFACTURER: CENTURY DATA

I. DRIVE CHARACTERISTICS AND RDOS BLOCK SIZE

	AMS 380	AMS 571		
I CYL	845	941		
I HD	14	19		
I SECT	55	57		
I BLK SIZE	650,650	1,019,103		

II. AOS CAPACITY WITHOUT VIRTUAL MAPPING

E-TYPE	K1,K1	V		
I EFF %	88.5	53.2		

III. 1 SYSTEM UNIT PER PHYSICAL UNIT (min blk size = 97,800)

E-TYPE	V	V		
I EFF %	83.3	53.2		

IV. 2 SYSTEM UNITS PER PHYSICAL UNIT (min blk size = 195,600)

E-TYPE	K1,K1	Z1,Z1		
I EFF %	88.5	72.9		

V. 3 SYSTEM UNITS PER PHYSICAL UNIT (min blk size = 293,400)

E-TYPE		Z0,Z1,Z1		
I EFF %	LESS	91.3		

VI. 4 SYSTEM UNITS PER PHYSICAL UNIT (min blk size = 391,200)

E-TYPE		Z1,Z1,Z7,Z7		
I EFF %	LESS	92.1		

DRIVE MANUFACTURER: DATA PERIPHERAL

I. DRIVE CHARACTERISTICS AND RDOS BLOCK SIZE

	D1600			
CYL	1116			
HD	7			
SECT	35			
BLK SIZE	273,420			

II. AOS CAPACITY WITHOUT VIRTUAL MAPPING

E-TYPE	K0			
EFF %	68.5			

III. 1 SYSTEM UNIT PER PHYSICAL UNIT (min blk size = 97,800)

E-TYPE	K0			
EFF %	68.5			

IV. 2 SYSTEM UNITS PER PHYSICAL UNIT (min blk size = 195,600)

E-TYPE	Z7,Z7			
EFF %	71.5			

V. 3 SYSTEM UNITS PER PHYSICAL UNIT (min blk size = 293,400)

E-TYPE				
EFF %				

VI. 4 SYSTEM UNITS PER PHYSICAL UNIT (min blk size = 391,200)

E-TYPE				
EFF %				

DRIVE MANUFACTURER: MEGAVULT

I. DRIVE CHARACTERISTICS AND RDOS BLOCK SIZE

	116			
I CYL	823			
I HD	7			
I SECT	35			
I BLK SIZE	201,635			

II. AOS CAPACITY WITHOUT VIRTUAL MAPPING

I E-TYPE	K0			
I EFF %	71.4			

III. 1 SYSTEM UNIT PER PHYSICAL UNIT (min blk size = 97,800)

I E-TYPE	Z0			
I EFF %	92.9			

IV. 2 SYSTEM UNITS PER PHYSICAL UNIT (min blk size = 195,600)

I E-TYPE	Z7,Z7			
I EFF %	97.0			

V. 3 SYSTEM UNITS PER PHYSICAL UNIT (min blk size = 293,400)

I E-TYPE				
I EFF %				

VI. 4 SYSTEM UNITS PER PHYSICAL UNIT (min blk size = 391,200)

I E-TYPE				
I EFF %				



DRIVE MANUFACTURER: MEMOREX

I. DRIVE CHARACTERISTICS AND RDOS BLOCK SIZE

	213	214	
I CYL	589	589	
I HD	4	7	
I SECT	35	35	
I BLK SIZE	82,460	144,305	

II. AOS CAPACITY WITHOUT VIRTUAL MAPPING

I E-TYPE	NA	NA	
I EFF %	0	0	

III. 1 SYSTEM UNIT PER PHYSICAL UNIT (min blk size = 97,800)

I E-TYPE		K0	
I EFF %		99.8	

IV. 2 SYSTEM UNITS PER PHYSICAL UNIT (min blk size = 195,600)

I E-TYPE			
I EFF %			

V. 3 SYSTEM UNITS PER PHYSICAL UNIT (min blk size = 293,400)

I E-TYPE			
I EFF %			

VI. 4 SYSTEM UNITS PER PHYSICAL UNIT (min blk size = 391,200)

I E-TYPE			
I EFF %			



### 3.0 TROUBLE-SHOOTING

The BMX-3 is supported by ZETACO in the following ways:

- Microprocessor based selftest of over 90% of the board each time it is powered up, with an LED status report.
- Reliability and Diagnostic program on 9-track tape for use during installation and trouble-shooting.
- 48-hour turn-around on most factory repairs or replacement.
- Up to a two year warranty on workmanship and materials.
- Customer support available from factory-trained personnel in our Authorized Distributor and Authorized Service organizations, as well as ZETACO's Customer Support Hotline.
- ZETACO's Customer Support Hotline, manned from 8:00 a.m. to 5:00 p.m. (Central Time) to answer your questions. (612-941-9480)

### 3.1 SELF TEST

Self-test checks out 90% of all the internal functions of the controller board once for every time power is applied to the board. The test takes approximately 1/2 second to execute.

If Self-test passed, the red LED will go out. If a failure was detected, the LED will blink a number of times which corresponds to the subtest that failed. This error code will be repeated six times and then the microprocessor will start looping on the failing subtest with the LED constantly on. Depressing the front panel IORESET switch will cause the LED to blink the error code over again.

TABLE 3.1 Self Test Errors

CODE	TEST	POSSIBLE FAILURE
1	EEPROM TEST	The data in the EEPROM did not compare with expected data (55 hex). EEPROM may not have been previously burned.
2	RAM TEST	Data read from RAM did not compare with data written. 2149, PBUS or RAM data bus may be bad.
3	BMC BUFFER TEST	Data transfer to and from the BMC buffer did not compare with the original data in buffer 0.
3	2940 ADDRESS GENERATOR TEST	Data read from 2940's did not compare with data written. 2940 may be bad.
4	CONDITION FF, BIT TEST & 32 BIT SHIFT TEST	The state of the condition flip flops were not correct. Command Full, Busy, Done, Control Full, Overflow (2901), DCHDN (2940) may be bad. The bit testing logic may have failed. The bit shifting mechanism may have failed. (2901)
5	SEQUENCE ERROR TEST	A forced sequence error did not occur within a specified amount of time. Format sequencer may be bad. (No Clock)

6	SYNC DETECT TEST	A sync detect was not made in a specified amount of time or the terminate FF may not have set. The sync register or compare logic may be bad or the terminate FF may be bad.
7	ECC TEST	The generated ECC pattern did not compare with the expected pattern. The shift registers, ECC logic, or multiplexers may be bad.

If the Self-test LED does not blink or go out, then the 2925 clock circuitry, the 2910 or the power fail circuit may be bad. Another possible reason for the red LED to be on continuously is if +5v supplied from the backplane is below 4.75v.

### 3.2 SOFTWARE: DIAGNOSTICS AND UTILITIES

In addition to the diagnostic functions provided by the BMX-3 Controller via on-board Self-test, ZETACO provides Diagnostic and utility software. The Software Support Package magnetic tape included with the controller contains these programs.

Each of the programs on the Software Support Package tape have been written by ZETACO specifically for the BMX-3 Controller. You should use this tape for media formatting, Disk Diagnostics and Reliability, Configuring and RDOS Utilities. D.G.'s corresponding programs may not work on this controller. The disk media formatter on the Software Support Package tape will let you format the media in any of the formats.

#### 3.2.1 USING THE SOFTWARE SUPPORT PACKAGE TAPE

The Software Support Package tape is structured so that the programs on Files 2-7 can be loaded and executed directly from the tape. Files 0 and 1 contain the software which enables you to boot from the tape and select the particular program you want loaded into the system. Each of the programs on Files 2-7 is a stand-alone program. This means that they do not need, and cannot have, an operating system running when they are executed.

Programs cannot be loaded onto your disk directly from Files 0-7. File 8 for RDOS and File 9 for AOS or AOS/VS contain the programs in the standard system dump format and you can load them from these files to your disk. Even after the programs have been transferred to your disk, retain the Software Support Package tape in case of disk subsystem problems.

The following sequence of events is recommended by ZETACO. Each step is described in greater detail in the subsequent sections of this chapter.

1. Mount the Software Support Package tape and boot it.
2. Select #2 on Tape Menu - Configure the Controller.
3. Select #4 - Format the Media. (Usually required.)
4. Select #3 - Disk Diagnostics.
5. Select #5 - Disk Reliability.

NOTE: It is not essential that you run Diagnostics or Reliability, however, they will locate disk subsystem problems. It is better that this be checked out at this point than after you have loaded your data.

6. If the controller is to run in an RDOS system, select #6 to initialize the disk. If the controller will not run in an RDOS system, proceed to the disk initializer program on the DG system tape for your operating system.
7. You can load the programs from File 8 or File 9 any time after you have built your disk.

The Bootstrap Procedure for the Software Support Package tape is:

1. Mount the Software Support Package tape on the drive and put it on-line. Be sure that the BPI setting matches that specified on the tape label.
2. Program Load - The method of program load varies for the different processors. Some of the possibilities are described here.

If your system has front-panel switches, set them to 100022 when loading from the primary tape drive, or to 100062 when loading from the secondary tape drive. Then press reset and the program load switch.

For the S140 virtual console, set 11A to 100022 (or 100062 for secondary tape drive). Then enter 100022L (or 100062L).

For the S120 virtual console, enter 22H (or 62H for the secondary tape drive).

For MV class CPU's you must enter the full virtual console and respond to the prompt:

```
SCP-CLI>
with BOOT 22 (or 62 for secondary tape)
```

3. The Software Support Package Menu will be displayed:

FILE #	PROGRAM
2	BMX-3 Configurator
3	Disk Diagnostics
4	Disk Formatter
5	Disk Reliability
6	ZDKINIT-RDOS Disk Initializer
7	ZDSKED-RDOS Disk Editor
8	".SV & .LS" Files and any Utilities in RDOS Dump Format
9	".SV & .LS" Files and any Utilities in AOS Dump Format
10	AOS/VS Utilities in AOS Dump Format

File Number?

Enter the file number of the program you wish to execute.

To load files from File 8 or 9, use the standard CLI Command for loading from tape.

```
RDOS:  DIR %MDIR%
        INIT MTO
        LOAD/A/R/V MTO:8
        RELEASE MTO
```

```
AOS:   SUPERUSER ON
        DIR :
        LOAD/R/V @MTA0:9
        REW @MTA0
        SUPERUSER OFF
```

```
AOS/VS: SUPERUSER ON
         DIR :
         LOAD/R/V @MTC0:9
         DELETE/V A0SECC.PR
         LOAD/R/V @MTC0:10
         REW @MTC0
         SUPERUSER OFF
```

### 3.2.2 DISK FORMATTER

The Disk Formatter Program, contained in File #4, is a program designed to format and check disk media. File #4, in conjunction with the BMX-3 hardware, supports these media formats: ZETA1, ZETA2, and ZETA3.

It is recommended that on-board error correction for each drive be disabled throughout both formatter and initializer programs. It should then be enabled by running the Configurator again after disk initialization.

The following is a sample dialogue:

ZETACO SMD DISK CONTROLLER FORMATTER REV. XX

STARTING ADDRESSES:

500-FORMATTER/CHECK PROGRAM  
501-CHECK PROGRAM ONLY  
502-ERROR LOG RECOVERY  
503-COMMAND STRING INTERPRETER

ENTER DEVICE CODE [27]: 67

SET SWPAK AS PER APPENDIX E, LISTING (WHITE PAGES) SECTION 8.0  
OR HIT (CR) TO CONTINUE

START TIME? - MON, DAY, YR HR, MIN

# PASSES TO FORMAT COMPLETION? - 6

UNIT	TYPE	HDS	CYLS	SEC/TRK	SECTOR PULSES
0	0	5	823	32	32
2	1	5	815	24	24

ENTER UNIT NUMBERS (0,1,2,3) TO RUN: 0,2

UNIT: 0

ENTER TYPE OF DISK: 0

UNIT: 2

ENTER TYPE OF DISK: 1

FORMATTING UNIT 0,2

See formatter text at end of manual for further details.



### 3.2.2.1 FORMATTER ERROR DESCRIPTION

Errors found during surface analysis are displayed after the header fields are written and "formatting done" has been output to the console. These errors are displayed when they are detected. The controller status will be displayed with the particular problem spelled out below the status. Each status bit is explained in the programming section but since the error is also spelled out, referencing the programming section may not help. Most errors that can occur are servo, address, ECC or ready errors.

### 3.2.2.2 SERVO CLOCK FAULTS

A servo clock fault will terminate the format program. Note the cylinder, head and sector on which the error was detected, printed out on the console before aborting.

Use the command string interpreter, explained in the appendix, to seek to the cylinder noted above. Next, do a write to the head and sector (transfer one sector) noted above. If it again errs, it is not intermittent. Now try writing to other sectors around the sector that erred. If these sectors also err, there are not enough bytes per sector (need 576 minimum) and the disk drive's technical manual should be consulted to check the number of bytes per sector.

Another cause of this error could be improperly connected cables or the sector and index pulses were transmitted over the "B" cable and not the "A" cable. If these errors are intermittent, again check for improper cable connections and re-check the disk type for which the controller is configured, using the Configurator Program as a tool.

### 3.2.2.3 ECC-DETECTED ERRORS

There are two types of ECC-detected errors: those with data printed out with the error and those without data printed out with the error. ECC errors will not abort the program. These errors usually mean the controller detected a flaw in the disk media.

ECC-detected errors with data printed out with the error: Up to three words of the data that should be on the disk, (good data) and the data that is on the disk (bad data), is printed out along with a count number. This count number is the number of words found in the sector that are bad.

For example, if there are six words that are bad in one sector, the first three bad words will be printed out with the good and bad data and the count will be six. The formatter program automatically flags these sectors bad so the operating system does not try to use this bad media.

ECC-detected errors without data words printed out with the error means there is a bad spot on the media where the ECC words are written. The formatter automatically flags these sectors as bad.

If the ECC-detected errors without data printed out are excessive, such as every sector, there may be too few bytes per sector, causing this problem. Use the disk drive's technical manual to check the number of bytes per sector on the disk drive with the present sector setting. 576 bytes per sector (or more) are required to run the BMX-3.

### 3.2.2.4 ECC-UNDETECTED ERRORS

ECC-undetected errors will terminate the formatter program. Note the cylinder, head and sector on which the error occurred; also note the count number. Load the Configurator Program and verify that the controller is configured for the right disk drive(s).

If the configuration is correct, load the Formatter Program again and bring up the command string interpreter, which is explained in the appendix. Use the command string to seek to the cylinder noted above. Next, write to the head and sector (transfer one sector) noted above. This helps verify that the problem is not intermittent.

Now format the noted sector and then write to it again. If the error is still there, power down the system and power it back up. Examine the Self-test LED (red) for any Self-test errors. If there are none, try the BMX-3 in another slot.

### 3.2.2.5 SURFACE OR SECTOR ADDRESS ERRORS

Surface/Sector address errors do not abort the format program. These errors usually indicate bad media in the header field. The formatter will automatically flag these sectors bad. If these errors are intermittent or excessive, check for poor disk termination, improper disk cabling or grounding, and re-check the controller configuration for the correct disk types.

### 3.2.2.6 LOSS OF READY

"Loss of Ready" errors abort the format program. They can be caused by improper cabling or termination. These errors indicate the disk unit was not ready when a command was issued. Check that the disk drive is powered up and no faults have occurred on it.

### 3.2.2.7 DEFAULT PARAMETERS

Default parameters exist when the controller does not see a unit selected from the disk drive. This communication problem between the controller and the disk unit can be caused by improper cabling, poor termination or grounding, or a bad disk drive.

When you start Formatter or Reli and the following information displays on the screen, what characteristics are shown?

UNIT	TYPE	HDS	CYLS	SEC/TRK	SECTOR PULSES
------	------	-----	------	---------	---------------

Example of characteristics for one drive (CDC 9766) connected:

UNIT	TYPE	HDS	CYLS	SEC/TRK	SECTOR PULSES
0	0	19	815	35	35

If you are connecting one disk drive and four drives appear on the screen, your drive is not recognized by the controller due to:

1. DRIVE OFF LINE
2. CABLES NOT CONNECTED
3. BAD CABLE(S)
4. INCORRECT CABLING SEQUENCE (Is Yellow LED ON?)
5. CALLING UP WRONG DEVICE CODE OR NON-EXISTENT DEVICE CODE
6. INTERRUPT AND PRIORITY CHAIN BROKEN
7. TERMINATOR OF DISK DRIVE NOT IN

Default Example:

UNIT	TYPE	HDS	CYLS	SEC/TRK	SECTOR PULSES
0	1	5	815	35	35
1	2	10	823	35	35
2	3	19	815	35	35
3	4	40	843	35	35

3.2.2.8 ADDITIONAL INFORMATION FOR ALL PROBLEMS

For any error encountered while formatting, it is beneficial to try a different "B" port. This isolates some logic on the controller that cannot be checked by Self-test.

3.2.2.9 SLOW FORMAT

The Formatter Program takes about 56 minutes to format 300MB, (1 pass), and time is directly proportional to the disk size. If it takes more time than this, the disk is probably skipping revolutions. To alleviate this problem, re-configure the controller to interleave the disk.

3.2.3 DISK DIAGNOSTIC

This Diagnostic program is provided to find failures that are related to the basic operations of the disk controller. The ID bits (AOS) shown in the sample below will aid in checking the configuration.

Load the File #3 from Software Support Package tape provided. (See Using the Software Support Package Tape in Section 3.0).

The following is a sample dialogue for 6160 (AOS):

ZETACO SMD DISK CONTROLLER DIAGNOSTIC REV. XX

STARTING ADDRESSES:

200-DIAGNOSTIC (INITIALIZE)  
201-DIRECT ODT ENTRY  
202-RANDOM SEEK EXERCISERS  
    SEEK EXER 1 IS A SINGLE DRIVE EXERCISER  
    SEEK EXER 2 IS A TWO DRIVE EXERCISER WITH SEEK OVERLAP  
500-DIAGNOSTIC (RESTART)

ENTER DEVICE CODE [27]: 67

ANY DUAL VOLUME UNITS? ENTER 1

ENTER UNIT NUMBERS (0,1,2,3) TO RUN: 0,1

SET SWPAK AS PER APPENDIX E.1, 8.0 IN LISTING (WHITE PAGES) OR  
ENTER RETURN (CR) TO CONT.

## TESTING UNIT 0

.  
. .  
. .  
. .

UNIT	HDS	CYLS	SEC/TRK	SECTOR PULSES
0	5	823	35	35

These are the units and characteristics found, do you want to loop on reading them? Enter 1, otherwise enter Return (CR).

.  
. .  
. .  
. .

See Diagnostic text at the end of the manual for further details.

ADDRESSABLE SECTORS/TRACK WITH THIS CONTROLLER IS 64.  
DRIVE UNIT #0 WILL BE IDENTIFIED AS A 6160 (73 MBYTE)  
BY AOS OR AOS/VS.  
DRIVE UNIT #1 WILL BE IDENTIFIED AS A 6160 (73 MBYTE)  
BY AOS OR AOS/VS.  
TEST(S) COMPLETE.  
SEEK EXERCISER TESTS.  
PASS

### 3.2.3.1 DIAGNOSTIC ERROR DESCRIPTION

When the diagnostic detects an error, it prints out the test number that failed along with what is wrong. Use the SWPACK register to help determine whether or not the error is intermittent. This is done by setting switch 3, which prints out an error percentage.

Appendix E, Section E.1, describes the meaning of the bits in the SWPACK register. Depressing the M key allows the user to observe the contents of this register.

### 3.2.3.2 SERVO OFFSET FORWARD

Servo offset "forward" errors can occur in the diagnostic if the disk unit does not support the offset command. This type of error is also caused by a disk drive that returns a write protect to the controller during an offset. The technical manual for the disk unit should be consulted to determine whether your disk can exhibit the offset problem. If it does, this error is invalid and can be overlooked.

### 3.2.3.3 SERVO OFFSET REVERSE

Servo offset "reverse" errors can occur in the diagnostic if the disk unit does not support the offset command.

This type of error is also caused by a disk drive that returns a write protect to the controller during an offset. The technical manual for the disk unit should be consulted to determine whether your disk can exhibit the offset problem. If it does, this error is invalid and can be overlooked.

### 3.2.4 DISK RELIABILITY

The Disk Reliability program is a maintenance program designed to exercise and test the disk subsystem. The program will test from one to four drives. Boot the Disk Reliability Program from File #5 in the Software Support Package tape.

Refer to Appendix D for evoking the command string interpreter.

The following is a sample dialogue:

ZETACO...DISK RELIABILITY REV. XX

STARTING ADDRESSES:

500-RELIABILITY TEST  
501-RELIABILITY TEST WITH OPTIONS  
502-DISK ADDRESS TEST  
503-COMMAND STRING INTERPRETER  
504-FORMAT ONLY  
505-RUN ALL TESTS  
506-SEEK EXERCISER  
507-RANDOM SEEK EXERCISER  
510-ERROR COUNT/LOG RECOVERY

ENTER DEVICE CODE [27]: 67

STARTING ADDRESS = 505

SET SWPAK AS PER APPENDIX E.1 OR 8.0 LISTINGS (WHITE PAGES) OR HIT (CR) TO CONTINUE.

ARE MAPS TO BE EXERCISED (YES/NO)? YES

START TIME? - MON, DAY, YR HR, MIN

ANY DUAL VOLUME UNITS (YES/NO)? NO

UNIT	TYPE	HDS	CYLS	SEC/TRK	SECTOR PULSES
0	0	5	823	32	32
2	1	5	815	24	24

ENTER UNIT NUMBERS (0,1,2,3) TO RUN: 0,1

UNIT: 0

ENTER TYPE OF DISK: 0

UNIT: 1

ENTER TYPE OF DISK: 1

TESTING UNIT 0,1

See Reliability text at the end of manual for further details.

#### 3.2.4.1 RELIABILITY ERROR DISCRPTION

Reliability errors are displayed when they are detected. The controller status will be displayed with the particular problem spelled out below the status. Each status bit is explained in the programming section but since the error is also spelled out, referencing the programming section may not help. Most errors that can occur are default or ready errors.

#### 3.2.4.2 LOSS OF READY

These errors indicate the disk unit is not ready when a command was issued. Check that the disk unit is powered up and no faults have occurred on the disk unit.

#### 3.2.4.3 DEFAULT PARAMETERS

Default parameters exist when the controller does not see a unit selected from the disk drive. This communication problem between the controller and the disk unit is usually caused by the disk unit being powered down or faulted, since this was correct in the Formatter Program.

When you start Formatter or Rell, and the following information displays on the screen, what characteristics are shown?

UNIT	TYPE	HDS	CYLS	SEC/TRK	SECTOR PULSES
------	------	-----	------	---------	---------------

Example of characteristics for one drive (CDC 9766) connected:

UNIT	TYPE	HDS	CYLS	SEC/TRK	SECTOR PULSES
0	0	19	815	35	35

If you are connecting one disk drive and four drives appear on the screen, your drive is not recognized by the controller due to:

1. DRIVE OFF LINE
2. CABLES NOT CONNECTED
3. BAD CABLE(S)
4. INCORRECT CABLING SEQUENCE (Is Yellow LED ON?)
5. CALLING UP WRONG DEVICE CODE OR NON-EXISTENT DEVICE CODE
6. INTERRUPT AND PRIORITY CHAIN BROKEN
7. TERMINATOR OF DISK DRIVE NOT IN

Default Example:

UNIT	TYPE	HDS	CYLS	SEC/TRK	SECTOR PULSES
0	1	5	815	35	35
1	2	10	823	35	35
2	3	19	815	35	35
3	4	40	843	35	35

#### 3.2.4.4 ADDITIONAL INFORMATION FOR ALL PROBLEMS

For any error encountered while formatting, it is beneficial to try a different "B" port. This isolates some logic on the controller that cannot be checked by Self-test.

#### 3.2.5 CSDKINIT - RDOS DISK INITIALIZER

(ZETACO's version of DKINIT, referred to as CSDKINIT, is supplied on the Software Support Package tape File #6.)

Initializing a Model BMX-3 disk:

Before you load any RDOS system onto a Model BMX-3, YOU MUST INITIALIZE THE DISK BY RUNNING CSDKINIT. This is a stand-alone program that performs all the functions of D.G.'s DKINIT. Please refer to D.G. manual on loading an RDOS system for full details on the functionality of disk initialization.

Remember that only CSDKINIT will work correctly for Model BMX-3 controllers. If you are building your system from an RDOS release tape, do NOT run File #4 on the D.G. tape after running CSDKINIT. D.G.'s DKINIT cannot be run in expanded emulation on a BMX-3. CSDKINIT can, however, be used to initialize any DG supported disk.

STEP 1 - LOADING

A) If loading from a Software Support Package tape:

Perform the steps described for loading the tape in Section 3.2.1



YOU RESPOND:

6

B) If loading from disk: (CSDKINIT.SV must have been previously loaded onto the disk.

Mount the disk pack which contains CSDKINIT.

Set console switches to correct device code.

Press RESET and LOAD switches.

PROGRAM DISPLAYS:

FILENAME?

YOU RESPOND:

CSDKINIT (or DIR:CSDKINIT, if the program file is located in directory, DIR, other than the master).

STEP 2 - DISK TYPE

PROGRAM DISPLAYS:

DISK INITIALIZER - REV. NN.NN/with ZETACO Disk  
Support-REV. 1  
DISK DRIVE MODEL NUMBER?

YOU RESPOND:

6XXX

NOTE: Enter the X's as shown above.

A) If the disk type is not valid-

PROGRAM DISPLAYS:

ILLEGAL DISK TYPE

Step 2 will be repeated until your response is acceptable.

B) If the disk type is valid -

PROGRAM DISPLAYS:

6XXX (ZETACO Emulation) Drive Type

### STEP 3 - DISK UNIT

PROGRAM DISPLAYS:

DISK UNIT?

YOU RESPOND:

DZx, where x indicates drive number: 0, 1, ..., 7

A) If the disk unit is not valid -

PROGRAM DISPLAYS:

ILLEGAL DISK UNIT DECLARATION

Step 3 will be repeated until your response is acceptable.

B) If the disk unit is valid -

PROGRAM DISPLAYS:

# HEADS	# SEC/TRK	#CYLINDERS	MGB/BLK
99	99	999	Megabytes if disk >4000 blks. Blocks if disk <4000 blks.

### STEP 4 - ECC CORRECTION

It is recommended that you disable ECC correction while running CSDKINIT, to allow the initializer to flag those bad blocks that are potential problems even though they might be correctable at the time of running CSDKINIT.

In cases where there is a need for using even marginal media, CSDKINIT can be run with ECC enabled.

### STEP 5 - COMMANDS AND SUBSEQUENT OUTPUT

The commands which can be selected are identical to those of DKINIT.

From this point on, CSDKINIT will perform exactly as DKINIT.

### 3.2.6 CSDSKED: RDOS STAND-ALONE DISK EDITOR

CSDSKED, found in File #7 of the Software Support Package tape, provides the same functions for the BMX-3 Controller as D.G.'s DSKED does for standard D.G. controllers. It can also be used for any D.G.-supported disk. Please refer to the D.G. stand-alone disk editor manual for a complete description of the commands.

Following are the steps necessary to run CSDSKED.

STEP 1 - LOADING

A) If loading from a Software Support Package Tape:

Perform the steps described for loading the tape in Section 3.2.1.

YOU RESPOND:

7

B) If loading from disk: (CSDSKED.SV must have been previously loaded onto the disk).

Mount the disk pack which contains CSDSKED.

Set console switches to correct device code.

Press RESET and LOAD switches.

PROGRAM DISPLAYS:

FILENAME?

YOU RESPOND:

CSDSKED (or DIR:CSDSKED, if the program file is located in directory, DIR, other than the master).

STEP 2 - DISK TYPE

PROGRAM DISPLAYS:

DISK EDIT - REV NN.NN WITH ZETACO DISK SUPPORT - REV. 1

DISK DRIVE MODEL NUMBER?

YOU RESPOND:

6XXX

NOTE: Enter the X's as shown above.

A) If the disk type is not valid -

PROGRAM DISPLAYS:

ILLEGAL DISK TYPE

Step 2 will be repeated until your response is acceptable.

B) If the disk type is valid -

PROGRAM DISPLAYS:

6XXX (ZETACO Emulation) Drive Type

STEP 3 - DISK UNIT

PROGRAM DISPLAYS:

DISK UNIT?

YOU RESPOND:

DZx, where x indicates drive number: 0, 1, ....., 7

A) If the disk unit is not valid -

PROGRAM DISPLAYS:

ILLEGAL DISK UNIT DECLARATION

Step 3 will be repeated until your response is acceptable.

B) If the disk unit is valid -

PROGRAM DISPLAYS:

# HEADS	# SEC/TRK	# CYLINDERS	MGB/BLK
99	99	999	Megabytes if disk >4000 blks. Blocks if disk <4000 blks.

STEP 4 - COMMANDS AND SUBSEQUENT OUTPUT

The commands that can be selected are identical to those of DSKED. From this point on, CSDSKED will perform exactly as DSKED.

### 3.2.7 ECC - ECC ERROR CORRECTIONS COUNTER FUNCTIONS

The Model BMX-3 Controller maintains a counter of ECC corrections for each drive connected to the controller(s). These are the corrections performed by the firmware, and are therefore invisible to the system except through these counters. The counters are automatically cleared by the reset switch on the front panel of the CPU or if the controller is powered down.

The ECC program is currently available only for RDOS and AOS (RDOSECC.SV for RDOS and AOSECC.PR for AOS). It allows you to monitor the media by displaying or modifying the counters. You may want to reset the counters to zero on some regular basis: daily, weekly, monthly, etc.

#### STEP 1 - EXECUTING THE PROGRAM UNDER CLI

##### A) RDOS Version

ENTER: RDOSECC

##### B) AOS Version

ENTER: X AOSECC

#### STEP 2 - MAIN MENU

##### CUSTOM SYSTEMS - ECC FUNCTIONS

- 1 - DISPLAY CONTROLLER ECC CORRECTIONS
- 2 - RESET CONTROLLER ECC CORRECTIONS
- 3 - STOP

NOTE - SELECT ONLY THOSE DRIVES WITH ZETACO CONTROLLERS.  
RESULTS ARE UNPREDICTABLE ON OTHER BOARDS!

ENTER SELECTION

YOU RESPOND:

- 1) To display the ECC corrections counter(s)
- 2) To modify the ECC corrections counter(s)
- 3) To terminate the program and return to the CLI

### STEP 3 - ENTERING THE UNIT

If you selected 1 or 2,

PROGRAM DISPLAYS:

ENTER UNIT:

YOU RESPOND:

DZn (n = 0, 1, ..., 7) for RDOS  
DPFN (n = 0, 1, 2, 3, 10, 11, 12, 13) for AOS  
Carriage Return or New Line to return to Main Menu.

The program will display the (decimal) value of the corrections counter for the drive selected. This step will be repeated until the response to ENTER UNIT is Carriage Return or New Line.

### STEP 4 - MODIFYING THE COUNTER

If your response to the Main Menu was 2, there will be another message after Step 3:

ENTER NEW VALUE:

You respond with the (decimal) value to which you want the counter set. The number must be between 0 and 65,535. This step will be repeated until you enter a Carriage Return or New Line, which will return you to Step 3.

## 3.3 SYSTEM ERRORS

If a system error occurs, use the User Manuals provided with the system to help determine what is wrong. For example, if a panic code is given, look up the code by referring to the D.G. User's Manual. This information could help determine how to solve the problem. Next, try to execute a similar function and see if the same results are obtained. If a burst or a copy is not working, try a dump. This could add vital information about the problem.

### 3.3.1 TEST PROGRAMS TO USE IF THE SYSTEM IS BUILT BUT PROBLEMS HAVE ARISEN

This Section explains a test that can be done on a disk that has a system or system data on it without destroying that system or data. This provides an avenue for conditions requiring diagnostic testing, but where time does not permit the luxury of being able to rebuild a system.

This test requires that the Reliability program on the Software Support Package tape be loaded into system memory.

Answer the question "enter device code" with the correct information. Next, depress control 0. An @ should be on the console. There are two different tests that can be run: a random seek test, or a sequential seek test.

To run the random seek test, enter a 501R after the prompt (@). If the sequential test is desired, enter a 502R after the prompt (@).

Now answer the questions the program asks, as in the normal reliability testing, with the exception of one question. When the question "SET SWPAK PER 8.0, OR HIT (CR) TO CONT." is asked, enter an "8" one time. This puts the program in a Read Only mode and writes will not be done. Enter an "M" to verify that switch 8 is now on; if it is not, writes will be done, crashing the disk. The 501 and 502 Reliability will behave in the following manner:

#### A. RANDOM RELIABILITY TEST (SA 501) WITH OPTIONS

THE OPERATOR IS GIVEN OPTIONS ON DATA PATTERNS (FROM THE COMMAND STRING DATA) AND MAY CHOOSE A CONSTANT CYLINDER, HEAD, SECTOR OR # OF SECTORS. ANY LETTER RESPONSE TO CYL, HEAD ETC. GETS RANDOM FUNCTION FOR THAT VARIABLE. A CARRIAGE RETURN ONLY GETS THE RANDOM FUNCTION FOR ALL VARIABLES.

THE OPERATOR IS ALSO ASKED TO RESPOND TO JITTER OPTION (YES/NO). IF YES, A RANDOM DELAY (0-40,50MS) IS INSERTED INTO THE BACKGROUND LOOP TO CREATE A MORE ASYNCHRONOUS DISK I/O LOOP.

#### B. SEQUENTIAL DISK ADDRESS TEST (SA 502)

THE OPERATOR IS GIVEN OPTION ON DATA (FROM THE COMMAND STRING DATA). REQUESTED DATA IS FIRST WRITTEN OVER THE ENTIRE PACK. THEN THE DATA IS READ FROM ALL SECTORS. THIS ENSURES THAT ALL DISK PACK BLOCKS ARE USABLE AND ARE FORMATTED PROPERLY. THE TEST IS THEN REPEATED FOR ALL READY DISKS; AND PASS IS PRINTED. THE SEQUENCE IS REPEATED INDEFINITELY.

### 3.4 CUSTOMER SUPPORT HOTLINE

ZETACO, Inc. provides a Customer Support Hotline (612-941-9480) to answer technical questions and to assist with installation and trouble-shooting problems.

The Hotline is manned by a technical team from 8:00 a.m. to 5:00 p.m. (Central Time) Monday through Friday.

Please review the General Installation Checklist before calling the Hotline.

### 3.5 WARRANTY INFORMATION

All ZETACO controllers and couplers are warranted free from manufacturing and material defects when used in a normal and proper manner for a period of up to two years from date of shipment. Except for the express warranties, stated above, ZETACO disclaims all warranties, including all implied warranties of merchantability and fitness. The stated express warranties are in lieu of all obligations of liabilities on the part of ZETACO for damages, including but not limited to, special, indirect or consequential damages arising out of or in connection with the use or performance of ZETACO's products.

### 3.6 PRODUCT RETURN AUTHORIZATION

When a controller malfunction has been confirmed using the tests outlined in Sections 3.1 to 3.3 above, the controller can be returned to the ZETACO Authorized Distributor from whom you bought the unit, or to ZETACO. A Return Material Authorization (RMA) number is required before shipment and should be referenced on all packaging and correspondence.

To ensure prompt response, the information outlined in the Material Return Information form on the following page should be gathered before calling your Distributor or the ZETACO Hotline for the RMA number. Please include a completed copy of the Material Return Information form with the product. Each product to be returned requires a separate RMA number and Material Return Information form.

To safeguard the controller during shipment, please use packaging that is adequate to protect it from damage (the original packing is best). Mark the box "Delicate Instrument" and indicate the RMA number(s) on the shipping label.



GENERAL INSTALLATION CHECKLIST

CPU \_\_\_\_\_ Operating System and Rev. \_\_\_\_\_

Is board replacing a previously installed subsystem? \_\_\_\_\_

Device Code of New Product: \_\_\_\_\_ Any similar subsystem in the

CPU? YES NO If yes, then its Device Code: \_\_\_\_\_

Configuration Facts \_\_\_\_\_

Problem Description \_\_\_\_\_

Problem happens where (during Dump, Reliability, etc.)? \_\_\_\_\_

Intermittent or consistent problem? \_\_\_\_\_

Does Self-test pass? \_\_\_\_\_

Priority of Board in CPU (Slot) \_\_\_\_\_

BMC Priorities of other BMC Devices (BMC Products Only) \_\_\_\_\_

Reviewed Interrupt and Priority Jumpers on Vacant Slots? \_\_\_\_\_

Tried Different Slot? \_\_\_\_\_

Cleaned gold-fingered contact points of board and reset board? \_\_\_\_\_

Supplied ZETACO 1/2" Tape "Boot" correctly? \_\_\_\_\_

Is peripheral set to correct unit number, and is terminator in? \_\_\_\_\_

For peripheral disk drives, what is Sector Switch setting? \_\_\_\_\_

Double checked PIN 1 of cable to Pin 1 of controller, backplane  
and peripheral? \_\_\_\_\_

Result of ZETACO Reliability or Diagnostics: \_\_\_\_\_



# MATERIAL RETURN INFORMATION

All possible effort to test a suspected malfunctioning controller should be made before returning the controller to ZETACO for repair. This will: 1) Determine if the board is actually defective; 2) Increase the speed and accuracy of a product's repair, which is often dependent upon a complete understanding of the user's checkout test results, problem characteristics, and the user system configuration. Test results for the BMX-3 Controller should be obtained by performing the tests below. (Include error program counter numbers and accumulator contents if applicable). Use back of sheet if more space is needed.

FUNCTION	TEST	RESULT
Power-up	Self-test	_____
Controller	Diagnostics	_____
Sub-system	Reliability	_____

Other tests performed (system operation, errors, etc.):

Please allow our service department to do the best job possible by answering the following questions thoroughly and returning this information with the malfunctioning board.

1. Does the problem appear to be intermittent or heat sensitive? (If yes, explain).
2. Under which operating system are you running? (AOS, RDOS, AOS/VS, ERDOS). Include revision number.
3. Describe the system configuration (i.e. peripherals, I/O controllers, model of computer, etc.).

To be filled out by CUSTOMER:

Model #: \_\_\_\_\_  
Serial #: \_\_\_\_\_  
RMA #: \_\_\_\_\_ (Call ZETACO to obtain an RMA number).

Returned by:

Your name: \_\_\_\_\_  
Firm: \_\_\_\_\_  
Address: \_\_\_\_\_  
Phone: \_\_\_\_\_



## 4.0 CONTROLLER USAGE GUIDELINES

### 4.1 CONTROLLER FEATURES PROGRAMMED BY THE CONFIGURATOR

#### 4.1.1 CONFIGURATOR AID (HELP)

The BMX-3 Configurator Program includes two "HELP" commands: one for OPERATIONAL questions and one that suggests WHAT you might want to do. In addition, you can get an explanation for any item by responding with an "H" to the question. Please use these functions whenever you are uncertain as to what to do.

#### 4.1.2 THROTTLE BURST RATE

This is defined as the number of word transfers that take place over the DCH or BMC during a single bus access by the disk controller. Throttle adjustment is dependent upon the type of system configuration in which the controller is installed. Too low a throttle setting could result in slow disk performance and too high a setting could cause a data late on another DCH or BMC device. The controller may be set to burst rates of 4, 8, 16, 32, 64; 128 and 256 words per access. A burst rate of 16 is recommended for most applications.

The BMX-3 allows you to select a different burst rate for each SMD port, thereby giving the ability to fine tune the bus to the particular speed or activity of each disk drive.

#### 4.1.3 SYNC BYTE

The BMX-3 supports a disk media format which contains a header sync byte and data field sync byte (versus a sync bit). The sync byte provides better header address verification and data integrity. This sync byte is user definable for each drive port. Any value between 01 hex and FF hex is acceptable, although 93 hex (223 octal) is the recommended value. When entering a sync byte, use the octal number. This feature can provide a means for disk pack access security between different disk subsystems.

#### 4.1.4 ERROR CORRECTION ENABLE/DISABLE

When this function is enabled, on-board error correction and data strobe early/late occur automatically on bad disk data. Also, a running count of ECC corrections and successful data strobe early or late data recoveries are logged in scratch pad memory, with a separate count for each unit. With this function disabled, ECC corrections must be handled by the software. This feature can be selected on any port.

If any disks are going to be formatted and initialized following configuration, it is recommended that on-board ECC be disabled, then re-enabled after disk initialization.

#### 4.1.5 INTERLEAVE FACTOR

The BMX-3 supports any sector interleave from 2:1 to 6:1 and each drive port can have a different interleave ratio. 1:1 interleave (non-interleave) is recommended for optimum performance and should be sufficient in most cases. Disk drives with very high transfer rates may require a sector interleave of 2:1 to avoid missing the next logical sector.

Interleaving may be used, along with throttling, to fine tune a system's performance. This is to avoid going a full revolution on the disk when the CPU cannot respond fast enough to access the next consecutive sector.

If DCH or BMC activity is too high to access the next consecutive sector, indicated by extremely slow disk performance, then an interleave factor of 2:1 or greater should be selected. To maintain optimum performance, don't select an interleave greater than is required to access the next logical sector in a multiple sector transfer.

#### 4.1.6 DISK DRIVE TYPES

The BMX-3 is capable of controlling virtually any disk drive that meets the SMD interface specification, including HSMD and ESMD. The controller may be configured to assign drives of varying capacities, transfer rates, formats, etc. to any of the four ports.

When running under AOS, only those drives that meet the sizing characteristics of the supported emulations can be used. Under RDOS the BMX-3 can take advantage of the full capacity of most disk drives because ZETACO's disk initializer, CSDKINIT, allows deviation from standard RDOS disk emulations.

This section of the Configurator Program allows the operator to assign drive characteristics on a port-by-port basis. Note that drive characteristics are assigned per "port", or "B" cable, and not per the drive's unit number setting. (Any unit can be connected to any of the four ports). A warning will be issued when a potentially illegal configuration is attempted. "HELP" information is available throughout.

Notes regarding dual volume drives:

Dual volume drives must be assigned an even unit number. A dual volume drive is treated as two logical units, so a maximum of two dual volume drives or one dual volume and two single volume drives may be attached to the controller.

There are two forms of dual volume drives:

The first is an actual dual volume drive, designed with two physical volumes, usually one fixed and one removable cartridge. These include the Control Data Corporation Lark and 9448 (CMD), and Amcodyne's 7110.

The other form is actually a single volume drive which is "split" by the controller into two logical units to provide the sizing characteristics necessary for emulation. For example, under AOS the Fujitsu 2351 (Eagle) is split for dual 6061 emulation, and the Fujitsu 2333 is split for dual 6161 emulation.

Both forms of dual volume drives must have each logical unit formatted separately by the initializer programs (CSDKINIT for RDOS or DFMTR for AOS). In the case of ZETACO'S formatter program, which must be run prior to the initializer program, the "split" form of dual volume drives must be formatted at the same time or errors will occur. True dual volume disk drive may be formatted at the same time or separately.

#### 4.2 DISK ECC COUNTER UTILITIES

The Model BMX-3 Controller maintains a counter of ECC corrections for each disk drive connected to the controller(s). These are the corrections performed by the firmware and are therefore invisible to the system except through these counters. The counters are automatically cleared by the reset switch on the computer front panel or if the controller is powered down.

The utilities must be loaded onto disk from the Software Support Package tape (RDOSECC.SV for RDOS and AOSECC.PR for AOS), and allow you to monitor the media by displaying or modifying the counters. You may want to reset the counters to zero on some regular basis: daily, weekly, monthly, etc.

STEP 1 - EXECUTING THE PROGRAM UNDER CLI

- A) RDOS Version  
ENTER: RDOSECC
- B) AOS Version  
ENTER: X AOSECC

STEP 2 - MAIN MENU

ZETACO - ECC FUNCTIONS

- 1 - DISPLAY CONTROLLER ECC CORRECTIONS
- 2 - RESET CONTROLLER ECC CORRECTIONS
- 3 - STOP

NOTE - SELECT ONLY THOSE DRIVES WITH ZETACO CONTROLLERS.  
RESULTS ARE UNPREDICTABLE ON OTHER BOARDS!

ENTER SELECTION

YOU RESPOND:

- 1) To display the ECC corrections counter(s)
- 2) To modify the ECC corrections counter(s)
- 3) To terminate the program and return to the CLI

STEP 3 - ENTERING THE UNIT

If you selected 1 or 2,

PROGRAM DISPLAYS:

ENTER UNIT:

YOU RESPOND:

DZn (n=0, 1, ..., 7) for RDOS  
DPFN (n=0, 1, 2, 3, 10, 11, 12, 13) for AOS  
Carriage return or new line to return to Main Menu.

The program will display the (decimal) value of the corrections counter for the drive selected. This step will be repeated until the response to ENTER UNIT is Carriage Return or New Line.

STEP 4 - MODIFYING THE COUNTER

If your response to the Main Menu was 2 - there will be another message after Step 3:

ENTER NEW VALUE:

You respond with the (decimal) value to which you want the counter set. The number must be between 0 and 65, 535. This step will be repeated until you enter a Carriage Return or New Line, which will return you to Step 3.



## 5.0 PROGRAMMING NOTES

This section discusses, in detail, the assembly level programming characteristics of the D.G. system in relation to this disk controller. This is of most use to technicians involved in component level diagnostic testing and to programmers involved with utility writing.

### 5.1 INSTRUCTION FORMAT

Symbolic form for I/O instructions:

DXXF AC, DSKP

DXX - DOA, DOB, DOC, DIA, DIB, DIC

F = Function:

- C (Clear) - Resets Busy and Done flags to zero, aborts all data transfer commands, and clears data transfer status (DIA) fault bits 6, 7, 8, 9, 10, 11, 12, 13, 14 & 15. Also clears RD/WRT and drive attention flags and Interrupt request.
- S (Start) - Sets busy flag, clears done and initiates one of the following commands selected by a DOA: Read, Write, Format, Read Buffers or Verify. Also clears interrupt request and data transfer status (DIA) fault bits 6, 7, 8, 9, 10, 11, 12, 13, 14 & 15.
- P (Pulse) - Sets control full flag and initiates one of the following commands selected by a DOA: Recal, Seek, Stop, Offset, Write Disable, Release, Trespass and Exam Controller RAM.

AC = Accumulator: 0, 1, 2 or 3.

DSKP = Device Code: Primary - 27 Octal

Secondary - 67 Octal

(Others available)

## BINARY REPRESENTATION OF AN I/O INSTRUCTION

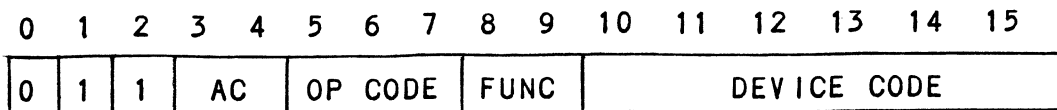

INTERRUPT MASK      BIT 7

MSKO AC

Execution of the Mask Instruction with BIT 7 equal to a one in the selected accumulator will set the interrupt mask within the controller. This will inhibit any further interrupt requests by the controller until the interrupt mask is cleared, either by an IORST instruction or execution of the Mask Instruction with accumulator BIT 7 equal to a zero.

IORESET INSTRUCTION

IORST

Execution of an IORST instruction serves as a master reset to the controller. Upon completion of an IORST the controller will attempt to select unit zero and default the command register to a read operation. The controller ECC correction LOG is not cleared out by this instruction.

IOSKIP INSTRUCTION

Used to poll the state of the controller (command is done or busy). If the skip condition is met, the next instruction is skipped; otherwise the next instruction is executed.

SKPBZ DSKP - SKIP IF BUSY FLIP-FLOP IS CLEAR.  
SKPBN DSKP - SKIP IF BUSY FLIP-FLOP IS SET.  
SKPDZ DSKP - SKIP IF DONE FLIP-FLOP IS CLEAR.  
SKPDN DSKP - SKIP IF DONE FLIP-FLOP IS SET.

5.2 ACCUMULATOR FORMATS

5.2.1 DOA - SPECIFY COMMAND AND DRIVE

DOAF AC, DSKP

0	1	2	3	4	5	6	7	8	9	10	11	12	13	14	15
0	1	1	AC	0	1	0	F	DEVICE CODE							

Accumulator

0	1	2	3	4	5	6	7	8	9	10	11	12	13	14	15
R/W DN	CLR SEEK DONE		COMMAND				DRIVE		EMA MSB's						

BIT POSITION

- 0 - Clear Read/Write Done if it is a one
- 1 - Clear Seek Done Attention Flag for Drive Unit 0 if it is a ONE
- 2 - Clear Seek Done Attention Flag for Drive Unit 1 if it is a ONE
- 3 - Clear Seek Done Attention Flag for Drive Unit 2 if it is a ONE
- 4 - Clear Seek Done Attention Flag for Drive Unit 3 if it is a ONE
- 5 - 8 Specify Command

		FUNCTION REQUIRED TO INITIATE
0000	READ	START
0001	RECALIBRATE	PULSE
0010	SEEK	PULSE
0011	STOP DISC	PULSE
0100	OFFSET FORWARD	PULSE
0101	OFFSET REVERSE	PULSE
0110	WRITE DISABLE	PULSE
0111	RELEASE DRIVE	PULSE
1000	TRESPASS	PULSE
1001	SET ALT MODE 1	NONE
1010	SET ALT MODE 2	NONE
1011	EXAMINE RAM	PULSE
1100	DATA VERIFY	START
1101	READ BUFFERS	START
1110	WRITE	START
1111	FORMAT	START

NOTE: See Section 5.3 for detailed command description.

9 - 10 Drive Selection

- 00 - Drive Unit 0
- 01 - Drive Unit 1
- 10 - Drive Unit 2
- 11 - Drive Unit 3

DOA will reserve a previously unreserved drive

BIT Position 9 is not used if 616X

11-15 Extended Memory Address

Specifies the MSB's of the Extended Memory Address

5.2.2 DOB - LOAD STARTING MEMORY ADDRESS

DOBF AC, DSKP

0	1	2	3	4	5	6	7	8	9	10	11	12	13	14	15
0	1	1	AC	1	0	0	F	DEVICE CODE							

Accumulator

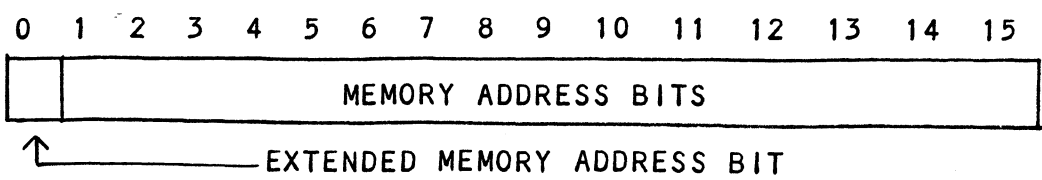

Execution of this instruction will load the controllers address counter with the contents of the specified accumulator and will be used as the starting memory address for a command that requires a DCH transfer or a BMC transfer operation.

5.2.3 DOC - LOAD DRIVE ADDRESS

5.2.3.1 DOC - SPECIFY CYLINDER

DOCF AC, DSKP

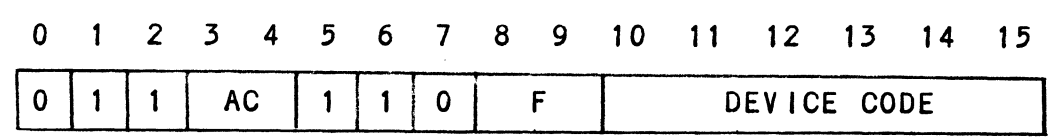

Accumulator (if previous DOA specified a Seek)

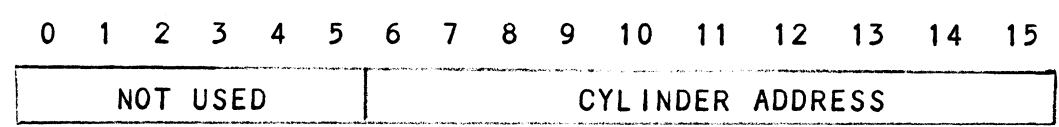

5.2.3.2 DOC - FIRST DOC SPECIFIES EXTENDED SURFACE, SECTOR AND COUNT (Double DOC mode only)

Accumulator (if previous DOA specified a Read, Write, Format or Data Verify)

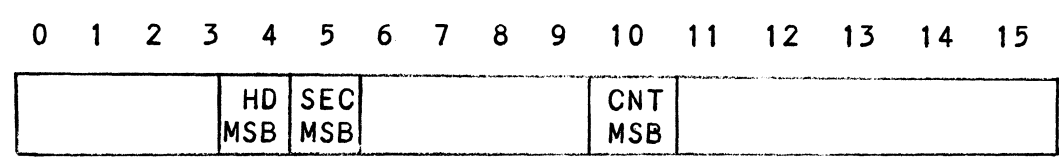

5.2.3.3 DOC - SECOND DOC SPECIFIES LOWER FIVE BITS OF SURFACE, SECTOR AND COUNT (First and only DOC if single DOC mode)

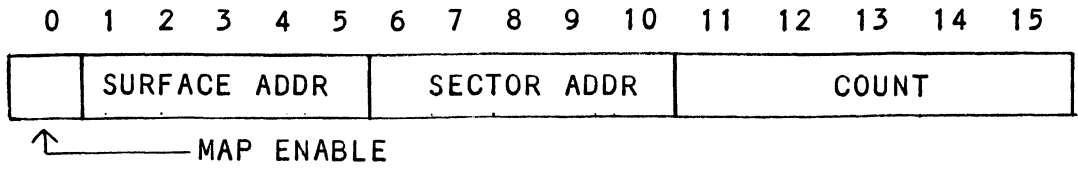

- 0 - Enable BMC Address Mapping
- 1 - 5 Starting Surface Address
- 6 - 10 Starting Sector Address
- 11-15 Two's complement of number of sectors to be transferred

5.2.4 READ STATUS - NON ALTERNATE MODE

5.2.4.1 DIA - READ DATA TRANSFER STATUS

DIAF, AC, DSKP

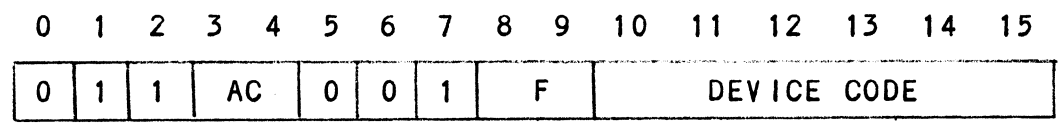

Accumulator

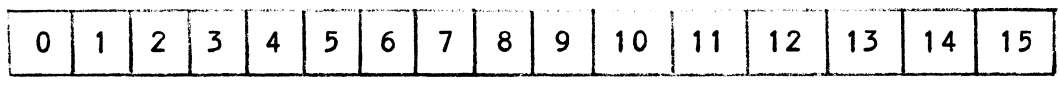

- 0 - Control Full
- 1 - R/W Done
- 2 - Unit 0 Atten Done
- 3 - Unit 1 Atten Done
- \*4 - Unit 2 Atten Done
- \*5 - Unit 3 Atten Done
- 6 - BMC Bus Parity Error
- 7 - Illegal Sector Adr
- 8 - ECC Error
- 9 - Bad Sector Flag
- 10 - Cyl Addr Error
- 11 - Surf/Sect Addr Error
- 12 - Verify Error
- 13 - R/W Timeout
- 14 - Data Late
- 15 - Read/Write Fault

\*BIT Positions 4 and 5 are not defined if 616X Emulation.

0	CONTROL FULL	Will be a one when the controller receives a pulse function. Will be a zero once the controller completes the function to the drive that was specified by the command (Recal, Seek, Stop Disk, Offset, WRT DIS, Release, Trespass and Exam Ram).
1	R/W DONE	A one indicates that the done flag was set following a data transfer command.
2-5	UNIT ATTEN DONE (UNITS 0-3)	A one indicates that the respective drive completed a successful seek or recalibrate operation. If the drive was unsuccessful in its attempt to seek, a positioner fault status will be indicated. A recalibrate operation will clear the fault.
6	BUS PARITY ERROR	Indicates an Address or Data Parity Error occurred on a Data Transfer between the controller and the BMC
7	ILLEGAL SECTOR ADDR	Indicates the starting sector address (DOC) exceeded the capacity of the drive if set to a one. Done sets immediately.
8	ECC ERROR	A sector of data read from the disk did not correlate with the appended polynomial. This means that the data read does not agree with the data that was originally written.
9	BAD SECTOR FLAG	Indicates the controller detected the bad sector flag set to a one within the sectors address header. (Done will set immediately). This implies that the format program originally determined that the surface within this sector could not support error-free data.

10	CYLINDER ADDRESS ERROR	The Cylinder Address contained within the sector's header did not match the requested cylinder given by the previous seek command. Bit 11 will set, instead, if there is no match due to a media flaw. The Read/Write Operation will be terminated immediately.
11	SURFACE/ SECTOR ADDRESS ERROR	<p>This status bit may be set by one of the following cases:</p> <p>1) The Surface or the Sector Address contained within the sector's header did not match the current contents of the controller's Surface/Sector Register (Initiated by a DOC).</p> <p>2) The CRC polynomial did not correlate with the Header Address.</p> <p>3) The Data Sync on a Read Command could not be detected. The Read/Write operation will be terminated immediately.</p>
12	VERIFY ERROR	Data in memory did not agree with the data on the disk. (See Verify Command).
13	READ/WRITE TIMEOUT	A Read or Write type of operation did not complete within one second.
14	DATA LATE	Not implemented.
15	READ/WRITE FAULT FLAG	A one indicates that at least one bit is set in bit positions 6 through 14 or a drive fault occurred during a Read/Write transfer operation.

Refer to Table 5.1 for detailed description.



TABLE 5.1 Read/Write Faults (DIA)

	STATUS BIT POSITION	CONTROLLER ACTION	ERROR RECOVERY
BUS ERROR	6	Sets done immediately if Address error. Sets done at the end of sector transfer if data error.	New command. Re-try Read/Write Transfer. Insure BMC Bus Terminators are installed. If a second BMC device is connected, make sure it has a different Bus Priority.
ILLEGAL SECTOR ADDRESS	7	Sets done immediately.	New command if error re-occurs. Make sure the controller is configured to match the drive type.
ECC ERROR	8	Sets done at the end of sector transfer.	New command. Re-tries with servo offset may correct the data. If this error is detected on a surface analysis, the bad sector flag should be set.
BAD SECTOR FLAG	9	Sets done immediately.	New command. This sector should be ignored.
CYLINDER ADDRESS ERROR	10	Sets done immediately.	New command. The system should diagnose this as a positioner fault.
SURF/ SECTOR ADDRESS ERROR	11	Sets done immediately.	New command. Bad sector flag should be set if surface analysis.
VERIFY ERROR	12	Sets done at the end of the sector transfer.	New command. Check ECC error also to determine if the error occurred due to a flaw in the media.
READ/ WRITE TIMEOUT	13	Sets done immediately.	New command.

## 5.2.4.2 DIB - READ DRIVE STATUS

DIB AC, DSKP

0 1 2 3 4 5 6 7 8 9 10 11 12 13 14 15

0	1	1	AC	0	1	1	F	DEVICE CODE							
---	---	---	----	---	---	---	---	-------------	--	--	--	--	--	--	--

Accumulator

0	1	2	3	4	5	6	7	8	9	10	11	12	13	14	15
---	---	---	---	---	---	---	---	---	---	----	----	----	----	----	----

- \*0 - Invalid Status
- \*1 - Drive Reserved
- \*2 - Trespassed
- \*3 - Ready
- \*4 - Busy
- \*5 - Positioner Offset
- \*6 - Write Disabled
- \*7 - ID
- \*8 - III Sur/Cyl Addr
- \*9 - Illegal Command
- \*10 - DC Voltage Fault
- \*11 - Pack Unsafe
- \*12 - Positioner Fault
- \*13 - Servo Clock Fault
- \*14 - Write Fault
- \*15 - Drive Fault

\*These Bits are undefined if 616X.

- 0        INVALID STATUS    A one indicates that Status Bits 1 through 15 should be ignored because the drive is not selected or it is in the process of being selected.
- 1        DRIVE RESERVED    In a dual port configuration the selected drive is currently in use by another processor.

2	TRESPASSED	Not implemented.
3	READY	Drive unit specified by a previous DOA command is selected, spindle is up to speed and positioner is on cylinder.
4	BUSY	The positioner within the currently selected drive is not on cylinder.
5	POSITIONER OFFSET	The selected Read/Write head was moved from on cylinder dead center as was specified by an offset forward or reverse command.
6	WRITE DISABLED	Status from the drive indicates that a write type of command cannot be executed.
7	ID	This Bit is a one if 6122 is selected, a zero for all other emulations.
8	ILLEGAL SURFACE OR CYLINDER ADDRESS	The requested surface or cylinder address exceeds the capacity of the drive. Read/Write operation will terminate immediately.
9	ILLEGAL COMMAND	The controller was requested to perform a write type of command while servo is offset or write disabled is active.
10	DC VOLTAGE FAULT	Not implemented.
11	PACK UNSAFE	Conditions exist within the drive that may impair the safety of the media. This bit will be a one if a fault status is received directly from the drive interface.

- 12            POSITIONER  
              FAULT            This indicates that the drive was unable to complete a seek within 500 ms, or that the positioner has moved to a position outside the recording field. The system should send a recal command to recover from this error.
- 13            SERVO CLOCK  
              FAULT            A clock synchronization failure occurred between the serial data being read and the reference clock coming from the disk drive.
- In most cases this means that the header or data sync was not encountered within a specified amount of time.
- This flag would set if the format on the disk did not agree with what the controller expected.
- Check the configuration to make sure the proper format was selected.
- 14            WRITE FAULT            An abnormal condition was detected by the drive during a data transfer operation.
- 15            DRIVE FAULT            One or more bits are set in positions 8 through 14 or the drive detected an abnormal condition.

5.2.4.3 DIC - READ SURFACE, SECTOR AND COUNT

DICF AC, DSKP

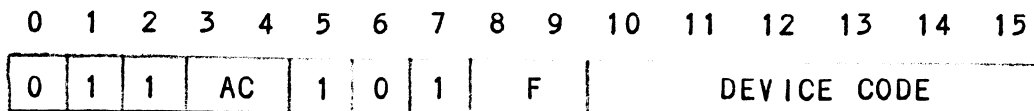

Accumulator

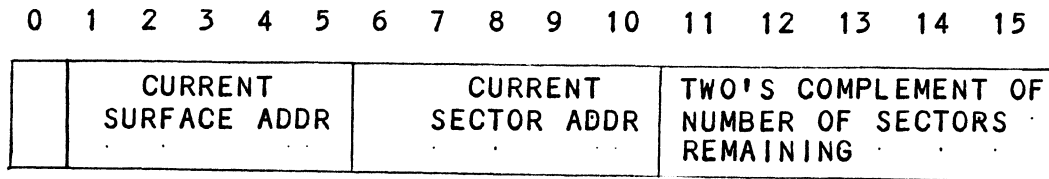

↑ MAP ENABLED

5.2.5 READ STATUS - ALTERNATE MODE ONE

See detailed description of Alternate Mode One Command. Previous DOA specified ALT Mode One for Sections 5.2.5.1 through 5.2.5.3.

5.2.5.1 DIA - READ CURRENT MEMORY ADDRESS

DI AF AC, DSKP

Accumulator

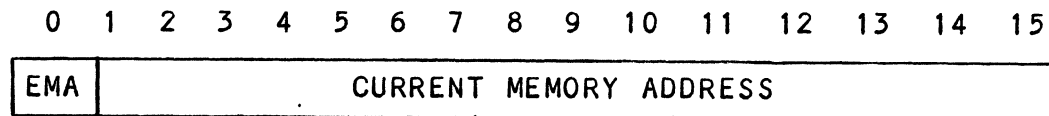

After the execution of this instruction the value of the accumulator will contain the memory address to where the next data word transfer will take place. The memory address counter is incremented by one after each DCH or BMC transfer.

### 5.2.5.2 DIB - READ EXTENDED MEMORY ADDRESS

DIBF AC, DSKP

Accumulator

0	1	2	3	4	5	6	7	8	9	10	11	12	13	14	15
---	---	---	---	---	---	---	---	---	---	----	----	----	----	----	----

- 0 - BMC Mode
- 1 - Fixed Disk
- 2 - Drive 0 ID
- 3 - Drive 1 ID
- 4 - Surface Address (MSB)
- 5 - Sector Address (MSB)
- 6 - Drive 0 ID
- 7 - Drive 1 ID
- 8 - Not Used
- 9 - Not Used
- 10 - Sector Count (MSB)
- 11-15 - Extended Memory Address

The AC will contain the current most Significant Bits for the Surface (BIT 4), Sector Address (BIT 5) and Two's Complement Count (BIT 10). These Bits will allow the System to reference up to 64 heads or sectors.

### 5.2.5.3 DIC - NOT CURRENTLY IMPLEMENTED

### 5.2.6 READ STATUS - ALTERNATE MODE TWO

See detailed description of Alternate Mode Two Command. Previous DOA specified ALT Mode Two for Sections 5.2.6.1 through 5.2.6.3.

### 5.2.6.1 DIA - READ ECC REMAINDER UPPER

DIAF AC, DSKP

Accumulator

0	1	2	3	4	5	6	7	8	9	10	11	12	13	14	15
31	30	29	28	27	26	25	24	23	22	21	20	19	18	17	16
X	X	X	X	X	X	X	X	X	X	X	X	X	X	X	X

### 5.2.6.2 DIB - READ ECC REMAINDER LOWER

DIBF AC, DSKP

Accumulator

0	1	2	3	4	5	6	7	8	9	10	11	12	13	14	15
15	14	13	12	11	10	9	8	7	6	5	4	3	2	1	0
X	X	X	X	X	X	X	X	X	X	X	X	X	X	X	X

### 5.2.6.3 DIC - NOT CURRENTLY IMPLEMENTED

## 5.3 DETAILED COMMAND DESCRIPTIONS

The command set (16 in all) provided by the controller is basically broken up into three groups:

1. Data Transfer Command
2. Drive Commands
3. Alternate Mode Commands

The command is stored in the controller via a DOA instruction. Before any command is initiated, the selected unit must have valid status and be ready.

### 5.3.1 DATA TRANSFER COMMANDS

Start (Set Busy) will initiate any one of the following commands: Read, Write, Format, Verify or Read Buffers. Up to 64 contiguous sectors may be transferred.

Read/Write Initialization Steps:

1. Control Full and Drive Status must be tested for proper state before commencing with a Read/Write Command.
2. Send the Starting Surface and Sector Address along with the Two's Complement of the number of sectors transferred. (See DOC)
3. Send the Starting Memory Address of where the data should be stored or retrieved. (See DOB)
4. Send the Command type and the desired Drive Unit Number. (See DOA)
5. Issue a Start Pulse.

### Read/Write Termination Possibilities (Done Set):

1. All the sectors implied by the Two's Complement sector count were transferred.
2. A Drive or Read/Write Error was encountered. DIC command should be issued to determine which sector the error occurred at.
3. Busy was cleared by an IORESET instruction or a clear pulse was issued to the controller during the Read/Write transfer. Done will not set in this case.

#### 5.3.1.1 READ COMMAND

When BUSY F/F sets, the controller will wait for ON CYLINDER if the previous seek command has not been completed yet. It will then search for the starting sector address specified by the previous DOC instruction. The header is read and compared with the starting sector address, the starting surface address and the stored cylinder address to ensure that the proper sector has been physically located. Before the data can be accepted, the header must match the specified address, the header CRC must be good, and no bad sector flags encountered.

If the header is in error or the bad sector flag is a one, the appropriate status bit and done flag are set immediately.

When the drives RD/WRT head reaches the data field, the serial data is sent to the SMD interface formed into parallel words by the controller and transferred to the buffer. When all 256 words are contained within the buffer, the ECC Code appended in the data is checked to ensure proper data by reading the results of the remainder. A data error occurred if the remainder is not equal to zero.

In the case of an error the controller will transfer the data into memory and then set ECC Error Flag and Done. If the ECC Enable feature is selected (refer to Configuring Section), the controller will attempt to correct the data within its own buffer prior to transferring it to memory.

If it determines that the error is not correctable, the controller will re-try on its own with a Data Strobe Early and if unsuccessful, again with a Data Strobe Late. If the data is still not correctable, then it will set ECC Error Flag and Done. If more sectors are to be transferred, the controller will begin searching for the next sector while the data from the previous sector is transferred to memory.



### 5.3.1.2 WRITE COMMAND

When BUSY sets, the controller will wait for the positioner to be On Cylinder if the selected drive is still in the process of seeking. Upon the completion of the previous seek operation, the controller will transfer 256 words of data from memory to a sector buffer. The starting address of memory was specified by the previous DOB instruction. The controller searches for the desired sector and performs a head verification (same as the read command) before data is written onto the surface of the disk.

Once the correct sector is found, the controller will select the sector buffer previously written by the DCH control. The contents of this buffer is then written on to the disk surface, preceded by a gap and data sync.

The controller incorporates two sector buffers. Therefore, the BMC or DCH logic can write into one buffer while data is transferred to the disk from the other. The Ping-Pong method of buffering help avoid the data under/overflows common with traditional FIFO buffers.

### 5.3.1.3 VERIFY

When BUSY F/F sets, the controller starts as if it had a Read command (i.e. wait for On Cylinder, verify header etc). Once a full sector is transferred from the disk to a controller buffer, a comparison is made against system memory. This is accomplished by reading a word from memory starting from the previous DOB and comparing each word of sector. If a word does not compare, data transfer status (DIA) Bit 12 and Done will set.

### 5.3.1.4 FORMAT

The objective of the Format command is to write the header information (surface, sector and cylinder address) on a sector. Up to 64 contiguous sectors may be formatted per command. Data that was contained within the sector will be lost (replaced by all zeros). Refer to Appendix C for format details. The Format command is also used to set the bad sector flag.

### 5.3.1.5 READ BUFFERS

This command reads the contents of the currently used buffer and transfers all 256 words to memory specified by the starting address. Primarily used for diagnostic purposes.

### 5.3.2 DRIVE COMMANDS

IOPULSE (sets control full) initiates any one of the following commands: Recalibrate, Seek, Stop, Offset, Write Disable, Release, Examine Ram and Trespass.

#### 5.3.2.1 RECALIBRATE

This command moves the heads to cylinder 0, selects Head 0, and issues a fault clear to the drive.

An IORESET switch will automatically cause a Recalibrate command to be issued to Unit 0.

This command moves the heads more slowly than a seek to 0, so it should not be used for data acquisition.

#### 5.3.2.2 SEEK

Seek moves the heads to the cylinder specified by the DOC. The controller stores the cylinder address for that particular unit, initiates the SEEK operation and clears control full. While that unit is busy seeking the controller can accept another SEEK command for a different unit (overlapped seeks), or commence with a Read/Write Command for the unit busy seeking.

See the disk drive specification for the Seek Timing.

#### 5.3.2.3 OFFSET FORWARD

"OFFSET FORWARD" offsets the heads forward off the track center-line. This operation is cleared by the next command. (The drive does not allow write operations when the positioner is Offset).

#### 5.3.2.4 OFFSET REVERSE

"OFFSET REVERSE" offsets the heads reverse off the track center-line. This operation is cleared by the next command. (The drive does not allow write operations when the positioner is Offset.) Offset forward or reverse may be used as an attempt to recover data that cannot be corrected by the error correction algorithm.

#### 5.3.2.5 WRITE DISABLE

Not implemented.

#### 5.3.2.6 RELEASE DRIVE

Clears the reserved condition of the specified drive that the computer had previously reserved.

#### 5.3.2.7 TRESPASS

The controller issues a priority select to the specified drive. The drive will immediately be reserved until a release command is issued or the drive timeout feature times out.

#### 5.3.2.8 STOP DISK

All drives connected that are selected for remote operation will unload the heads and spin down via the pick-hold line. A console reset, IORESET instruction, or another command will spin the disk back up.

#### 5.3.2.9 EXAMINE RAM COMMAND

This command gives the system the capability of reading from or writing to the BMX-3 controller's memory. This command must be preceded by a DOC containing the address of the desired RAM location. See Appendix B for memory map.

In order to write to RAM, Bit 0 (MSB) must be a one in the DOC address, and the data to be written is sent via the DOB. If a read RAM is implied (DOC Bit 0 = 0), the contents of the DIC will contain the RAM data after Control Full clears.

This feature is used for obtaining the following information:

- A. Drive characteristics for the Formatter and Reliability programs.
- B. Number of ECC corrections by the controller. (Each unit has a separate count.)
- C. Maintenance testing.
- D. Configuring the EEPROM.
- E. Features that may be considered in the future.

1460-1462      SELECTED  
DRIVE  
CHARACTERISTICS      These locations will be updated whenever a new drive is selected.

- 1460 - Maximum sector address
- 1461 - Maximum surface address
- 1462 - Maximum cylinder address

Allow invalid status to go away before a reference is made. Avoid writing to these locations.

1500-1503      UNIT  
CORRECTION  
COUNTS      These locations will be incremented each time the controller does a correction either by the ECC algorithm or an Early/Late re-try. The maximum count per unit is 65535 (the count will stay at maximum if there are any more corrections to that unit). The counts are initialized to zero on either a power on or an IORESET switch.

A separate count is maintained for each unit.

- 1500 - Unit 0
- 1501 - Unit 1
- 1502 - Unit 2
- 1503 - Unit 3

EXAMINE RAM COMMAND

1777-8 PROM ID/REV

DIC ACCUMULATOR

0	1	2	3	4	5	6	7	8	9	10	11	12	13	14	15	
0	R E S	IDENTIFICATION						REVISION LEVEL								

EXAMPLE: Identification 80 (Hex) Revision Level 6

Location 1777-8 = 100006

NOTE: Avoid referencing any locations that are not defined here.

EXAM RAM EXAMPLE

READ Contents of Loc 1500 Octal (Unit 0 corrections)

Accumulator Set up:

A0 = 002600 (NOP Command Unit 0)  
A1 = 001500 (RAM Address for DOC)

DOC 1, DSKP ; Send RAM Address  
DOAP 0, DSKP ; Send NOP Command and IOPULSE  
DIA 0, DSKP ; Wait for Control Full  
MOVZL# 0,0,SZC ; To be zero  
JMP .-2

DIC 2, DSKP ; Put contents of RAM Location  
1500 into Accumulator 2

WRITE To Location 1500 Octal (Clear Unit 0 Corrections)

Accumulator set up:

A0 = 002600 (NOP Command Unit 0)  
A1 = 101500 (RAM Address for DOC)  
A2 = 000000 (RAM Data)

DOC 1, DSKP ; Send RAM Address  
DOB 2, DSKP ; Send RAM Data  
DOAP 0, DSKP ; Send NOP Command and IOPULSE

### 5.3.3 ALTERNATE MODES

A command that will change the context of the data received from a DIA, DIB or DIC. A command other than Alternate Mode or an IORESET will clear Alternate Mode.

#### 5.3.3.1 ALTERNATE MODE ONE

It changes the context of DIA to read the current memory address. The ending address after a Read/Write transfer will point to the last address plus one.

#### 5.3.3.2 ALTERNATE MODE TWO

It changes the context of the DIA and DIB command. This is used to extract the syndrome (ECC remainder not equal to zero after a read command) from the controller in order to determine whether the data error within the sector read is correctable or not.

### 5.4 ERROR CORRECTION CODE (ECC)

When a write command is specified, the ECC hardware divides the data field within the sector by a fixed \*generator polynomial and appends the resulting checkword to the data field.

\*Generator Polynomial

$$X^{-32} + X^{-23} + X^{-21} + X^{-11} + X^{-2} + 1$$

When a read command is specified, the ECC hardware divides the data field and the appended checkword within the sector by a \*factored version of the same generator polynomial. If a data error occurs, the resulting remainder is non-zero, and the data transfer status (DIA) bit position 8 is set. BIT 8 will not set if the controller was enabled to correct and the error is correctable.

Be aware that there exists a small class of errors that are undetectable due to the cyclic properties of the generator polynomial.

\*Factored Version of Generator Polynomial

$$(X^{-1} + X^{-2} + 1) (X^{-21} + 1)$$

The ECC feature detects all error bursts contained within 21 or less contiguous bits in a sector and allows correction of all error bursts up to 11 contiguous bits.

## 5.5    FORMAT SEQUENCER

The BMX-3 disk controller features a format sequencer that controls the disk interface functions of the controller. The firmware that controls this sequencer is contained in PROMS, allowing disk format changes to take place there instead of the microprocessor firmware.

The format sequencer firmware is arranged in eight banks of 64 words each and is selectable for the format bank desired. Each bank consists of READ/WRITE/FORMAT CODE. The last bank is reserved for Self-test.





## APPENDIX A

### A.0 DIAGNOSTIC BOOTSTRAP PROCEDURES

- 1) Load desired Software Support Package tape and put drive On-line.
- 2) Perform the following steps when the system has the program load option. (If system does not have program load option, consult processor manual.)
  - A) Put 100022 or 100062 on console data switches 0 - 15.
  - B) Program load.
    - a) Press program load switch if front panel has switches.
    - b) On D.G. virtual console, enter 100022L or 100062L (if 100062 first enter 100062 in 11A).
- 3) Enter tape file test number, followed by a carriage return.
- 4) If program is not self starting perform the following steps:
  - A) Front Panel Switches
    - a) Put starting address on console data switches (0-15).
    - b) Press examine memory.
    - c) Put switch settings on console data switches (0-15).
    - d) Press continue.
  - B) Virtual Console  
D.G.
    - a) Enter switch settings in 11A through keyboard.
    - b) Enter starting address (XXXXR) through keyboard.
    - c) To change switch settings, enter break, change 11A through keyboard, and enter PC address when break occurred. (XXXXR)
    - d) To continue on error halt, enter PC address (XXXXR).

### A.1 LOADING THE SOFTWARE SUPPORT PACKAGE ONTO DISK

1. Files 8, 9, and 10 on the Software Support Package Tape are RDOS, AOS and AOS/VS, respectively, dump formats of all the contained programs that can be loaded on the system disk.

EXAMPLES:   RDOS    - Load MT0:  8  
              AOS     - Load @MTA0: 9  
              AOS/VS - Load @MTC0: 10

2. The files can now be booted from disk. Enter the appropriate filename in response to "FILENAME?" or "SYSTEM PATHNAME?"



## APPENDIX B

### B.0 MEMORY MAPS

#### B.1 BMX-3 MICROPROCESSOR MEMORY MAP

ADDRESS (HEX)	NAME
000 - 0FF	SECTOR BUFFER 0
100 - 1FF	SECTOR BUFFER 1
200 - 2FF	SECTOR BUFFER 2
306	CYL 0
307	CYL 1
308	CYL 2
309	CYL 3
30A	CURRENT SURFACE, SECTOR, SECTOR COUNT
30B	EXT. DOC
30C	ZADJ. SURFACE ADDR
30D	SURF - SECT
310	BAD SECTOR FLAG
311	UNIT SELECT
312	SOFT ECC DISABLE (NOT USED)
320	UNIT 0 PORT SEEK END MAP
321	UNIT 1 PORT SEEK END MAP
322	UNIT 2 PORT SEEK END MAP
323	UNIT 3 PORT SEEK END MAP
330	ZADJ. MAX SECTOR
331	ZADJ. MAX SURFACE
332	ZADJ. MAX CYLINDER
333	SYNC BYTE
334	VOLUME ADDR (CMD)
335	BANK SEL, BMC PRIORITY
340	UNIT 0 CORRECTION COUNT
341	UNIT 1 CORRECTION COUNT
342	UNIT 2 CORRECTION COUNT
343	UNIT 3 CORRECTION COUNT
348	SECTOR VERIFICATION ENABLE
349	SECTOR COUNT
34A	LENGTH OF LAST SECTOR (COUNT *600 NANOSEC.)
3FF	PROM ID/REVISION LEVEL

B.2      EEPROM MAP

4800	START OF PORT 0
4880	START OF PORT 1
4900	START OF PORT 2
4980	START OF PORT 3
XX00	RCHAR SWITCHES
XX01	RPARA SWITCHES
XX02	DEVICE SELECT CODE
XX03	INTERLEAVE FACTOR
XX04	THROTTLE BURST RATE
XX05	BREAK COUNT
XX06	# OF BURSTS
XX20	MAX SECTOR
XX21	MAX CYL-UPPER
XX22	MAX CYL-LOWER
XX23	MAX HEAD
XX24	MAX HEAD-ODD UNIT
XX25	HEAD MASK
XX26	BANK,PRIORITY
XX27	SYNC BYTE
XX30 - XX7F	INTERLEAVE MAP

APPENDIX C

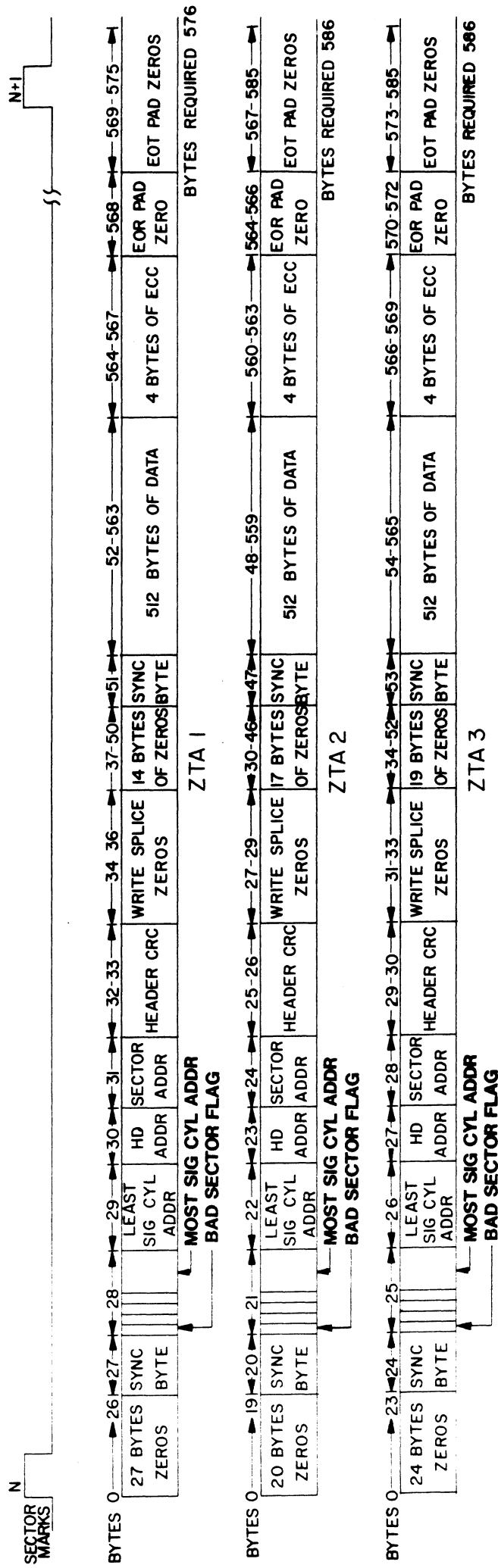



## APPENDIX D

### D.0 ENVOKING THE COMMAND STRING INTERPRETER

The Command String Interpreter is a diagnostic tool built into the Formatter and the Reliability programs on the Software Support Package tape.

To get into the Command String Interpreter, the Formatter or the Reliability program must be loaded into system memory. Once the Formatter or Reliability is in system memory, a control 0 should be done and an @ should appear on the console.

Next, key this into the console: 503R. This will issue a start from address 503 which is the Command String Interpreter's starting address. Questions must be answered the same as if the program was run from scratch until the point after entering the disk types.

You are now in the Command String and the following is an explanation of options the Command String allows.

### D.1 THE COMMAND STRING FUNCTIONS

All numbers entered above must be in octal. Any Non-octal input is treated as a letter. Any letter input for cyl, head, sector, or # of sectors gets random function in the Reliability test with options.

As a trouble-shooting aid, the Service Engineer may type in his own Test Loop. After starting at 503, three arguments must be entered in response to three program questions: "UNIT", "DATA", and "COMMAND STRINGS". All numbers must be entered in octal.

1. UNIT: TYPE UNIT # OR CARRIAGE TO  
USE THE PREVIOUS ENTRY

2. DATA: RAN=RANDOM

ALO=ALL ONES  
ALZ=ALL ZEROS  
PAT=155555 PATTERN  
ROT=155555 PATTERN ROTATED ON  
SUCCESSIVE PASSES.  
ALT=52525 PATTERN  
FLO=FLOATING ONE PATTERN  
FLZ=FLOATING ZERO PATTERN  
ADR=ALTERNATING CYLINDER AND  
HEAD, SECTOR WORDS  
VAR=EXISTING WORDS ENTERED PREVIOUSLY AS  
DESCRIBED BELOW

ALTERNATIVELY ENTER A STRING OF UP TO 7  
OCTAL 16 BIT WORDS TO BE  
USED AS DATA. THE WORDS  
ENTERED ARE USED REPEATEDLY  
TO MAKE UP A SECTOR BLOCK.  
TYPE CARRIAGE RETURN TO USE THE  
PREVIOUS ENTRY.

3. COMMAND STRING:

- OPTIONS
1. READ HEAD, SECTOR, #SECTORS
  2. WRITE SAME
  3. SEEK CYLINDER
  4. RECALIBRATE
  5. LOOP (GO TO BEGINNING OR LR)
  6. DELAY N (N= DELAY IN MS)
  7. DISABLE (WRITE DISABLE)
  8. TRESPASS
  9. STOP DISK
  10. RELEASE
  11. OFF (OFFSET FORWARD)
  12. OFR (OFFSET REVERSE)
  13. LR (BEGIN LOOP HERE)
  14. VERIFY (WRITE)
  15. MEMORY ADDR; DATA (WRITE) (CONTROLLER MEMORY  
COMMAND)
  16. TYPE CARRIAGE RETURN TO USE THE  
PREVIOUS COMMAND STRING.

NOTE THAT EITHER SPACES OR A COMMA MAY BE USED AS AN  
ARGUMENT DELIMITER. EACH RESPONSE IS TERMINATED  
BY TYPING CARRIAGE RETURN. IF MORE ROOM IS NEEDED ON  
A LINE, TYPE LINE FEED TO SPACE TO THE NEXT LINE.  
THE WORD "SAME" USED WITH READ OR WRITE, WILL  
CAUSE THE PREVIOUS DISK ADDRESS PARAMETERS TO BE USED.

AN "R" TYPED WHILE A STRING IS BEING EXECUTED WILL  
CAUSE THE PROGRAM TO RETURN TO THE COMMAND STRING  
START. THE ESCAPE KEY WILL BYPASS THE UNIT AND  
DATA PROMPTS TO THE COMMAND STRING PROMPT.



D.2 COMMAND STRING INTERPRETER EXAMPLES

THE FOLLOWING EXAMPLE WOULD CAUSE UNIT 1 TO SEEK CYLINDER 50, THEN REPEATEDLY WRITE SECTORS 2 AND 3 OF HEAD 5, THEN READ IT BACK AND CHECK. DATA IS SPECIFIED AS ALTERNATE WORDS OF ZEROS THEN ONES.

UNIT: 1  
DATA: 0,177777  
COMMAND STRING: SEEK 50 LR WRITE 5,2,2 READ SAME LOOP

THE FOLLOWING EXAMPLE WOULD WRITE ZERO TO CONTROLLER MEMORY LOCATION 1500 (OCTAL):

UNIT: 1  
DATA: N/A  
COMMAND STRING: MEMORY 101500,0  
NOTE: UPPER MEMORY BIT = 1 DEFINES A WRITE



## APPENDIX E

### E.0 FORMAT SWPAK REG BIT DEFINITIONS

Once the program starts executing, the state of any of the bits can be changed by hitting keys 1-9, A-F. The program will continue running after updating the options. Each key will complement the state of the bit affiliated with it; thus bit 4 can be altered by hitting key 4. Setting of any bit of location "SWREG" will set bit 0. (Default mode is defined as all bits of SWREG set to 0.)

Different bits and their interpretation in the "SWREG" is as follows:

BIT	OCTAL VALUE	BINARY VALUE	INTERPRETATION
1	40000	0	LOOP ON ERROR
		1	SKIP LOOPING ON ERROR
2	20000	0	PRINT TO CONSOLE
		1	ABORT PRINT OUT TO CONSOLE
5	02000	0	DO NOT PRINT ON THE LINE PRINTER
		1	PRINT ON THE LINE PRINTER
11(B)	00020	0	N/A
		1	ENABLE BAD SECTOR PRINTOUT
16(G)	100000	0	DO NOT PRINT ON THE LINE PRINTER
		1	PRINT ON THE LINE PRINTER (DC17)

Refer to the listings (white pages) at the very end of this manual for additional information.

## E.1 DIAGNOSTIC SWPAK REG DEFINITIONS

Once the program starts executing, the state of any of the bits can be changed by hitting keys 1-9, A-F. The program will continue running after updating the options. Each key will complement the state of the bit affiliated with it; thus bit 4 can be altered by hitting key 4. Setting of any bit of location "SWREG" will set bit 0. (Default mode is defined as all bits of SWREG set to 0.)

Different bits and their interpretation in the "SWREG" is as follows:

BIT	OCTAL VALUE	BINARY VALUE	INTERPRETATION
1	40000	0 1	LOOP ON ERROR SKIP LOOPING ON ERROR
2	20000	0 1	PRINT TO CONSOLE ABORT PRINT OUT TO CONSOLE
3	10000	0 1	DO NOT PRINT % FAILURE PRINT % FAILURE
5	02000	0 1	DO NOT PRINT ON THE LINE PRINTER PRINT ON THE LINE PRINTER
6	01000	0 1	DO NOT HALT ON ERROR HALT ON ERROR
7	00400	0 1	N/A EXECUTE A RE-FORMAT CHECK
8	00200	0 1	N/A RECALIBRATE DURING SCOPE LOOP
9	00100	0 1	N/A 1 SECOND DELAY DURING SCOPE LOOP
10(A)	00040	0 1	N/A PROGRAM WILL PRINT TEST #'S AND FIRMWARE REVISION
11(B)	00020	0 1	N/A PROGRAM WILL EXIT TO ODT WHEN NOT IN TESTS F1- ##SEE 7.5## SWITCH IS SET TO 0 UPON EXIT
12(C)	00010	0 1	SKIP LONG RAM TEST LONG CONTROLLER RAM TEST
16(G)	100000	0 1	DO NO PRINT ON THE LINER PRINTER PRINT ON THE LINE PRINTER (DC17)

## E.2 RELIABILITY SWPAK REG BIT DEFINITIONS

Once the program starts executing, the state of any of the bits can be changed by hitting keys 1-9, A-F. The program will continue running after updating the options. Each key will complement the state of the bit affiliated with it; thus bit 4 can be altered by hitting key 4. Setting of any bit of location "SWREG" will set bit 0. (Default mode is defined as all bits of SWREG set to 0.)

Different bits and their interpretation in the "SWREG" is as follows:

BIT	OCTAL VALUE	BINARY VALUE	INTERPRETATION
1	40000	0 1	LOOP ON ERROR SKIP LOOPING ON ERROR
2	20000	0 1	PRINT TO CONSOLE ABORT PRINT OUT TO CONSOLE
4	04000	0 1	PRINT PASS DO NOT PRINT PASS
5	02000	0 1	DO NOT PRINT ON THE LINE PRINTER PRINT ON THE LINE PRINTER
6	01000	0 1	DO NOT EXIT TO ODT ON ERROR EXIT TO ODT ON ERROR
7	00400	0 1	**** N/A BREAK FOR PACK INTERCHANGE
8	00200	0 1	**** N/A FOR READ ONLY MODE (SA 501,502)
9	00100	0 1	N/A BYPASS DATA CHECK
10(A)	00040	0 1	N/A DO VERIFY AFTER WRITE (SA 502 ONLY AND NOT RANDOM DATA)
11(B)	00020	0 1	N/A ENABLE BAD SECTOR PRINTOUTS
12(C)	00010	0 1	N/A HALT ON DRIVE ERROR PRIOR TO RECOVERY RECALIBRATE OPERATION
13(D)	00004	0 1	NO TRACE TRACE PRINTOUT ON ERROR
16(G)	100000	0 1	DO NOT PRINT ON THE LINE PRINTER PRINT ON THE LINE PRINTER (DC17)



## APPENDIX I

### 1.0 JUMPER MODIFICATIONS

Refer to Table 2.2 for Paddleboard Jumper Table.

### 1.1 BMX-3 MODE 1A CONFIGURATION

These changes are required on the BMX-3 (500-404-00), the "A" paddleboard (500-408-00), and the "B" paddleboard (500-409-00) when this controller is to be installed into the following computers: S250, C350, M600.

A BMX-3 with this feature installed will also function in the following computers with the exception of the power fail feature: S280, MV4000, MV10000 (Rev 03 or higher).

**\*\*WILL NOT RUN IN S140\*\***

#### 1.1.1 BMX-3 MODE 1A JUMPER MODIFICATIONS (See Figure 1.1)

1. Start with a working BMX-3 (500-404-00).
2. Configure jumper plug at location DD5 to Mode 1.
3. Configure jumper plug at location Z2 to Mode 1/Dual Port (top position).
4. Observe the 2 position jumper just below RP27, (lower right corner of board) labeled 1, 2, 3. Remove the jumper plug between feedthru 1 and 2. Place the jumper plug on feedthru 2 and 3.
5. Remove the jumper plug at location N1, turn it 180 degrees and reinsert it so that pin 1 identifier notch is pointing down.

#### 1.1.2 BMX-3 "A" PADDLEBOARD JUMPER MODIFICATIONS (See Figure 1.2)

1. Start with a working BMX-3 "A" paddleboard (500-408-00).
2. Remove jumper plug 1A, turn it so the arrow points toward the backplane connector and reinsert it.
3. Mode 2A jumper arrow should remain pointing towards backplane connector.

#### 1.1.3 BMX-3 "B" PADDLEBOARD JUMPER MODIFICATIONS (See Figure 1.2)

1. Start with a working BMX-3 "B" paddleboard (500-409-00).
2. Configure the 24-pin jumper plug to Mode 1.

3. Configure the 10-pin jumper plug to Mode 1 position/Mode 2 Dual Port. Reference Figure 2.2.
4. Remove jumper plug at W4 and place it on W3.
5. Ensure jumper W-2 is IN.

## 1.2 BMX-3 MODE 2A CONFIGURATION

These modifications are required on the BMX-3 (500-404-00), the "A" paddleboard (500-408-00), and the "B" paddleboard (500-409-00) when this controller is to be installed into the following computer(s): MV6000 Expansion Chassis.

The BMX-3, with this configuration, will also function in the following computers: S280, MV4000, MV10000 (Rev 03 or higher backplane).

**\*\*WILL NOT RUN IN S140\*\***

### 1.2.1 BMX-3 MODE 2A JUMPER MODIFICATIONS (See Figure 1.1)

1. Start with a working BMX-3 (500-404-00).
2. Configure jumper plug at location DD5 to Mode 2.
3. Remove jumper plug W34-2 and place it in W34-1.
4. Remove jumper plug W34-3 and place it in W34-4.
5. Remove jumper plug W34-5 and place it in W34-6.
6. Ensure jumper just below RP27, (lower right hand corner of board) labeled 1, 2, 3, is in position 1 and 2.
7. Ensure jumper located at N1 (pin 1 identifier notch) is pointed up.

### 1.2.2 BMX-3 "A" PADDLEBOARD (500-408-00) MODIFICATIONS (See Figure 1.2)

1. Start with a working BMX-3 "A" paddleboard (500-408-00).
2. Remove jumper plug at 2A, turn it so the arrow points away from the backplane connector and reinsert it.
3. Mode 1A jumper arrow should remain pointing away from the backplane connector.



1.2.3 BMX-3 "B" PADDLEBOARD (500-409-00) MODIFICATIONS  
(See Figure 1.2)

1. Start with a working BMX-3 "B" paddleboard (500-409-00).
2. Configure the 24-pin jumper plug to Mode 2.
3. Remove jumper plug at W2 and place it in W1.
4. Ensure jumper W4 is IN.

FIGURE I.1 Mode Jumper Layout

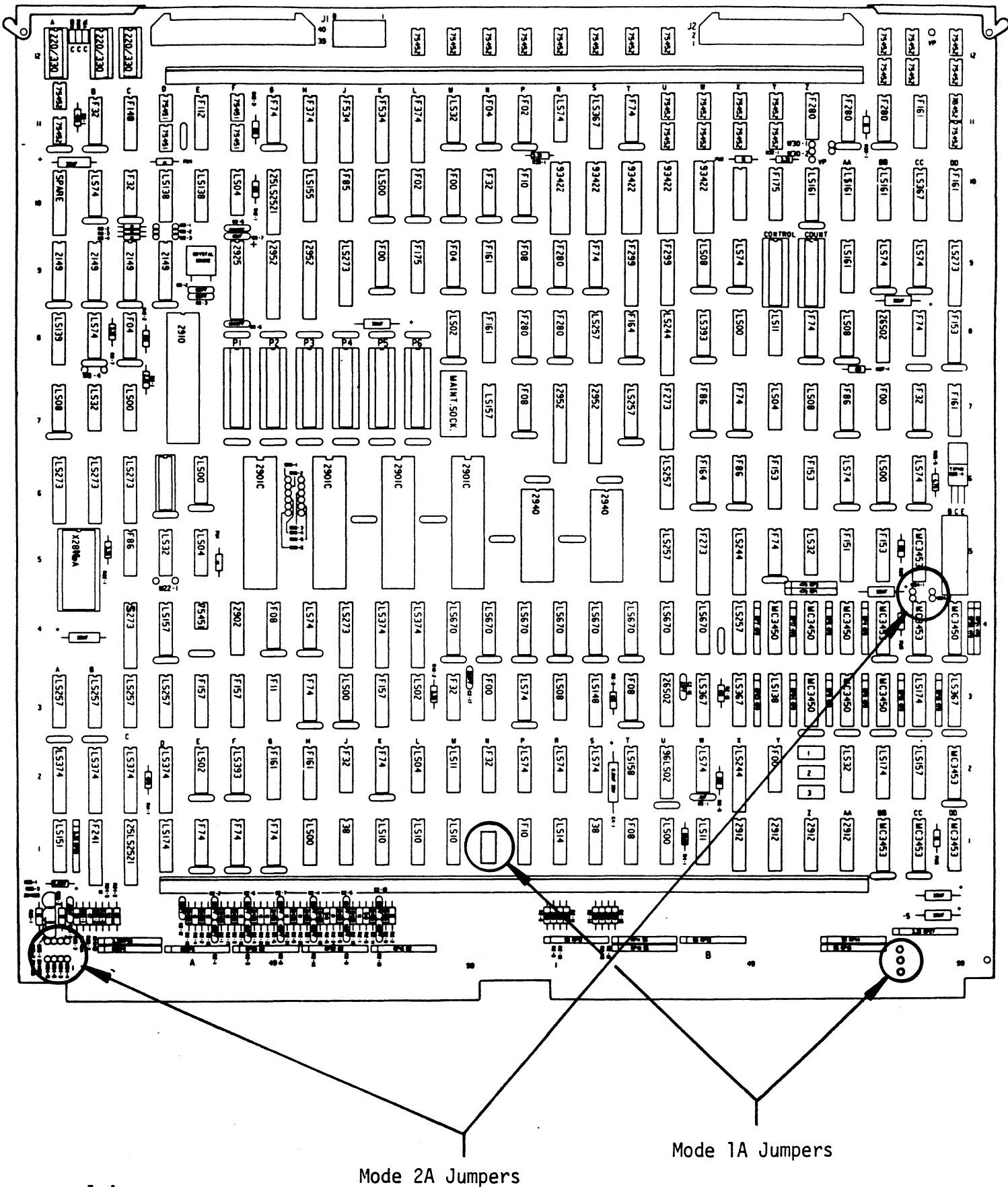
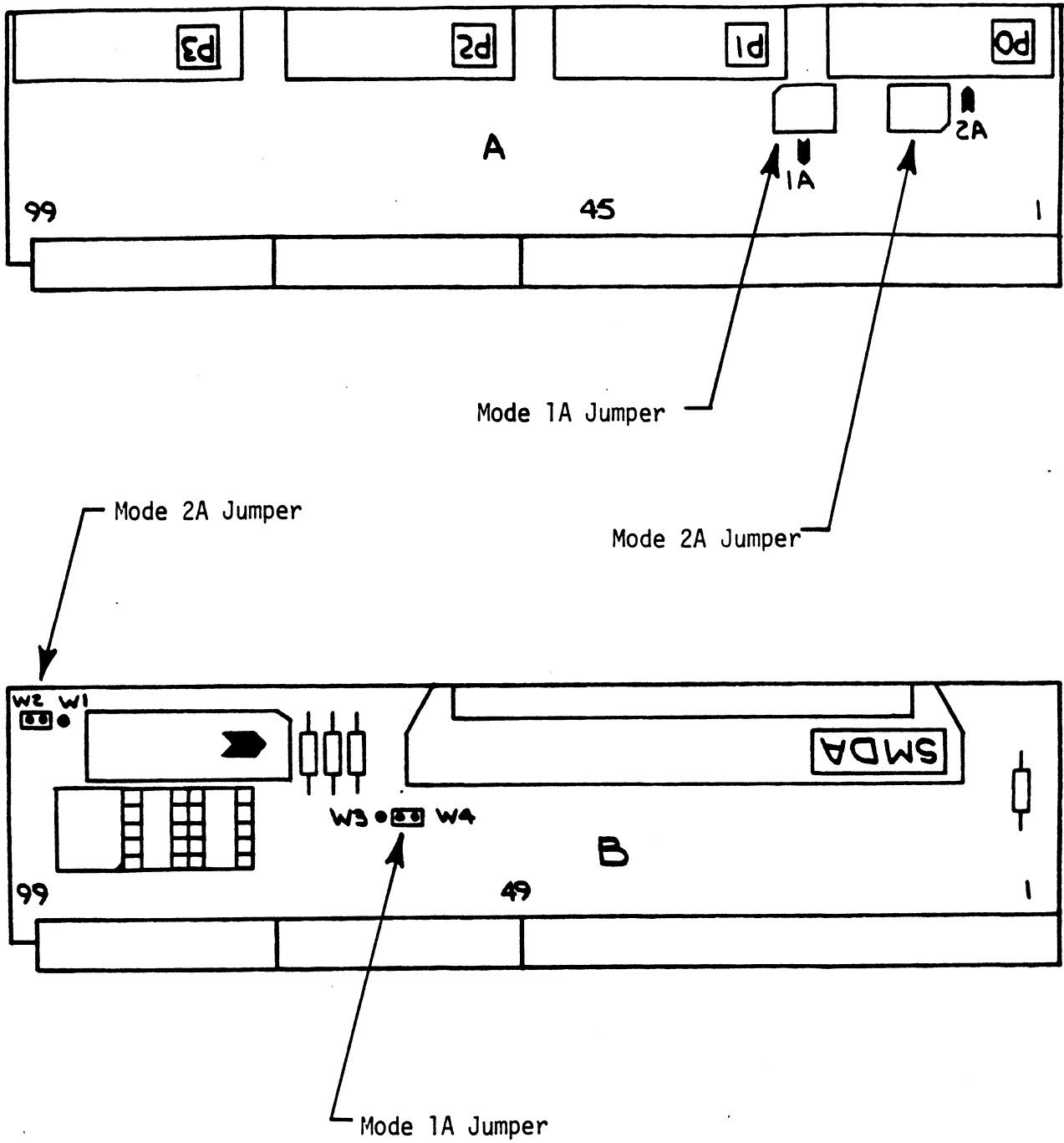

FIGURE I.2 Paddleboard Jumper Layout



\*\*\*\*\*

DESCRIPTION: ZETACO SMD DISK CONTROLLER DIAGNOSTIC

Product of ZETACO, 1985

\*\*\*\*\*

TITLE DISKD  
.DUSR X=1  
.NOMAC X

1.0 PROGRAM NAME: DISKD.SR

2.0 REVISION HISTORY:

REV.	DATE	
00	02/17/83	
01	09/07/83	; ANOTHER RDY UNIT WARNING, 1 HD ERR C22, ; AOS BOOTSTRAP(400'S), NO OFFSET TESTS ; FOR CMD'S
02	03/28/84	; 295C, 296 AND BMX TESTS ; DEVICE CODE CHANGE ROUTINE
03	06/12/84	; ZDF1 CHANGES, A5 TESTS 17-76
04	08/21/85	; DISABLE VIRTUAL, WEL-RECAL, DISK SIM PARMS

3.0 MACHINE REQUIREMENTS:

NOVA OR ECLIPSE FAMILY CENTRAL PROCESSOR  
MINIMUM OF 16K READ/WRITE MEMORY  
ZETACO SMD DISK CONTROLLER  
0-3 DISK DRIVES  
TELETYPE OR CRT AND CONTROL

4.0 TEST REQUIREMENTS: N/A

5.0 SUMMARY:

THIS PROGRAM IS A HARDWARE DIAGNOSTIC FOR THE  
ZETACO SMD DISK CONTROLLER AND DRIVES.  
THE DEVICE CODE MAY BE 20-76 OCTAL WITH THE  
DEFAULT BEING 27

6.0 RESTRICTIONS:

THIS PROGRAM HAS NO RESTRICTIONS AS TO SINGLE OR  
DUAL PROCESSOR HARDWARE CONFIGURATION. HOWEVER, THE  
DIAGNOSTIC MAY BE RUN ON ONLY ONE CPU AT A TIME AND  
MUST BE THE ONLY PROGRAM BEING RUN WITHIN THE DISK  
SYSTEM.

7.0 PROGRAM DESCRIPTION/THEORY OF OPERATION:

7.1 "A" TESTS CHECK:

- BUSY, DONE, I/O BUS SELECT LOGIC
- DISK SELECT LOGIC, CONTROLLER RAM

7.2 "B" TESTS CHECK:

- START, BUSY, CLEAR LOGIC
- RECALIBRATE, ATTN, INTERRUPT LOGIC

;8.2 SWITCH OPTIONS  
DIFFERENT BITS AND THEIR INTERPRETATION AT LOCATION  
"SWREG" IS AS FOLLOWS:

BIT	OCTAL VALUE	BINARY VALUE	INTERPRETATION
1	40000	0 1	LOOP ON ERROR SKIP LOOPING ON ERROR
2	20000	0 1	PRINT TO CONSOLE ABORT PRINT OUT TO CONSOLE
3	10000	0 1	DO NOT PRINT % FAILURE PRINT % FAILURE
5	02000	0 1	DO NOT PRINT ON THE LINE PRINTER PRINT ON THE LINE PRINTER
6	01000	0 1	DO NOT HALT ON ERROR HALT ON ERROR
7	00400	0 1	N/A DISABLE FORMATTING HEAD 0, CYLINDER 0, SECTOR 0 ##SEE 12.2##.
8	00200	0 1	N/A RECALIBRATE DURING SCOPE LOOP
9	00100	0 1	N/A 1 SECOND DELAY DURING SCOPE LOOP
10(A)	00040	0 1	N/A PROGRAM WILL PRINT TEST #'S AND FIRMWARE REVISIO
11(B)	00020	0 1	N/A PROGRAM WILL EXIT TO ODT WHEN NOT IN TESTS F1- ##SEE 7.5## SWITCH IS SET TO 0 UPON EXIT
12(C)	00010	0 1	SKIP LONG RAM TEST LONG CONTROLLER RAM TEST

;8.3 SWITCH COMMANDS  
ONCE THE PROGRAM STARTS EXECUTING THE STATE OF ANY OF  
THE BITS CAN BE CHANGED BY HITTING KEYS 1-9, A-F. THE  
PROGRAM WILL CONTINUE RUNNING AFTER UPDATING THE OPTIONS.  
EACH KEY WILL COMPLEMENT THE STATE OF THE BIT AFFILIAT-  
ED WITH IT, THUS BIT 4 CAN BE ALTERED BY HITTING KEY 4.  
SETTING OF ANY BIT OF LOCATION "SWREG" WILL SET BIT 0.  
(DEFAULT MODE IS DEFINED AS ALL BITS OF SWREG SET TO 0)

;8.4 OTHER COMMANDS (\* = CONTROL KEY)

- "CR" A "RETURN" CAN BE TYPED TO CONTINUE THE PROGRAM  
AFTER ITS LOCKED IN A SWITCH MODIFICATION MODE
- \*D THIS COMMAND GIVEN AT ANY TIME WILL RESET "SWREG"  
TO DEFAULT MODE AND RESTART THE PROGRAM.
- \*R THIS COMMAND GIVEN AT ANY TIME WILL RESTART THE  
PROGRAM. SWITCHES ARE LEFT WITH THE VALUES THEY  
HAD BEFORE THE COMMAND WAS ISSUED.
- \*O THIS COMMAND GIVEN AT ANY TIME WILL CAUSE THE

; C. INTERRUPT TIMEOUT

; MODE UNIT # DATA  
; CYL # HEAD # SECTOR #  
; INTERRUPT TIMEOUT

; ADDITIONAL TEST SIGNIFICANCE CAN BE FOUND IN THE PROGRAM  
; LISTING, ALTHOUGH IT IS HOPED THAT A NEED FOR THE  
; LISTING WILL BE MINIMAL. SWPACK(SWREG) WILL PROVIDE  
; ALL CONTROL OVER TEST LOOP OPTIONS AND PRINTOUTS.

; DATA ERRORS WILL RESULT IN THE 1ST 3 GOOD/BAD  
; PAIRS AND THEIR ADDRESSES BEING PRINTED ALONG WITH THE  
; TOTAL COUNT. IF AN ECC ERROR IS DETECTED, THE CALL  
; EHECC WILL ACKNOWLEDGE THE FACT AND RETURN TO THE  
; MAIN TEST FOR THE DATA COMPARE. PRINTOUTS RESULT  
; ON THE 1ST ERROR PASS ONLY. AS THE CHECK ROUTINE  
; CHECKS THE ENTIRE READ BUFFER, ANY ERROR ACCOMPANIED  
; BY AN ECC ERROR, TERMINATING THE READ, MAY CAUSE ALL  
; DATA IN SUCCEEDING SECTORS TO APPEAR BAD.

; TESTS THAT PERFORM A RECALIBRATE HAVE A 2 SEC.  
; DELAY BUILT INTO THE SCOPE LOOP. SET SWPAK 9 = 1  
; TO INTRODUCE AN ADDITIONAL 1 SECOND DELAY DURING  
; THE SCOPE LOOP.

; IN GENERAL EACH SUCCESSIVE TEST ASSUMES ALL  
; PREVIOUS TESTS WORK. BYPASSING ERRORS  
; CAN RESULT IN CONFUSING SITUATIONS  
; IN THE SETUP OF MORE COMPLEX TESTS.

; 11. DEBUG HELP:  
; O?DTD 11B

; 12. SPECIAL NOTES/SPECIAL FEATURES:

; 12.1 IF THE DISK PACK HAS BAD SECTOR FLAGS SET ON CYLINDER  
; 0, OR ON THE FIRST 8 SECTORS OF HEAD 0 OF ANY CYLINDER,  
; ERROR PRINTOUTS WILL RESULT WHEN THE FLAGS ARE  
; ENCOUNTERED.

; 12.2 TESTS F1-F3 ALTER THE FORMAT ON  
; CYL 0, HD 0, SEC 0 FOR PURPOSES OF  
; CHECKING THE FORMAT LOGIC AND BAD SECTOR LOGIC.  
; SWPAK7 SHOULD BE SET TO 1 IN ORDER TO STOP PROGRAM  
; FROM EXECUTING THE FORMAT.

; 12.3 SOME SCOPE LOOPS WILL REQUIRE A RECALIBRATE  
; TO INITIALIZE THE DISK DRIVE FOLLOWING A FAILURE.  
; SET SWPAK 8 = 1 TO INTRODUCE THE RECALIBRATE TO THE  
; UNIT UNDER TEST.

; 12.4 DISK PACKS  
; ONLY USE DISK PACKS FORMATTED BY THE DISKF  
; PACK FORMATTER PROGRAM. THE DIAGNOSTIC PROGRAM  
; WILL WRITE OVER MOST OF THE DISK SURFACE.

; 13. RUN TIME:  
; THE RUN TIME FOR A PASS IS APPROXIMATELY: 3 MIN.

; IS WRITTEN TO THE ENTIRE PACK AND READ BACK 2 TIMES,  
; A RANDOM SEEK TEST IS PERFORMED, AND PASS IS PRINTED.  
; THE DATA PATTERN IS THEN ROTATED  
; 1 BIT AND THE WRITE/READ/READ/SEEK PROCESS IS REPEATED.  
; AT THE COMPLETION OF THE NUMBER OF PASSES ENTERED  
; BY THE OPERATOR, A LOG IS PRINTED AND THE DRIVES  
; ARE RELEASED;

\*\*\*\*\*  
; ----- IT IS RECOMMENDED THAT AT LEAST 3 PASSES (W/R/R/S); WITH  
; ON-BOARD ECC SOFTWARE DISABLED; BE ALLOWED TO INSURE PACK  
; QUALITY. IF TIME PERMITS, LONGER RUNS WILL FURTHER INSURE  
; RELIABILITY.

\*\*\*\*\*  
; ----- ANY HARD DATA OR ADDRESS ERRORS WILL RESULT IN THE  
; BAD SECTOR FLAG BEING SET IN THAT SECTOR. ANY  
; "SOFT DATA" OR "ADDRESS ERROR" ADDRESS ENCOUNTERED  
; TWICE CAUSE THE BAD SECTOR FLAG TO BE SET. ANY OTHER  
; ERROR WILL CAUSE THE PROGRAM TO PRINT THE FAILURE TO  
; THE TTY AND THE PROGRAM WILL HALT. ##THIS PROGRAM IS NOT  
; INTENDED TO BE A RELIABILITY PROGRAM FOR THE DISK SYSTEM  
; AND IN GENERAL ASSUMES THE CONTROL AND DRIVE TO BE IN  
; WORKING ORDER.

; A HARD ADDRESS ERROR IS DEFINED AS SUCH AFTER TWO  
; ATTEMPTS HAVE BEEN MADE BOTH RESULTING IN AN ADDRESS  
; ERROR. A HARD DATA ERROR IS DEFINED AS SUCH AFTER  
; 2 OR MORE OF 10 WRITE/READ RETRY'S HAVE BEEN  
; UNSUCCESSFUL.

; B. CHECK PROGRAM ONLY (SA 501)  
; SAME AS SA 500 EXCEPT THAT INITIAL PACK FORMAT  
; OPERATION IS BYPASSED.

; C. STATISTICS  
; TYPE L FOR 1ST 200. DISK ADDRESSES OF BAD SECTORS,  
; DATA AND ADDRESS ERRORS, PLUS A STATISTIC TABLE OF  
; OVERALL ERRORS.  
; \*\*NOTE\*\* ANY CHARACTER TYPED WHILE EXECUTING  
; THIS LOG WILL END IT AT THE NEXT CHANGE OF  
; DATA TYPE.

; D. LOG RECOVERY (SA 502)  
; USE TO RECOVER LOG IF PROGRAM WAS STOPPED BEFORE  
; LOG PRINTOUT.

; E. COMMAND STRING INTERPRETER (SA 503)  
; AS A TROUBLE SHOOTING AID THE SERVICE  
; ENGINEER MAY TYPE IN HIS OWN TEST LOOP.  
; AFTER STARTING AT 503, THREE ARGUMENTS  
; MUST BE ENTERED IN RESPONSE TO THREE  
; PROGRAM QUESTIONS; "UNIT", "DATA", AND  
; "COMMAND STRING". ALL NUMBERS MUST ENTERED  
; IN OCTAL.

; I. UNIT: TYPE UNIT # OR CARRIAGE TO  
; USE THE PREVIOUS ENTRY

; II. DATA: RAN=RANDOM  
; ALO=ALL ONES  
; ALZ=ALL ZEROS  
; PAT=110110 PATTERN  
; FLO=FLOATING ONE PATTERN  
; FLZ=FLOATING ZERO PATTERN  
; ADR=ALTERNATING CYLINDER AND

COMMAND STRING: MEMORY 101500,0  
NOTE: UPPER MEMORY BIT = 1 DEFINES A WRITE

SWITCH SETTINGS  
S?WPD 8

SWITCH OPTIONS  
DIFFERENT BITS AND THEIR INTERPRETATION AT LOCATION  
"SWREG" IS AS FOLLOWS:

BIT	OCTAL VALUE	BINARY VALUE	INTERPRETATION
1	40000	0	LOOP ON ERROR
		1	SKIP LOOPING ON ERROR
2	20000	0	PRINT TO CONSOLE
		1	ABORT PRINT OUT TO CONSOLE
5	02000	0	DO NOT PRINT ON THE LINE PRINTER
		1	PRINT ON THE LINE PRINTER
11(B)	00020	0	N/A
		1	ENABLE BAD SECTOR PRINTOUT

OPERATING PROCEEDURE/OPERATOR INPUT:

A. VERIFY DRIVE (DRIVES) ARE READY ON-LINE  
B. LOAD PROGRAM USING BINARY LOADER  
C. TO RUN OTHER THAN TEST 500, ENTER CONTROL "0"  
AT 9.2, ENTER STARTING ADDRESS FOLLOWED BY AN "R"

STARTING ADDRESS (SA)

200 READ UNIT CHARACTERISTICS AND THEN RUN FORMATTER (500)  
500 FORMATTER/CHECK PROGRAM  
501 CHECK PROGRAM ONLY  
502 ERROR LOG RECOVERY (SEE 7.B,BA)  
503 COMMAND STRING INTERPRETER

OPERATOR IS REQUESTED TO ENTER DEVICE CODE OF  
CONTROLLER (DEFAULT 27)

OPERATOR IS REQUESTED TO SET SWPAK FOLLOWED  
BY A CARRIAGE RETURN (SEE 8:3)

MONTH, DAY, YEAR (I.E. 77...), HOUR, & MIN  
(IF [CR] IS GIVEN THIS ROUTINE IS BYPASSED)

ENTER # OF PASSES FOR TEST COMPLETION (IF [CR] IS  
GIVEN THIS ROUTINE IS BYPASSED)

OPERATOR IS REQUESTED TO ENTER YES/NO TO CONTROLLER  
CORRECTION, IF IT IS ENABLED

UNIT NUMBERS, TYPES, AND THEIR CHARACTERISTICS  
ARE THEN DISPLAYED, "PLEASE VERIFY"

OPERATOR IS THEN REQUESTED TO ENTER  
UNIT NUMBERS TO BE TESTED(0-3)

OPERATOR IS THEN REQUESTED TO ENTER  
TYPE OF DISK (USER DEFINED ENTER 10)

A. IF TYPE ENTERED DID NOT MATCH, ENTER 0  
1 2 OR 3 TO RE-DEFINE A DISK TYPE

B. # OF HEADS FOR NEW TYPE (IN DECIMAL)

C. # OF CYLINDERS FOR NEW TYPE (IN DECIMAL)

D. # OF SECTORS FOR NEW TYPE (IN DECIMAL, CANNOT BE DOWNSIZED)

E. RETURN TO 9.7



```

; DATA ERRORS - DATA IS REREAD 9 TIMES.
; IF DATA IS BAD ON 2 OR MORE OF
; 10 TRIES, A HARD ERROR COUNT IS INCREMENTED,
; THE BAD SECTOR FLAG IS SET IN THAT SECTOR, AND AN
; ERROR RETURN IS TAKEN. IF DATA IS GOOD ON ALL RETRIES,
; THE ERROR IS CONSIDERED SOFT AND A NORMAL RETURN IS
; TAKEN.

```

```

; THE 1ST 200. DATA ERRORS (HARD OR SOFT) ARE LOGGED.
;11.0 DEBUG HELP:
; O?DTD 11

```

```

;12.0 SPECIAL NOTES/SPECIAL FEATURES:

```

```

; 1. THE PROGRAM IS INOTI A MAINTENANCE PROGRAM
; AND ASSUMES THE HARDWARE TO BE IN WORKING ORDER.
; THE PROGRAM WILL HALT ON ANY NON-DATA RELATED
; ERRORS. ALTHOUGH PRESSING CONTINUE WILL ALLOW
; THE PROGRAM TO PROCEED, IT IS NOT RECOMMENDED
; THAT THE PROGRAM BE RUN UNDER THESE CONDITIONS.

```

```

; 2. IT IS RECOMMENDED THAT AT LEAST 3 PASSES (W/R/R/S)
; BE ALLOWED (SEE BELOW) TO INSURE PACK QUALITY.
; IF TIME PERMITS, LONGER RUNS WILL FURTHER
; INSURE QUALITY.

```

```

;13.1 PROGRAM RUNTIME:

```

```

; PROGRAM RUNTIMES ARE SUBSTANTIALLY REDUCED WITH
; MEMORIES OF 24K OR LARGER. RUNTIMES ARE ALSO
; DEPENDANT ON CPU TYPE, DRIVE SIZE AND DRIVE TYPE.

```

```

; 3 PASSES AFTER FORMAT ARE RECOMMENDED FOR
; SURFACE VERIFICATION:

```

```

; READ, WRITE AND SEEK OPERATIONS ARE TIMED
; BY SPECIAL ROUTINES. WHEN THE PROGRAM IS
; FIRST STARTED, THE TIMING ROUTINE WILL TEST
; FOR THE PRESENCE OF A REAL TIME CLOCK (RTC)
; TO DERIVE TIMING FROM IT.
;EOT

```

; SHARED BETWEEN TWO COMPUTERS IN WHICH CASE  
; THE FOLLOWING PROGRAMS MAY BE RUNNING IN EACH  
; COMPUTER:

; STARTING ADDRESSES'S (SA) 500,501 RANDOM RELIABILITY  
; SA 503 COMMAND STRING (IF A RELEASE COMMAND IS  
; INCLUDED IN THE COMMAND STRING)

; IF NO DRIVES ARE TO BE SHARED, THERE ARE NO OTHER  
; RESTRICTIONS AS TO THE RUNNING OF THESE PROGRAMS ON  
; A DUAL PROCESSOR SYSTEM.

; 2. ANY COMBINATION OF DRIVES  
; MAY BE TESTED BY THIS PROGRAM AT A SINGLE TIME.

;7.0 PROGRAM DESCRIPTION/THEORY OF OPERATION:

; A. RELIABILITY TEST (SA 500)

; A RANDOM NUMBER GENERATOR IS USED TO SELECT A  
; DISK DRIVE,CYLINDER,HEAD,BEGINNING SECTOR,  
; AND NUMBER OF CONSECUTIVE SECTORS. RANDOM  
; DATA IS THEN GENERATED, WRITTEN, AND READ.  
; THE SEQUENCE IS REPEATED INDEFINITELY.  
; IF RUNNING MULTIPLE UNITS, OVER LAPPED SEEKS ARE  
; EMPLOYED IF THE NEXT RANDOM UNIT IS DIFFERENT FROM  
; THE CURRENT UNIT UNDER I/O EXECUTION.

; B. RELIABILITY TEST (SA 501) WITH OPTIONS

; SAME AS A, EXCEPT THAT OPERATOR IS GIVEN  
; OPTIONS ON DATA PATTERNS (SEE 7D 11)  
; AND MAY CHOOSE A CONSTANT CYLINDER,HEAD,SECTOR  
; OR # OF SECTORS. ANY LETTER RESPONSE TO CYL,HEAD ETC.  
; GETS RANDOM FUNCTION FOR THAT VARIABLE. A CARRIAGE  
; RETURN ONLY GETS THE RANDOM FUNCTION FOR ALL VARIABLES.

; THE OPERATOR IS ALSO ASKED TO RESPOND TO  
; JITTER OPTION(YES/NO). IF YES, A RANDOM DELAY(0-40,50MS)  
; IS INSERTED INTO THE BACKGROUND LOOP TO CREATE  
; A MORE ASYNCHRONOUS DISK I/O LOOP.

; C. INCREMENTAL DISK ADDRESS TEST (SA 502)

; OPERATOR IS GIVEN OPTION ON DATA (SEE 7D 11)  
; REQUESTED DATA IS FIRST WRITTEN (SEE SWPAK10) OVER  
; THE ENTIRE PACK. THEN THE DATA IS READ FROM  
; ALL SECTORS . THIS INSURES THAT ALL DISK  
; PACK BLOCKS ARE USEABLE AND ARE FORMATTED  
; PROPERLY. THE TEST IS THEN REPEATED FOR ALL  
; READY DISCS; AND PASS IS PRINTED. THE  
; SEQUENCE IS REPEATED INDEFINITELY.

; #NOTE

; SWPAK7=1, PROGRAM WAITS AFTER WRITE WITH READ  
; VERIFICATION ALLOWING OPERATOR TO CHANGE PACKS.  
; SWPAK8=1; PUTS PROGRAM INTO READ ONLY MODE  
; ## SA'S 501,502 ONLY. IF SA 501-DATA MUST INOT! BE  
; RANDOM (SEE 7D 11).

; ALL NUMBERS ENTERED ABOVE MUST BE IN OCTAL.  
; ANY NON-OCTAL INPUT IS TREATED AS A LETTER.  
; ANY LETTER INPUT FOR CYL,HEAD,SECTOR, OR # OF

; THE WORD "SAME" USED WITH READ, OR WRITE,  
; WILL CAUSE THE PREVIOUS DISK  
; ADDRESS PARAMETERS TO BE USED.

; AN R TYPED WHILE A STRING IS BEING EXECUTED  
; WILL CAUSE THE PROGRAM TO RETURN TO THE  
; COMMAND STRING START. THE ESCAPE KEY WILL  
; BYPASS THE UNIT AND DATA PROMPTS TO THE  
; COMMAND STRING PROMPT.

; THE FOLLOWING EXAMPLE WOULD CAUSE UNIT  
; 1 TO SEEK CYLINDER 50, THEN REPEATEDLY  
; WRITE SECTORS 2 AND 3 OF HEAD 5,  
; THEN READ IT BACK AND CHECK. DATA IS SPECIFIED  
; AS ALTERNATE WORDS OF ZEROS THEN ONES.

; UNIT: 1  
; DATA: 0,177777  
; COMMAND STRING: SEEK 50 LR WRITE 5,2,2 READ SAME LOOP

; THE FOLLOWING EXAMPLE WOULD WRITE ZERO TO  
; CONTROLLER MEMORY LOCATION 1500 (OCTAL)

; UNIT: 1  
; DATA: N/A  
; COMMAND STRING: MEMORY 101500,0  
; NOTE: UPPER MEMORY BIT = 1 DEFINES A WRITE

; E. QUICKIE FORMATTER (SA 504)  
; FORMATS PACK AND HALTS. THERE IS NO VERIFY,  
; NO FLAGS ARE SET, AND NO ERROR CHECKING.

; F. RUNALL (SA 505)  
; PROGRAM ALTERNATES BETWEEN THE PROGRAMS DESCRIBED  
; IN 7.B(4 DATA PATTERNS -PAT,RAN,FLZ,FLO) AND  
; 7.C(6 DATA PATTERNS -PAT,RAN,ADR,ALT1,ZEROES,ONES)  
; AND 7.H, AND IN THAT ORDER.

; G. SEEK EXERCISER (SA 506)  
; PROGRAM PROVIDES A SEEK SCAN SEQUENCE  
; CONVERGING FROM THE EXTREME OUTERMOST TRACKS INTO THE  
; ADJACENT TRACK IN THE CENTER, THEN DIVERGING AGAIN TO  
; THE EXTREMES.

; H. RANDOM SEEK EXERCISER (SA 507)  
; PROGRAM PROVIDES A RANDOM SEEK SEQUENCE

; ###G,H ALL SEEKS IN G/H ARE FOLLOWED BY A 1 SECTOR READ  
; BUT WITH NO DATA CHECK. ALL SEEKS ARE TIMED  
; WITH MAX,MIN, AND AVE. TIMES BEING LOGGED IN MS.  
; SEEK PATHS FOR MAX,MIN VALUES ARE ALSO LOGGED.  
; ###CAUTION -ECC ERRORS WILL RESULT IN SA'S 506,507 IF  
; PACK IS NOT 1ST WRITTEN AFTER FORMATTING.

; I. ERROR COUNT/LOG RECOVERY (SA 510)  
; IN THE EVENT A PROGRAM WAS STOPPED DURING A RUN, THE  
; ERROR LOGS MAY BE RECOVERED AT THIS STARTING ADDRESS.  
; \*\*\*MUST BE DONE BEFORE ANY PROGRAM RESTART AS PROGRAM  
; INITIALIZATION ZEROES ALL LOGS.

;8. SWITCH SETTINGS  
; S?WPD 8  
;8.3 SWITCH OPTIONS

```

; CONTROLLER (DEFAULT IS 27)
;9.2 STARTING ADDRESS IS DISPLAYED AND
; OPERATOR IS REQUESTED TO SET SWPAK FOLLOWED
; BY A CARRIAGE RETURN (SEE 8:3)
;9.3 OPERATOR IS REQUESTED TO ENTER YES/NO TO
; EXERCISE MAPS, IF PRESENT
; 9.4 DATE -DAY, MONTH, YEAR (I.E. 77...), HOUR, & MINUTE (A [CR]
; RESPONSE WILL IGNORE THIS ROUTINE)
;9.5 OPERATOR IS REQUESTED TO ENTER YES/NO IF ANY
; DUAL VOLUME DRIVES (CMD'S)
;9.6 OPERATOR IS REQUESTED TO ENTER YES/NO TO CONTROLLER
; CORRECTION, IF IT IS ENABLED
;9.7 UNIT NUMBERS, TYPES, AND THEIR CHARACTERISTICS
; ARE THEN DISPLAYED, "PLEASE VERIFY"
; OPERATOR IS THEN REQUESTED TO ENTER
; UNIT NUMBERS TO BE TESTED (0-3)
;9.8 OPERATOR IS THEN REQUESTED TO ENTER
; TYPE OF DISK (USER DEFINED ENTER 10)
; A. IF TYPE ENTERED IS 10; ENTER 0
; 1 2 OR 3 TO RE-DEFINE A DISK TYPE
; B. # OF HEADS FOR NEW TYPE (IN DECIMAL)
; C. # OF CYLINDERS FOR NEW TYPE (IN DECIMAL)
; D. # OF SECTORS FOR NEW TYPE (IN DECIMAL, CANNOT BE DOWNSIZED)
; E. RETURN TO 9.7

; ## A [CR] ONLY RESPONSE TO UNIT NUMBERS, WILL LEAVE
; UNIT INFORMATION IN PREVIOUS STATE.

; ## A [CR] ONLY RESPONSE TO YES/NO WILL
; DEFAULT TO NO

; OPERATOR INPUT CONTROLLED PRINTOUTS ARE AS FOLLOWS:

; L = FIRST 100. BAD SECTORS, DATA, OR ADDRESSES
; S = SEEK TIMING STATISTICS (506,507 ONLY)
; W = SECTORS W/R, ERROR COUNTS, AND ON BOARD ECC AND OFFSET CORRECT
; **NOTE** ANY CHARACTER TYPED WILL END PRINTOUTS AT THE
; NEXT CHANGE OF DATA TYPE.

; D. OPERATING MODES

; 1 OF 4 DIFFERENT MEMORY/INTERRUPT MODES MAY BE IN USE
; IN THIS PROGRAM AND ARE DESCRIBED AS FOLLOWS:

; 1-BACKGROUND ONLY, WAIT ON INTERRUPT.
; MAX # OF SECTORS = ALL OF AVAILABLE CORE (IE NOT TAKEN
; BY PROGRAM) OR 32 SECTORS MAX. USED FOR SA'S 503,506,507

; 2-BACKGROUND/FOREGROUND MODES, 2 BUFFERS USED FOR
; BOTH READ AND WRITE PURPOSES. MAX # OF SECTORS
; = 1/2 OF AVAILABLE CORE OR 32 SECTORS MAX. USED
; FOR CONSTANT DATA PATTERNS.

; 3.-BACKGROUND/FOREGROUND MODES, 4 BUFFERS ( 2 FOR READ
; AND 2 FOR WRITE). MAX # OF SECTORS =1/3 OF AVAILABLE
; CORE OR 32. MAX. USED FOR VARIABLE DATA(EXPECT ADR).

; 4. -IF THE ECLIPSE OR NOVA-3 MAPS ARE IN THE SYSTEM,
; AND MAPPING IS REQUESTED, ONE OF TWO MAPPING SCHEMES
; WILL BE IN EFFECT.

; 4.1 THE 1ST N PHYSICAL 1K BLOCKS CONTAINING THE PROGRAM
; WILL BE MAPPED TO THE 1ST N 1K LOGICAL BLOCKS IN BOTH
; THE A AND B USER MAPS. THIS MAPPING WILL REMAIN

```

; THE SECOND TIME, INCREMENT THE SOFT ADDRESS ERROR  
; COUNT AND DO A NORMAL RETURN; OTHERWISE INCREMENT  
; THE HARD ADDRESS ERROR COUNT AND DO AN ERROR RETURN

; IF A HARD CYLINDER ADDRESS ERROR OCCURS, A READ  
; ON AN ADJACENT HEAD WILL BE ATTEMPTED TO DETERMINE  
; WHETHER THE FAULT SHOULD BE CLASSED AS A SEEK ERROR  
; OR AN ADDRESS ERROR. THE FIRST 20. ADDRESS  
; ERRORS WILL HAVE THEIR ADDRESSES LOGGED.

; 3. BAD SECTOR- LOG THE DISK ADDRESS (1ST 100.) AND DO  
; A NORMAL RETURN. NO PRINTOUT WILL RESULT UNLESS SW11=1,  
; ALTHOUGH THE I/O OPERATION WAS PREMATURELY TERMINATED.  
; A "SOFT" ERROR WILL BE RECORDED IF THE SECTOR UNDER  
; TEST PASSES AT LEAST 1 OF 4 RETRYS. THE LOG DENOTES  
; SOFT ERRORS BY A COUNT GREATER THAN 0; REPRESENTING  
; THE ERROR COUNT TALLIED.  
; \*\*\*SEE 10.3A.

; 4. ENDING MEMORY ADDRESS - INCREMENT THE MEMORY ADDRESS  
; ERROR COUNT, PRINT THE ERROR MESSAGE, CHECK FOR A  
; DISK ADDRESS ERROR AND DO AN ERROR RETURN

; 5. ENDING DISK ADDRESS - INCREMENT THE DISK ADDRESS  
; ERROR COUNT, PRINT THE ERROR MESSAGE, AND  
; DO AN ERROR RETURN

; 10.3 READ - ALL READ ERRORS WITH THE EXCEPTION OF DATA RELATED  
; ERRORS ARE HANDLED THE SAME AS DESCRIBED FOR THE WRITE  
; OPERATIONS

; DATA ERRORS - DATA IS REREAD 3 X (4X IF ECC UNDETECTED)  
; IF PROGRAM IS IN WRITE/READ MODE AND DATA IS BAD ALL  
; 4 TRIES, A HARD ERROR COUNT IS INCREMENTED AND AN  
; ERROR RETURN IS TAKEN. IF DATA IS GOOD ON ANY OF FOUR  
; TRIES, A SOFT ERROR COUNT IS INCREMENTED AND A  
; NORMAL RETURN IS TAKEN

; IF THE PROGRAM IS IN A READ ONLY MODE (IE. READ MODE  
; FOR ANY 502 PROGRAM OR WHEN 505 IS RUNNING A 502  
; PROGRAM), THE DATA WILL BE REREAD AN ADDITIONAL  
; 4 TIMES IN BOTH OFFSET FORWARD AND OFFSET REVERSE  
; MODES BEFORE THE PROBLEM IS CLASSED AS A HARD ERROR

; THUS TOTAL RETRIES FOR A HARD ECC DETECTED ERROR IN  
; A READ ONLY MODE IS 12 (13 FOR ECC UNDETECTED), AND  
; 4 IF IN A WRITE/READ MODE (5 IF ECC UNDETECTED).  
; \*\*\*SEE 10.3A

; ANY SUCCESSFUL REREADS WHILE IN AN OFFSET MODE  
; WILL BE PRINTED AND LOGGED. THE DISK ADDRESSES  
; OF ALL DATA PROBLEMS WILL BE PRINTED AND THE FIRST  
; 100. WILL BE LOGGED. THE FIRST THREE GOOD/BAD  
; WORD PAIRS AND RESPECTIVE ADDRESSES WILL BE PRINTED.

; IF SWPAK9=1 (BYPASS DATA CHECK) HARD OR SOFT DATA  
; ERRORS WILL BE DETERMINED BY ECC STATUS.

; 10.3A ECC (ERROR CORRECTION CODE) ANALYSIS

; ALL READ PASSES INCLUDING RETRIES WILL HAVE THE ECC  
; RESULTS LOGGED AS PER THE FOLLOWING 4 CATEGORIES:

; WHERE CYL, HEAD, SECT REFER TO THE FINAL DISK ADDRESS AT  
; THE POINT OF ERROR; AND #SECT REFERS TO THE NUMBER OF  
; SECTORS ALREADY DONE IN THE MULTIPLE SECTOR TRANSFER.

; WHEN DATA ERRORS ARE FOUND, ONLY THREE ARE PRINTED PER  
; ENCOUNTER PLUS THE TOTAL NUMBER OF ERRORS. (SEE PARA 5)  
; IF THE DATA ERROR IS ECC UNDETECTED AND THE SYSTEM IS  
; MAPPED, THE MAP, PHYSICAL 1K ADDRESS, AND THE DCH  
; LOGICAL ADDRESSES ARE ALSO PRINTED.

; WHEN LOOPING IS INVOLVED (RETRIES OR FOR SCOPING)  
; STATUS IS PRINTED ON THE 1ST PASS ONLY.

;10.5 STATISTICS - TYPE A W  
; DURING RANDOM TESTING TO GET A REPORT OF THE  
; NUMBER OF SECTORS WRITTEN(AND/OR)READ, PLUS  
; ERROR COUNTS IN DECIMAL. ALSO LISTED IS A  
; COUNT FOR CONTROLLER CORRECTS/UNIT  
; (ON BOARD ECC CORRECTION AND OFFSET CORRECTS)

; TYPE L FOR FIRST 100. DISK ADDRESSES OF BAD SECTORS AND  
; DATA ERRORS, AND FIRST 20. OF ADDRESS ERRORS AND  
; SEEK ERRORS (SEEK PATH). IF ERROR ADDRESSES ARE  
; ENCOUNTERED MORE THAN ONCE (1ST PASS), A COUNT OF UP TO  
; 32. WILL BE RECORDED IN THE LOG. ALSO A COUNT OF UP TO  
; 15. HARD ERRORS WILL BE RECORDED. THIS COUNT WILL BE  
; A SUBSET OF THE THE FIRST COUNT.

; THE ADDRESS INFORMATION WILL BE IN OCTAL WHILE THE  
; COUNTS WILL BE DECIMAL.

; TYPE S FOR SEEK TIMING STATISTICS IF RUNNING  
; EITHER SEEK EXERCISER.

; \*\*\*\*\* NOTE \*\*\*\*\*

; THE PROGRAM WILL ACCOUNT FOR UP TO A MAX.  
; OF 2\*\*31 SECTORS WRITTEN OR READ; SPECIAL  
; TEST RUNS EXCEEDING THIS FACILITY WILL  
; REQUIRE AN OPERATOR'S TEST LOG TO AUGMENT  
; SOFTWARE ACCOUNTING. 2\*\*31 SECTORS =  
; APPROX. 5.5\* 10\*\*11 WORDS.

;11.0 DEBUG HELP:  
O?DTD 11

;12.0 SPECIAL NOTES/SPECIAL FEATURES:

; 1. A CR ONLY RESPONSE TO UNIT NUMBERS, WILL LEAVE  
; UNIT/CYLINDER INFORMATION IN PREVIOUS STATE.

; 2. THE PROGRAM USES A 10 WORD BUFFER.

; 3. THE PROGRAM WILL ACCOUNT FOR UP TO A MAX.  
; OF 2\*\*31 SECTORS WRITTEN OR READ. SPECIAL  
; TEST RUNS EXCEEDING THIS FACILITY WILL  
; REQUIRE AN OPERATOR'S TEST LOG TO AUGMENT  
; SOFTWARE ACCOUNTING. 2\*\*31 SECTORS =  
; APPROX. 5.5\* 10\*\*11 WORDS.

; 4. SWPAK7=1, PROGRAM HALTS AFTER WRITE WITH READ  
; VERIFICATION ALLOWING OPERATOR TO CHANGE PACKS.  
; SWPAK8=1; PUTS PROGRAM INTO READ ONLY MODE  
; ## SA'S 501,502 ONLY. IF SA 501-DATA MUST INOT! BE  
; VARIABLE. START AT THE ABOVE SELECTED ADDRESS.

PARTS LIST  
ZETACO

FOR: INTERNAL A CABLE ASSY 18"

ASSEMBLY #: 300-000-00  
REV. LEVEL: C

ITEM	QTY	PART #	GENERIC DESCRIP.	DESCRIPTION	REFERENCE
1	1	025-049-00	CONN F	AMP 204508-3	
2	60	029-012-00	CONN PIN F	AMP 66717-5	
3	1	030-043-00	CONN HDWE	D20418-2 HEX SET	
4	0	020-020-00	CABLE	455-248-60 28 AWG SPECTRA	
5	1	025-041-00	CONN F	3M 3334-6060	
6	1	030-034-00	CONN HDWE	3M 3490-5 PULL TAB	
7	1	099-010-00	LABEL	1/2" X 1 3/4" WHITE PAPER	
8	0	010-001-00	TAPE	3M 850 1"	
9	0	018-029-00	CABLE MATL	805036	

# WIRE LIST

NOTES	WIRE GAUGE	COLOR	ORIGIN	TERM. METHOD	DESTINATION	TERM. METHOD	REMARKS
TWP ↑	28 ↑	BRN TAN	P1-1 ↑	MASS ↑	P2-1 P2-2	3 ↑	
		RED TAN			P2-3 P2-4		
		ORG TAN			P2-5 P2-6		
		YEL TAN			P2-7 P2-8		
		GRN TAN			P2-9 P2-10		
		BLU TAN			P2-11 P2-12		
		VIO TAN			P2-13 P2-14		
		GRY TAN			P2-15 P2-16		
		WHT TAN			P2-17 P2-18		
		BLK TAN			P2-19 P2-20		
		BRN TAN			P2-21 P2-22		
		RED TAN			P2-23 P2-24		
		ORG TAN			P2-25 P2-26		
		YEL TAN			P2-27 P2-28		
↓ TWP	↓ 28	GRN TAN	↓ P1-45	↓ MASS	P2-29 P2-30	↓ 3	

ZETACO

TITLE

INTERNAL A CABLE ASSEMBLY

DOCUMENT NO. 300-000-00 thru 300-000-02

SHEET 2 OF 3

REV. C



# WIRE LIST

NOTES	WIRE GAUGE	COLOR	ORIGIN	TERM. METHOD	DESTINATION	TERM. METHOD	REMARKS
TWP ↑	28 ↑	BLU TAN	P1-16 ↑	MASS ↑	P2-31 P2-32	3 ↑	
		VIO TAN			P2-33 P2-34		
		GRY TAN			P2-35 P2-36		
		WHT TAN			P2-37 P2-38		
		BLK TAN			P2-39 P2-40		
		BRN TAN			P2-41 P2-42		
		RED TAN			P2-43 P2-44		
		ORG TAN			P2-45 P2-46		
		YEL TAN			P2-47 P2-48		
		GRN TAN			P2-49 P2-50		
		BLU TAN			P2-51 P2-52		
		VIO TAN			P2-53 P2-54		
		GRY TAN			P2-55 P2-56		
		WHT TAN			P2-57 P2-58		
↓ TWP	↓ 28	BLK TAN	↓ P1-60	↓ MASS	P2-59 P2-60	↓ 3	

*ZETACO*

TITLE

INTERNAL A CABLE ASSEMBLY

DOCUMENT NO. 300-000-00 thru 300-000-02

SHEET 3 OF 3

REV. C

PARTS LIST  
ZETACO

FOR: EXTERNAL B CABLE ASSEMBLY 16'

ASSEMBLY #: 300-011-01  
REV. LEVEL: C

ITEM	QTY	PART #	GENERIC DESCRIP.	DESCRIPTION	REFERENCE
----	----	-----	-----	-----	-----
1	1	026-027-00	CONN M	AMP 50P PLUG 205212-3	
2	26	028-008-00	CONN PIN M	AMP 66507-2	
3	1	030-038-00	CONN HDWE	AMP 1-747098-1 13 PR CBL	
4	1	030-037-00	CONN HDWE	AMP 205980-1	
5	1	030-017-00	CONN HDWE	1-745129-7 FERRULE IN	
6	1	030-019-00	CONN HDWE	1-745130-0 FERRULE OUT	
7	0	020-003-00	CABLE	SHIELDED 13 TWP 28 AWG	16 FT
8	1	025-037-00	CONN F	3M 3399-6026	
9	1	030-034-00	CONN HDWE	3M 3490-5 PULL TAB	
10	1	099-011-00	LABEL	SLSH-20375 BRADY RND CBL	

# WIRE LIST

NOTES	WIRE GAUGE	COLOR	ORIGIN	TERM. METHOD	DESTINATION	TERM. METHOD	REMARKS
TWP ↑		BRN BLK	P1-1 ↑	MASS ↑	P2-1 P2-2	3 ↑	
		RED BLK			P2-3 P2-4		
		ORG BLK			P2-5 P2-6		
		YEL BLK			P2-7 P2-8		
		GRN BLK			P2-9 P2-10		
		BLU BLK			P2-11 P2-12		
		VIO BLK			P2-13 P2-14		
		GRY BLK			P2-15 P2-16		
		WHT BLK			P2-17 P2-18		
		RED BRN			P2-19 P2-20		
		ORG BRN			P2-21 P2-22		
		YEL BRN			P2-23 P2-24		
↓ TWP		GRN BRN	↓ P1-26	↓ MASS	P2-25 P2-26	↓ 3	

ZETACO

**TITLE**  
EXTERNAL "B" CABLE ASSEMBLY

**DOCUMENT NO.** 300-011-00 thru 300-011-02

**SHEET** 2 **OF** 2 **REV.** C

PARTS LIST  
ZETACO

FOR: EXTERNAL A CABLE ASSEMBLY 16'

ASSEMBLY #: 300-013-01  
REV. LEVEL: C

ITEM	QTY	PART #	GENERIC DESCRIP.	DESCRIPTION	REFERENCE
----	----	-----	-----	-----	-----
1	1	026-023-00	CONN M	AMP 204509-3	
2	60	028-009-00	CONN PIN M	AMP 66718-4	
3	1	030-039-00	CONN HDWE	AMP 1-747098-7 30PR CABLE	
4	1	030-037-00	CONN HDWE	AMP 205980-1	
5	1	030-018-00	CONN HDWE	2-745129-3 FERRULE IN	
6	1	030-020-00	CONN HDWE	1-745130-1 FERRULE OUT	
7	0	020-016-00	CABLE	REX T-7978-30PR, 28 AWG	16 FT
8	1	025-041-00	CONN F	3M 3334-6060	
9	1	030-034-00	CONN HDWE	3M 3490-5 PULL TAB	
10	1	099-011-00	LABEL	SLSH-20375 BRADY RND CBL	

# WIRE LIST

NOTES	WIRE GAUGE	COLOR	ORIGIN	TERM. METHOD	DESTINATION	TERM. METHOD	REMARKS
TWP ↑		BRN BLK	P1 ↑	MASS	P2-1 P2-2	3 ↑	
		RED BLK			P2-3 P2-4		
		ORG BLK			P2-5 P2-6		
		YEL BLK			P2-7 P2-8		
		GRN BLK			P2-9 P2-10		
		BLU BLK			P2-11 P2-12		
		VIO BLK			P2-13 P2-14		
		GRY BLK			P2-15 P2-16		
		WHT BLK			P2-17 P2-18		
		RED BRN			P2-19 P2-20		
		ORG BRN			P2-21 P2-22		
		YEL BRN			P2-23 P2-24		
		GRN BRN			P2-25 P2-26		
		BLU BRN			P2-27 P2-28		
↓ TWP		VIO BRN	↓ P1	MASS	P2-29 P2-30	↓ 3	

*ZETACO*

TITLE

EXTERNAL "A" CABLE ASSEMBLY

**DOCUMENT NO.** 300-013-C0 thru 300-013-02

**SHEET 2 OF 3**

**REV. C**

# WIRE LIST

NOTES	WIRE GAUGE	COLOR	ORIGIN	TERM. METHOD	DESTINATION	TERM. METHOD	REMARKS
TWP ↑		GRY BRN	P1 ↑	MASS ↑	P2-31 P2-32	3 ↑	
		WHT BRN			P2-33 P2-34		
		ORG RED			P2-35 P2-36		
		YEL RED			P2-37 P2-38		
		GRN RED			P2-39 P2-40		
		BLU RED			P2-41 P2-42		
		VIO RED			P2-43 P2-44		
		GRY RED			P2-45 P2-46		
		WHT RED			P2-47 P2-48		
		YEL ORG			P2-49 P2-50		
		GRN ORG			P2-51 P2-52		
		BLU ORG			P2-53 P2-54		
		VIO ORG			P2-55 P2-56		
		GRY ORG			P2-57 P2-58		
↓ TWP		WHT ORG	↓ P1	↓ MASS	P2-59 P2-60	↓ 3	

*ZETACO*

TITLE

EXTERNAL "A" CABLE ASSEMBLY

**DOCUMENT NO.** 300-013-00 thru 300-013-02

**SHEET** 3 **OF** 3 **REV.** C

PARTS LIST  
ZETACO

FOR: INT DISK B FCC CABLE ASSY 18"

ASSEMBLY #: 300-014-00  
REV. LEVEL: E

ITEM	QTY	PART #	GENERIC DESCRIP.	DESCRIPTION	REFERENCE
----	---	-----	-----	-----	-----
1	1	025-030-00	CONN F	AMP 50S RECPT 205211-2	
2	26	029-010-00	CONN PIN F	AMP 66505-2	
3	1	030-043-00	CONN HDWE	D20418-2 HEX SET	
4	0	020-026-00	CABLE	RND CONDCT FL CA 26 POSN	
5	1	025-037-00	CONN F	3M 3399-6026	
6	1	030-032-00	CONN HDWE	3M 3490-2 PULL TAB	
7	1	099-010-00	LABEL	1/2" X 1 3/4" WHITE PAPER	
8	0	010-001-00	TAPE	3M 850 1"	
9	0	018-029-00	CABLE MATL	805036	

# WIRE LIST

NOTES	WIRE GAUGE	COLOR	ORIGIN	TERM. METHOD	DESTINATION	TERM. METHOD	REMARKS
	28 ↑	BLU GRY ↑	P1-1	5 ↑	P2-1	2 ↑	
			P1-2		P2-2		
			P1-3		P2-3		
			P1-4		P2-4		
			P1-5		P2-5		
			P1-6		P2-6		
			P1-7		P2-7		
			P1-8		P2-8		
			P1-9		P2-9		
			P1-10		P2-10		
			P1-11		P2-11		
			P1-12		P2-12		
			P1-13		P2-13		
			P1-14		P2-14		
			P1-15		P2-15		
			P1-16		P2-16		
			P1-17		P2-17		
			P1-18		P2-18		
			P1-19		P2-19		
			P1-20		P2-20		
			P1-21		P2-21		
			P1-22		P2-22		
			P1-23		P2-23		
			P1-24		P2-24		
	↓ 28	↓ GRY	P1-25	↓ 5	P2-25	↓ 2	
			P1-26		P2-26		

ZETACO

TITLE

INTERNAL DISK B FCC CABLE ASSEMBLY

DOCUMENT NO. 300-014-00 thru 300-014-03

SHEET 2 OF 2

REV. E



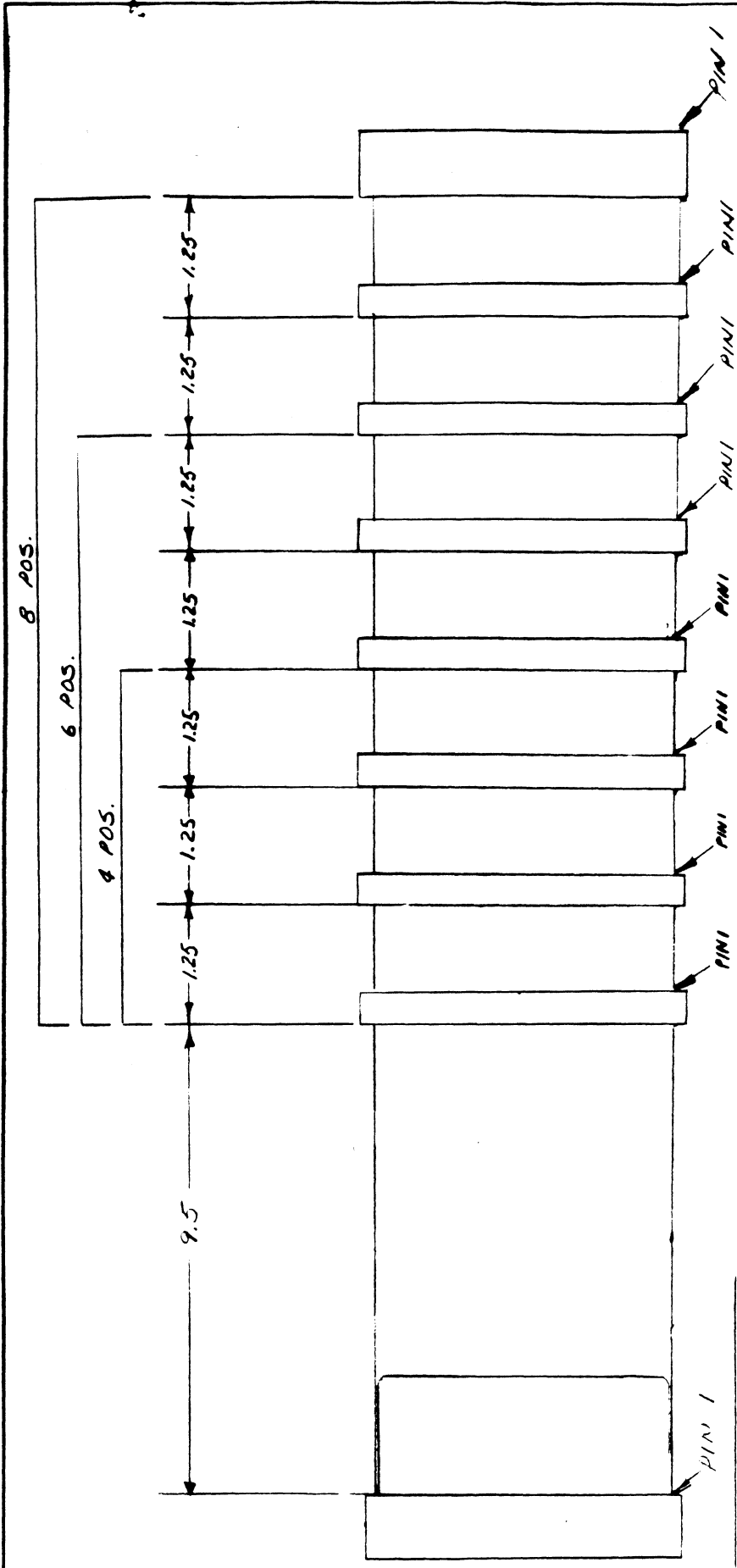

OPTION TABLE

PART NO	REV	OPTION
300-038-00	A	4 POSITION
300-038-01	A	6 POSITION
300-038-02	A	8 POSITION

REVISION HISTORY	
ECO #	DATE
0046	2-27-85
DESCRIPTION PER ECO	

© 1985	ZETACO
DESIGNED BY	
CHECKED BY	
APPROVED BY	
SCALE	
TITLE	BMX BUS CABLE Assy
	300-038-TAB

SHEET (1 OF 1)

CONTAIN CABLE WITH APPROPRIATE PART NUMBER & LENGTH

± 50 TOLLRANCE ON CABLE LENGTH

PARTS LIST  
ZETACO

FOR: BMX BUS CABLE ASSY 4 POSITION

ASSEMBLY #: 300-038-00  
REV. LEVEL: A

ITEM	QTY	PART #	GENERIC DESCRIP.	DESCRIPTION	REFERENCE
1	5	025-038-00	CONN F	3M 3417-6040	
2	5	030-033-00	CONN HDWE	3M 3490-4 PULL TAB	
3	0	020-015-00	CABLE	3M 3302/40 28 AWG	
4	1	099-010-00	LABEL	1/2" X 1 3/4" WHITE PAPER	
5	0	010-001-00	TAPE	3M 850 1"	

PARTS LIST  
ZETACO

OR: BMX-3 "A" PADDLEBOARD ASSEMBLY

ASSEMBLY #: 500-408-00  
REV. LEVEL: C

ITEM	QTY	PART #	GENERIC DESCRIP.	DESCRIPTION	REFERENCE
----	----	-----	-----	-----	-----
1	4	026-008-00	CONN M	HDR 26P 3M #3593-5002	
2	2	025-035-00	CONN F	BERG 67659-066 24S EDGE	
3	5	099-004-00	LABEL	5552 AVERY	PORT 0,1,2,3
4	1	041-087-00	PCB PADDLE	BMX-3 "A" REV B	
5	2	070-038-00	PCB HDWE	ARIES 6-680-190T HEADER	
6	2	070-039-00	PCB HDWE	ARIES 6-655-10 COVER	
7	1	025-036-00	CONN F	BERG 67659-078 52S EDGE	

PARTS LIST  
ZETACO

FOR: BMX-3 "B" PADDLEBOARD ASSEMBLY

ASSEMBLY #: 500-409-00  
REV. LEVEL: D

ITEM	QTY	PART #	GENERIC DESCRIP.	DESCRIPTION	REFERENCE
----	----	-----	-----	-----	-----
1	4	051-039-00	RES 470	1/4W 5%	R1,R2,R3,R4
2	1	026-002-00	CONN M	HDR 60P 3M #3372-5002	P1
3	2	099-004-00	LABEL	5552 AVERY	SMD A, ASSY #
4	3	065-007-00	SOC LO PRO	DILB 14P-108T	U2,U3,U4
5	1	065-000-00	SOC LO PRO	DILB 8P-108T	U1
6	1	070-018-00	PCB HDWE	ARIES 10-680-191T HEADER	U2
7	1	070-012-00	PCB HDWE	ARIES 24-680-190T HEADER	U1
8	1	070-013-00	PCB HDWE	ARIES 24-655-10 COVER	U1
9	1	041-088-00	PCB PADDLE	BMX-3 "B" REV B	
10	1	065-001-00	SOC LO PRO	DILB 16P-106T	U1
11	6	070-007-00	PCB HDWE	.025X.025 W/W 86090-4 PIN	
12	2	070-037-00	PCB HDWE	ARIES ML-100S JUMPER	W2,W4
13	1	070-011-00	PCB HDWE	ARIES 10-655-10 COVER	U2
14	1	099-014-00	LABEL	BISHOP A 100-L ARROW	U1
15	2	025-035-00	CONN F	BERG 67659-066 24S EDGE	
16	1	025-036-00	CONN F	BERG 67659-078 52S EDGE	

PIN 1 TO PIN 1

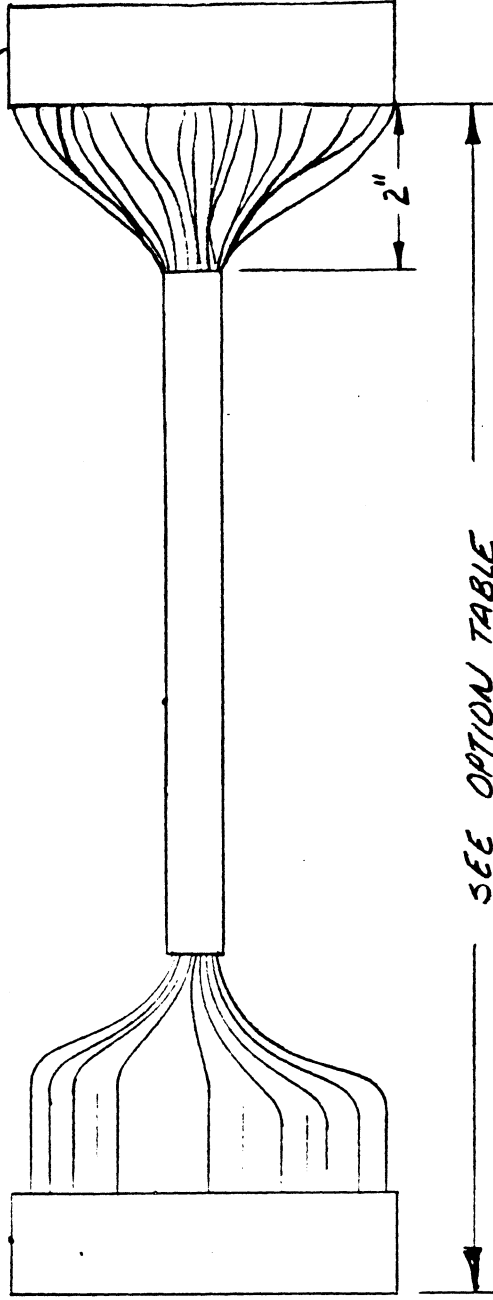

SEE OPTION TABLE

(SHEET 1 OF 2)

REVISION HISTORY	
ECO	DATE
0299	5/3/84
0445	2-7-85

DESCRIPTION	
PER ECO	ADD 10' LENGTH

© 1985 ZETACO

DRAWN BY	DATE	REVISIONS	DATE
PLUSETH	9-28-82		
CHECKED BY			
APPROVED BY			
SCALE:			

TITLE	DRAWING NUMBER
DAISY CHAIN "A" CABLE ASSY (FCC)	300-081-TAB

OPTION TABLE		
PART NO	REV	OPTION
300-081-00	A	6'
300-081-01	A	16'
300-081-02	A	10'

NOTE: STAMP CABLE WITH APPROPRIATE PART NUMBER AND LENGTH

100015 000

PARTS LIST  
ZETACO

FOR: DAISY CHAIN A CABLE ASSY FCC 6'

ASSEMBLY #: 300-081-00  
REV. LEVEL: A

ITEM	QTY	PART #	GENERIC DESCRIP.	DESCRIPTION	REFERENCE
1	2	025-041-00	CONN F	3M 3334-6060	
2	2	030-034-00	CONN HDWE	3M 3490-5 PULL TAB	
3	0	020-016-00	CABLE	REX T-7978-30PR, 28 AWG	
4	1	099-011-00	LABEL	SLSH-20375 BRADY RND CBL	





































; 5. ALL NUMBERS ENTERED IN 7.0 MUST BE IN OCTAL.  
; ANY NON-OCTAL INPUT IS TREATED AS A LETTER.  
; ANY LETTER INPUT FOR CYL, HEAD, SECTOR, OR # OF  
; SECTORS GETS RANDOM FUNCTION IN THE RELIABILITY  
; TEST WITH OPTIONS.

; 6. AT TIMES THE ECC MAY ATTEMPT TO CORRECT A NON-CORRECTABLE  
; DATA ERROR AND THE SIMULATED ECC AND ACTUAL ECC WILL  
; MATCH EVEN THOUGH AN ECC FAILURE WILL HAVE BEEN PRINTED.  
; THIS IS DUE TO A FAILURE OF THE ECC POLYNOMIAL ITSELF TO  
; DISTINGUISH BETWEEN TWO DIFFERENT ERROR PATTERNS; ONE  
; CORRECTABLE AND ONE UNCORRECTABLE. THIS IS NOT A  
; HARDWARE FAILURE.

; 13.0 PROGRAM RUNTIME:

; PROGRAM RUNTIMES ARE SUBSTANTIALLY REDUCED WITH  
; MEMORIES OF 16K OR LARGER. PROGRAM CAN USE UP TO  
; 24K USING 2 BUFFERS AND UP TO 32K USING 4 BUFFERS  
; IN THE RANDOM RELIABILITY TESTS. ## SEE 9D

; READ, WRITE AND SEEK OPERATIONS ARE TIMED  
; BY SPECIAL ROUTINES. WHEN THE PROGRAM IS  
; FIRST STARTED, THE TIMING ROUTINE WILL TEST  
; FOR THE PRESENCE OF A REAL TIME CLOCK (RTC)  
; TO DERIVE TIMING FROM IT.

; 1. ECC CORRECTED -THE ECC DETECTED AND SUCCESSFULLY  
CORRECTED THE DATA ERROR.

; 2. NON-CORRECTABLE ECC -THE ECC DETECTED AND CORRECTLY  
DIAGNOSED THE ERROR PATTERN AS UNCORRECTABLE.

; 3. ECC UNDETECTED -THE ECC FAILED TO DETECT A DATA ERROR.  
THIS MAY BE A MALFUNCTION OF THE ECC LOGIC; BUT IT IS  
MORE LIKELY ONE OF THE FOLLOWING PROBLEMS:

; A FAILURE OF THE DRIVE TO WRITE A SECTOR.  
\*\*\*NOTE- A CHECK SHOULD BE MADE IN THE BAD SECTOR  
LOG TO SEE WHETHER A WRITE OPERATION MAY HAVE  
ENCOUNTERED A SOFT OR FAULTY BAD SECTOR INDICATION,  
WHICH WOULD HAVE TERMINATED THE WRITE.

; A FAILURE IN THE CONTROLLER DATA PATHS.  
4. ECC FAILED -TWO CONDITIONS MAY FALL INTO THIS CATEGORY.

; 4A. AN ECC ERROR WAS DETECTED BUT WITH NO ACCOMPANYING  
DATA ERROR. A CHECK IS MADE TO SEE WHETHER THE ECC  
WORDS POINT TO AN ERROR WITHIN THE TWO APPENDED  
WRITE ECC WORDS. IF SUCH AN ERROR IS  
DETERMINED TO BE THE CASE, THE ERROR WILL BE LOGGED AS  
CORRECTABLE AND NO ECC FAILED MESSAGE WILL RESULT.  
THIS TYPE OF ERROR SHOULD REPRESENT ONLY A VERY SMALL  
PERCENTAGE OF THE DATA ERRORS (<1% - LARGE SAMPLE). IF  
A SIGNIFICANTLY HIGHER PERCENTAGE OF THIS ERROR RESULTS,  
THEN AN ECC PROBLEM WOULD BE INDICATED.

; IF THE ECC DOES NOT POINT TO THE TWO APPENDED WRITE ECC  
WORDS, THEN AN ECC FAILED MESSAGE (1ST PASS ONLY) WILL  
RESULT AND THE ACTUAL ECC WORDS READ FROM THE CONTROLLER  
WILL BE PRINTED.

; 4B. AN ECC ERROR WAS DETECTED, BUT THE ECC EITHER FAILED  
TO CORRECT A CORRECTABLE ERROR, OR TRIED TO CORRECT AN  
UNCORRECTABLE ERROR; THESE CONDITIONS (POSSIBLY CAUSED  
BY PROBLEMS OTHER THAN ECC) WILL RESULT IN A PRINTOUT  
(1ST PASS ONLY) OF THE SIMULATED WRITE AND SIMULATED  
READ ECC WORDS PLUS THE ACTUAL READ ECC WORDS AS READ  
FROM THE CONTROLLER.

; THE SIMULATED WRITE ECC WORDS ARE THE RESULT OF A  
PROGRAM SIMULATION OF THE ECC LOGIC ON WHAT THE PROGRAM  
BELIEVES TO BE THE WRITE DATA (A WRITE ERROR WILL CAUSE  
THIS ASSUMPTION TO BE FALSE), AND REPRESENTS WHAT THE  
PROGRAM BELIEVES SHOULD HAVE BEEN WRITTEN AS THE ACTUAL  
TWO WRITE ECC WORDS ON THE DISK.

; THE SIMULATED READ ECC WORDS ARE THE RESULT OF ANOTHER  
PROGRAM SIMULATION OF THE ECC LOGIC ON THE READ DATA  
IN MEMORY, AND REPRESENT WHAT THE PROGRAM BELIEVES  
SHOULD BE READ FROM THE CONTROLLER AS THE TWO ECC  
WORDS. THE ACTUAL READ ECC WORDS ARE THOSE TWO WORDS  
AS READ FROM THE DISK CONTROLLER.

;10.4 ERRORS- ERROR STATUS IS PRINTED WHENEVER ENCOUNTERED  
AS FOLLOWS:

; 'MODE' UNIT: 'N'  
; CYL- 'N' HEAD 'N' SECT 'N' #SECT 'N'  
; DIA/DIB STATUS= 'N' 'DESCRIPTIVE MESSAGE'



; CONSTANT. A 25. K PHYSICAL BLOCK WITH THE  
; START 1K DESIGNATED BY THE PROGRAM VARIABLE MPB?N  
; WILL BE ALLOCATED TO THE DISK I/O BUFFER AS FOLLOWS:

; THE 25K I/O BUFFER IS DIVIDED INTO 3 NON-CONTIGUOUS  
; BUFFERS, 9K OF COMMON (TO BOTH THE A AND B I/O BLOCKS)  
; WRITE BUFFER (WAB), 8K OF READ BUFFER ALLOCATED TO THE  
; A-I/O BLOCK (RA) VIA THE A USER MAP, AND 8K  
; OF READ BUFFER ALLOCATED TO THE B-I/O BLOCK (RB) VIA  
; THE B USER MAP. THE 1K BLOCKS OF THE 3 BUFFERS ARE  
; INTERLEAVED IN THE PHYSICAL SPACE IN THE FOLLOWING  
; MANNER:

; WAB1, RA1, RB1, WAB2, RA2, RB2, WAB3 ETC.

; 4.2 THE 25K PHYSICAL I/O BUFFER IS MAPPED TO THE  
; 1ST 25K LOGICAL IN THE DCH MAP. DISPLACEMENT VALUES  
; H:DBW, 2 AND H:DBR, 2 ARE ADDED TO THE USER LOGICAL  
; ADDRESSES WHEN LOADING THE DCH MEMORY ADDRESS REGISTER.

; 10.0 PROGRAM OUTPUT/ERROR DESCRIPTION:

; ALL ERRORS ARE IDENTIFIED, COUNTED, AND THE  
; PROGRAM IS ROUTED VIA BASE TO A CALL TO CKSW.  
; ON THE BASIS OF SWITCH SETTINGS (SEE 8.2) THE  
; PROGRAM WILL GO INTO A SCOPE LOOP, OR PROCEED,  
; DEPENDING ON THE SWPAK SETTINGS.

; UPON LOSS OF READY AND A SINGLE DRIVE, THE PROGRAM  
; WILL PRINT THE APPROPRIATE ERROR MESSAGE AND WILL NOT  
; PROCEED UNTIL READY IS RETURNED. IF MULTIPLE  
; DRIVES EXIST, THE PROGRAM WILL CONTINUE WITH THE  
; REMAINING DRIVES. IF THE DOWN DRIVE IS PLACED BACK  
; ONLINE, THE PROGRAM WILL RESUME TESTING OF  
; THAT DRIVE. THE ABOVE ALSO APPLIES TO THE LOSS  
; OF WRITE ENABLE IF THE PROGRAM IS IN A WRITE MODE.

; RECALIBRATE - ANY UNUSUAL STATUS IS REPORTED  
; IMMEDIATELY AND AN ERROR RETURN EXECUTED.

; 10.1 SEEK - POSITIONER FAULT STATUS INCREMENTS SEEK  
; ERROR COUNTER. ANY ERROR STATUS RESULTS  
; IN STATUS PRINTOUT AND ERROR RETURN.  
; A RECALIBRATE WILL BE PERFORMED BY THE ERROR HANDLER.  
; PROGRAM WILL LOG THE FIRST 20. CYLINDERS  
; TO/FROM ON FINDING SEEK ERRORS

; 10.2 WRITE - FOLLOWING "DONE" ON A WRITE, ERRORS ARE  
; CHECKED IN THE SEQUENCE SHOWN BELOW. ERROR  
; RECOVERY PROCEEDURE IS OUTLINED FOR EACH CASE.  
; IF THE ERROR IS NOT PRESENT THE NEXT CHECK IS MADE.

; DRIVE STATUS (DIB) IS CHECKED 1ST FOR BOTH READ AND  
; WRITE BEFORE ANY DIA CHECKS ARE MADE

; 1. READ/WRITE TIMEOUTS, DATA LATE, ILLEGAL SECTOR,  
; PARITY, DATA VERIFY, OR ANY DRIVE FAULTS- INCREMENT THE  
; APPROPRIATE ERROR COUNT, PRINT THE ILLEGAL STATUS  
; AND DO AN ERROR RETURN. ANY DRIVE FAULT WILL CAUSE  
; A RECALIBRATE TO BE PERFORMED BY THE ERROR HANDLER.

; 2. ADDRESS ERROR- REPEAT THE WRITE, IF TEST PASSES

DIFFERENT BITS AND THEIR INTERPRETATION AT LOCATION  
"SWREG" IS AS FOLLOWS:

BIT	OCTAL VALUE	BINARY VALUE	INTERPRETATION
1	40000	0 1	LOOP ON ERROR SKIP LOOPING ON ERROR
2	20000	0 1	PRINT TO CONSOLE ABORT PRINT OUT TO CONSOLE
4	04000	0 1	PRINT PASS DO NOT PRINT PASS
5	02000	0 1	DO NOT PRINT ON THE LINE PRINTER PRINT ON THE LINE PRINTER
6	01000	0 1	DO NOT EXIT TO ODT ON ERROR EXIT TO ODT ON ERROR
7	00400	0 1	**** N/A BREAK FOR PACK INTERCHANGE
8	00200	0 1	**** N/A FOR READ ONLY MODE (SA 501,502)
9	00100	0 1	N/A BYPASS DATA CHECK
10(A)	00040	0 1	N/A DO VERIFY AFTER WRITE (SA 502 ONLY AND NOT RANDOM DATA)
11(B)	00020	0 1	N/A ENABLE BAD SECTOR PRINTOUTS
12(C)	00010	0 1	N/A HALT ON DRIVE ERROR PRIOR TO RECOVERY RECALIBRATE OPERATION
13(D)	00004	0 1	NO TRACE TRACE PRINTOUT ON ERROR

;9.0 OPERATING PROCEEDURE/OPERATOR INPUT:

- A. VERIFY DRIVE (DRIVES) ARE READY ON-LINE
- B. LOAD PROGRAM USING BINARY LOADER
- C. TO RUN OTHER THAN TEST 505, ENTER CONTROL "0"  
AT 9.2, ENTER STARTING ADDRESS FOLLOWED BY AN "R"

; STARTING ADDRESS

200	READ UNIT CHARACTERISTICS AND THEN RUN ALL TEST (505)
500	RELIABILITY TEST; ALL CYLINDERS
501	RELIABILITY TEST, (OPTIONS)
502	INCREMENTAL DISK ADDRESS TEST
503	COMMAND STRING INTERPRETER
504	QUICKIE FORMATTER
505	RUN ALL
506	SEEK EXERCISER (CONVERGING, DIVERGING PATTERN)
507	SEEK EXERCISER (RANDOM PATTERN)
510	ERROR COUNT/LOG RECOVERY

;9.1 OPERATOR IS REQUESTED TO ENTER DEVICE CODE OF

; SECTORS GETS RANDOM FUNCTION IN THE RELIABILITY  
; TEST WITH OPTIONS.

; D. COMMAND STRING INTERPRETER (SA 503)  
; AS A TROUBLE SHOOTING AID THE SERVICE  
; ENGINEER MAY TYPE IN HIS OWN TEST LOOP.  
; AFTER STARTING AT 503, THREE ARGUMENTS  
; MUST BE ENTERED IN RESPONSE TO THREE  
; PROGRAM QUESTIONS; "UNIT", "DATA", AND  
; "COMMAND STRING". ALL NUMBERS MUST ENTERED  
; IN OCTAL.

; I. UNIT: TYPE UNIT # OR CARRIAGE TO  
; USE THE PREVIOUS ENTRY

; II. DATA: RAN=RANDOM

; ALO=ALL ONES  
; ALZ=ALL ZEROS  
; PAT=155555 PATTERN  
; ROT=155555 PATTERN ROTATED ON  
; SUCCESSIVE PASSES.  
; ALT=52525 PATTERN  
; FLO=FLOATING ONE PATTERN  
; FLZ=FLOATING ZERO PATTERN  
; ADR=ALTERNATING CYLINDER AND  
; HEAD, SECTOR WORDS  
; VAR=EXISTING WORDS ENTERED PREVIOUSLY AS  
; DESCRIBED BELOW

; ALTERNATIVELY ENTER A STRING OF UP TO 7  
; OCTAL 16 BIT WORDS TO BE  
; USED AS DATA. THE WORDS  
; ENTERED ARE USED REPEATEDLY  
; TO MAKE UP A SECTOR BLOCK.  
; TYPE CARRIAGE TO USE THE  
; PREVIOUS ENTRY:

; III. COMMAND STRING:

; OPTIONS 1. READ HEAD, SECTOR, #SECTORS  
; 2. WRITE SAME  
; 3. SEEK CYLINDER  
; 4. RECALIBRATE  
; 5. LOOP (GO TO BEGINNING OR LR)  
; 6. DELAY N (N= DELAY IN MS)  
; 7. DISABLE (WRITE DISABLE)  
; 8. TRESPASS  
; 9. STOP DISK  
; 10. RELEASE  
; 11. OFF (OFFSET FORWARD)  
; 12. OFR (OFFSET REVERSE)  
; 13. LR (BEGIN LOOP HERE)  
; 14. VERIFY (WRITE)  
; 15. MEMORY ADDR; DATA (WRITE) (CONTROLLER MEMORY COMMAND)  
; 16. TYPE CARRIAGE RETURN TO USE THE  
; PREVIOUS COMMAND STRING.

; NOTE THAT EITHER SPACES OR A COMMA  
; MAY BE USED AS AN ARGUMENT DELIMITER.  
; EACH RESPONSE IS TERMINATED BY  
; TYPING CARRIAGE RETURN. IF MORE  
; ROOM IS NEEDED ON A LINE, TYPE  
; LINE FEED TO SPACE TO THE NEXT LINE.

\*\*\*\*\*

DESCRIPTION: ZETACO SMD DISK CONTROLLER RELIABILITY PROGRAM

Product of ZETACO, 1984

\*\*\*\*\*

TITLE DISKR

.DUSR X=1

.NOMAC X

;1.0 PROGRAM NAME: DISKR.SR

;2.0 REVISION HISTORY:

REV.	DATE	
00	02/09/83	
01	09/07/83	;S120 # SKP TOGETHER, STACK AND ;AOS BOOTSTRAP AT 400, NO VERIFY ;WITH RANDOM DATA TEST 502 SWT 10
02	03/28/84	;ADD RELEASE COMMAND TO RC ;FOR DUAL PORT, DAISY CHAIN ;DISK SECTOR PULSE COUNTER ;DEVICE CODE CHANGE ROUTINE ;502 PAT 24 SECTOR ;ZDF1,
03	05/30/84	
04	08/21/85	;DISABLE VIRTUAL, UP TO 2048. ;CYLS, 40 HDS

;3.0 MACHINE REQUIREMENTS:

NOVA/ECLIPSE FAMILY CENTRAL PROCESSOR  
 16K READ/WRITE MEMORY  
 TELETYPE OR CRT DISPLAY  
 ZETACO SMD DISK CONTROLLER  
 0-3 DISK DRIVES

;4.0 TEST REQUIREMENTS: N/A

;5.0 SUMMARY:

THE ZETACO DISK CONTROLLER RELIABILITY PROGRAM IS A MAINTENANCE PROGRAM DESIGNED TO EXERCISE AND TEST THE ZETACO SMD DISK SUB-SYSTEMS AND 1-4 DISK DRIVES. THE DISK DRIVES MAY BE SHARED BETWEEN TWO COMPUTERS IN WHICH CASE THE FOLLOWING PROGRAMS MAY BE RUNNING IN EACH COMPUTER:

STARTING ADRESSES'S (SA) 500,501 RANDOM RELIABILITY  
 SA 503 COMMAND STRING (IF A RELEASE COMMAND IS INCLUDED IN THE COMMAND STRING)

THE CONTROL CAN BE ANY DEVICE CODE 20-76 OCTAL.  
 THE DEFAULT IS 27 -SEE 9.1 FOR OTHER SETTINGS

;6.0 RESTRICTIONS:

1. THE DISK DRIVES MAY BE

; OPERATOR INPUT CONTROLLED PRINTOUTS ARE AS FOLLOWS:

; L = FIRST 200. BAD SECTORS, DATA, OR ADDRESSES  
; ALSO LISTED IS A COUNT FOR CONTROLLER  
; CORRECTS/UNIT (ON BOARD ECC CORRECTION AND OFFSET CORRECTS)

;10.0 PROGRAM OUTPUT/ERROR DESCRIPTION:

; 1. ERRORS- ERROR STATUS IS PRINTED  
; WHENEVER ENCOUNTERED. WHEN DATA ERRORS  
; ARE FOUND ONLY THREE ARE PRINTED PER  
; ENCOUNTER. (SEE PARAGRAPH 10.3)

; 2. IF ERRORS ARE ENCOUNTERED MORE THAN ONCE,  
; A COUNT WILL BE RECORDED AND A BAD SECTOR FLAG SET.  
; ALL ADDRESS INFO. WILL BE PRINTED IN OCTAL.

; 3. ERROR REPORTING AND RECOVERY

; ALL ERRORS ARE IDENTIFIED, AND THE  
; PROGRAM IS ROUTED VIA BASE TO A CALL TO CKSW.  
; WITH THE EXCEPTION OF ADDRESS AND DATA ERRORS  
; THE PROGRAM WILL THEN LOOP FOR OPERATOR INTERVENTION,  
; ON THE BASIS OF SWPAK (SEE 8.)

; RECALIBRATE - ANY UNUSUAL STATUS IS REPORTED  
; IMMEDIATELY AND AN ERROR RETURN EXECUTED.

; SEEK - POSITIONER FAULT STATUS RESULTS  
; IN STATUS PRINTOUT AND ERROR RETURN.

; WRITE - FOLLOWING "DONE" ON A WRITE, ERRORS ARE  
; CHECKED IN THE SEQUENCE SHOWN BELOW. ERROR  
; RECOVERY PROCEDURE IS OUTLINED FOR EACH CASE.  
; IF THE ERROR IS NOT PRESENT THE NEXT CHECK IS MADE.

; DRIVE STATUS (DIB) IS CHECKED 1ST FOR BOTH READ AND  
; WRITE BEFORE ANY DIA CHECKS ARE MADE

; 4. READ/WRITE TIMEOUTS, DATA LATE, ILLEGAL SECTOR,  
; ECC(DATA OK), OR ANY DRIVE FAULT- PRINT THE ILLEGAL  
; STATUS AND DO AN ERROR RETURN.

; 5. ADDRESS ERROR- REPEAT THE WRITE, IF TEST PASSES  
; THE SECOND TIME, DO A NORMAL RETURN; OTHERWISE  
; FLAG AS HARD, SET THE BAD SECTOR FLAG FOR THAT SECTOR  
; AND DO AN ERROR RETURN.

; IF A HARD CYLINDER ADDRESS ERROR OCCURS, A READ  
; ON AN ADJACENT HEAD WILL BE ATTEMPTED TO DETERMINE  
; WHETHER THE FAULT SHOULD BE CLASSED AS A SEEK ERROR  
; OR AN ADDRESS ERROR. THE FIRST 30. HARD ADDRESS  
; ERRORS WILL HAVE THEIR ADDRESSES LOGGED.

; 6. ENDING MEMORY ADDRESS -PRINT THE ERROR MESSAGE,  
; CHECK FOR A DISK ADDRESS AND DO AN ERROR RETURN.

; 7. ENDING DISK ADDRESS -PRINT THE ERROR MESSAGE AND  
; DO AN ERROR RETURN.

; READ - ALL READ ERRORS WITH THE EXCEPTION OF DATA RELATED  
; ERRORS ARE HANDLED THE SAME AS DESCRIBED FOR THE WRITE  
; OPERATIONS

HEAD, SECTOR WORDS  
VAR=EXISTING WORDS ENTERED PREVIOUSLY AS  
DESCRIBED BELOW

ALTERNATIVELY ENTER A STRING OF UP TO 7  
OCTAL 16 BIT WORDS TO BE  
USED AS DATA. THE WORDS  
ENTERED ARE USED REPEATEDLY  
TO MAKE UP A SECTOR BLOCK.  
TYPE CARRIAGE TO USE THE  
PREVIOUS ENTRY:

III. COMMAND STRING:

OPTIONS 1. READ HEAD, SECTOR, #SECTORS  
2. WRITE SAME  
3. SEEK CYLINDER  
4. RECALIBRATE  
5. LOOP (GO TO BEGINNING OR LR)  
6. DELAY N (N=DELAY IN MS)  
7. DISABLE (WRITE DISABLE)  
8. TRESPASS  
9. STOP DISK  
10. RELEASE  
11. OFF (OFFSET FORWARD)  
12. OFR (OFFSET REVERSE)  
13. LR (BEGIN LOOP HERE)  
14. VERIFY (WRITE)  
15. FORMAT CYL, HD, SECTOR  
16. BAD (BAD SECTOR) CYL, HD, SECTOR  
17. MEMORY ADDR, DATA(WRITE) (CONTROLLER MEMORY COMMAND)  
18. TYPE CARRIAGE RETURN TO USE THE  
PREVIOUS COMMAND STRING.

NOTE THAT EITHER SPACES OR A COMMA  
MAY BE USED AS AN ARGUMENT DELIMITER.  
EACH RESPONSE IS TERMINATED BY  
TYPING CARRIAGE RETURN. IF MORE  
ROOM IS NEEDED ON A LINE, TYPE  
LINE FEED TO SPACE TO THE NEXT LINE.  
THE WORD "SAME" USED WITH READ, OR WRITE,  
WILL CAUSE THE PREVIOUS DISK  
ADDRESS PARAMETERS TO BE USED.

AN R TYPED WHILE A STRING IS BEING EXECUTED WILL  
CAUSE THE PROGRAM TO RETURN TO COMMAND STRING START.  
THE ESCAPE KEY WILL BYPASS UNIT AND DATA PROMPTS TO  
THE COMMAND STRING PROMPT.

THE FOLLOWING EXAMPLE WOULD CAUSE UNIT  
1 TO SEEK CYLINDER 50, THEN REPEATEDLY  
WRITE SECTORS 2 AND 3 OF HEAD 5,  
THEN READ IT BACK AND CHECK. DATA IS SPECIFIED  
AS ALTERNATE WORDS OF ZEROS THEN ONES.

UNIT: 1  
DATA: 0,177777  
COMMAND STRING: SEEK 50 LR WRITE 5,2,2 READ SAME LOOP

THE FOLLOWING EXAMPLE WOULD WRITE ZERO TO  
CONTROLLER MEMORY LOCATION 1500 (OCTAL)

UNIT: 1  
DATA: N/A

\*\*\*\*\*

; DESCRIPTION: ZETACO SMD DISK CONTROLLER FORMATTER PROGRAM

; Product of ZETACO, 1985

\*\*\*\*\*

.....:TITLE DISKF.....  
;1.0 .DUSR X=1  
.NOMAC X  
PROGRAM NAME: DISKF.SR

;2.0 REVISION HISTORY:

; REV. DATE ;  
; 00 02/09/83 ;  
; 01 08/23/83 ;ADUB FOR ALT1 (STTD), AOS BSTRAP (400'S)  
; 02 03/28/84 ;DISK PULSE COUNTER, ERROR LOGS, 200.  
; ;ERRORS, MSB FOR BAD SECTOR LOG  
; ;DEVICE CODE CHANGE ROUTINE  
; 03 05/30/84 ;ECC ON WRITE, ZDF1  
; ;  
; 04 08/21/85 ;DISABLE VIRTUAL, UP TO 2048. CYLS  
;

;3.0 MACHINE REQUIREMENTS:

; NOVA/ECLIPSE FAMILY CENTRAL PROCESSOR  
; 16K READ/WRITE MEMORY  
; TELETYPE OR CRT DISPLAY  
; ZETACO SMD DISK CONTROLLER  
; 0-3 DISK DRIVES

;4.0 TEST REQUIREMENTS: N/A

;5.0 SUMMARY:

; THE ZETACO SMD DISK CONTROLLER FORMATTER  
; PROGRAM IS A PROGRAM DESIGNED TO FORMAT AND  
; CHECK DISK PACKS TO BE USED ON DISK SYSTEMS.  
; THE PROGRAM IS NOT A MAINTENANCE PROGRAM  
; AND ASSUMES THE HARDWARE TO BE IN WORKING ORDER.  
; THE PROGRAM WILL HALT ON ANY NON-DATA RELATED  
; ERRORS. ALTHOUGH PRESSING CONTINUE WILL ALLOW  
; THE PROGRAM TO PROCEED, IT IS NOT RECOMMENDED  
; THAT THE PROGRAM BE RUN UNDER THESE CONDITIONS.  
; IT IS ALSO RECOMMENDED THAT ON-BOARD ECC BE  
; SOFTWARE OR CONFIGURED DISABLED WHEN FORMATTING.

; THE CONTROL CAN BE ANY DEVICE 20-76 OCTAL  
; THE DEFAULT IS 27 ## SEE 9.

;6.0 RESTRICTIONS: N/A

;7.0 PROGRAM DESCRIPTION/THEORY OF OPERATION:

; A. FORMATTER PROGRAM (STARTING ADDRESS <SA> 500)  
; THE DISK IS FIRST FORMATTED AFTER WHICH A FORMAT  
; DONE MESSAGE IS PRINTED. THEN A 55555 PATTERN

PROGRAM CONTROL TO GO TO ODT (NOTE: THIS IS AN  
OPTIONAL COMMAND AND IS AVAILBLE ONLY IF  
ODTPK IS PRESENT)

M THIS COMMAND GIVEN AT ANY TIME WILL PRINT THE  
CURRENT OPERATING MODES.

O THIS COMMAND GIVEN AT ANY TIME WILL LOCK THE  
PROGRAM INTO SWITCH MODIFICATION MODE WHERE  
MORE THAN 1 BIT CAN BE CHANGED.

## 9.0 OPERATING PROCEEDURE/OPERATOR INPUT:

9.1 LOAD USING THE BINARY LOADER

9.2 STARTING ADDRESSES

200-TO IDENTIFY DISK TYPE (INITIALIZE)  
PROGRAM THEN PROCEEDS TO 500.

201-ODT DIRECT ENTRY ONLY

202-RANDOM SEEK EXERCISERS. (1 PASS OF DIAG FOR EACH UNIT FIRST)  
SEEK EXER 1 IS A SINGLE DRIVE EXERCISER

SEEK EXER 2 IS TWO DRIVE EXERCISER WITH SEEK OVERLAP

500-DIAGNOSTIC (RESTART)

9.3 THE PROGRAM PRINTS "PASS" FOLLOWING EACH  
COMPLETE PASS THROUGH THE TESTS. RANDOM  
SEEK EXERCISER PERFORMS 1000 SEEKS  
PER "PASS" MESSAGE.

9.4 DEVICE CODE OF CONTROLLER IS REQUESTED (27 IS DEFAULT)

9.5 UNIT NUMBERS TO BE TESTED ARE REQUESTED TO WHICH THE OPERATOR  
ENTERS THE UNIT NUMBERS TO BE TESTED; SEPARATING  
THE INDIVIDUAL #'S BY A <,> OR <SPACE>.

9.6 OPERATOR IS REQUESTED TO ENTER 1, IF UNIT CHARACTERISTICS  
DISPLAYED ARE INCORRECT, AND WANTS TO LOOP ON READING THEM

## 10. PROGRAM OUTPUT/ERROR DESCRIPTION:

WHEN AN ERROR IS DETECTED THE PROGRAM PRINTS THE ERROR  
PC, AC'S 0,1,AND 2 AT THE POINT OF ERROR, THE PROGRAM THEN  
GOES INTO A SCOPE LOOP BETWEEN THE ENTRIES TO  
.SETUP AND .LOOP ALLOWING THE OPERATOR TO SET SWPAK.  
IN GENERAL THE ERROR PC WILL POINT TO A CALL ERROR.

THE PRINTOUT WILL BE OF ONE OF THE FOLLOWING FORMATS:

A. STANDALONE CONTROLLER TEST FAILURES-

B. STATUS ERRORS

MODE	UNIT	#	DATA
CYL	#	HEAD	# SECTOR #
AC1(STATUS) SHOULD =AC0			
DESCRIPTIONS OF FAILING STATUS BITS			

C. MEMORY/DISK ADDRESS ERROR

MODE	UNIT	#	DATA
CYL	#	HEAD	# SECTOR #
ENDING MEMORY/DISK ADDRESS ERROR			
AC1(MA/DA) SHOULD =AC0			



- INTERRUPT DISABLE, INTA LOGIC
- THAT SEEKS TO CYL'S 0, 1/2 CYL MAX, AND CYL MAX CAN AT LEAST BE EXECUTED AND SET DRIVE BUSY.
- READY/SELECT LOGIC

### 7.3 "C" TESTS CHECK:

- THAT THE CA REGISTER INCREMENTS PROPERLY VIA DCH OR BMC REQUESTS
- THAT A WRITE CAN BE EXECUTED
- SELD, CLEAR LOGIC
- THAT SEEK/WRITE OPERATIONS CAN BE EXECUTED
- WRITES TO DIFFERENT HDS, SECTORS
- MULTI-SECTOR WRITES
- THE INCREMENT HEAD LOGIC
- ILLEGAL SECTOR, SURFACE, CYLINDER CONDITIONS

### 7.4 "E" TESTS CHECK:

- THAT A READ MAY BE EXECUTED
- 8 SECTOR WRITE/READ OPERATIONS (9 DIFFERENT DATA PATTERNS) AT CYL'S 0, 1/2 CYL MAX AND CYL MAX WITH FULL CORE COMPARE
- DATA VERIFY FUNCTION (NORMAL AND WITH FORCED ERRORS)
- OFFSET MODES
- ILLEGAL COMMAND TRAPS
- WRITE CYL# TO HEAD 0, SECTOR 0 OF ALL CYLINDERS
- WRITE HEAD # TO SECTOR 0 OF ALL HEADS ON CYL 0
- WRITE SECTOR # TO ALL SECTORS OF HEAD 0, CYL 0
- EACH OF THE ABOVE OPERATIONS IS FOLLOWED BY A CORRESPONDING READ/CHECK OPERATION TO VERIFY DISK ADDRESSING LOGIC.

### 7.5 "F" TESTS CHECK:

THE FORMAT LOGIC ON CYL 0, HEAD 0, SECTOR 0, A BAD SET FLAG IS SET AND TESTED THE FORMAT IS SET TO NORMAL AFTER COMPLETION OF THESE TESTS.  
## SEE SWPAK 7 OPTION ##

### 7.6 "S" TESTS ARE SEEK EXERCISERS

- PERFORMS RANDOM SEEKING. EACH SEEK IS FOLLOWED BY A READ TO HEAD 0, SECTOR 0
- PERFORMS RANDOM OVERLAPPED SEEKING TO TWO DRIVES. EACH SEEK IS FOLLOWED BY A READ TO HEAD 0, SECTOR 0. U1 IS THE THE PRIMARY UNIT UNDER TEST AND U2 IS THE NEXT DRIVE FOUND IN A 1,2,3,0 ETC. SEARCH. IF ONLY 1 DRIVE, TEST IS BYPASSED. TEST IS ONLY RUN AFTER A PASS IS ACHIEVED ON ALL DRIVES:

## 8.0 OPERATING MODES/SWITCH SETTINGS:

### 8.1 SWITCH SETTINGS

LOCATION "SWREG" IS USED TO SELECT THE PROGRAM OPTIONS THIS LOCATION WILL BE SET ACCORDING TO THE ANSWERS SUPPLIED BY THE OPERATOR; THE OPTIONS CAN BE CHANGED OR VERIFIED BY USING ONE OF THE COMMANDS GIVEN IN SEC. 8.3