

# **Model 911E**

## **Emulating CRT Controller**

Copyright 1984.

All rights reserved.  
No material herein may be reprinted,  
copied or otherwise reproduced  
without permission from ZETACO.



REVISION HISTORY		
ECO #	DATE	DESCRIPTION
0222	11/7/83	Added Addendum, Changed Pages 2-1, 2-3
0235	12/7/83	Changed Pages 2-5, 2-6
0269	3/15/84	Changed Pages A5, B5, B6
0312	5/22/84	Changed Pages 2-5, 2-6, 2-7
0328	6/28/84	New ZETACO Cover
0394	10/2/84	See ECO



## TABLE OF CONTENTS

- 1.0 INTRODUCTION
  - 1.1 911-E General Description
  - 1.2 Specifications
  
- 2.0 CONTROLLER PREPARATION
  - 2.1 Overview
  - 2.2 CRU Address - Primary Channels
  - 2.3 CRU Address - Auxiliary Channels
  - 2.4 Interrupts
  - 2.5 Baud Rate
  - 2.6 EIA/Current Loop
  - 2.7 Echo/Run
  - 2.8 Burst/Normal
  - 2.9 Buffered Fl
  
- 3.0 TERMINAL PREPARATION AND INTERFACE
  - 3.1 Switch Settings
  - 3.2 Cables
  
- 4.0 SYSTEM GENERATION
  - 4.1 Overview
  - 4.2 Example

5.0       INSTALLATION AND CHECKOUT

- 5.1       Overview
- 5.2       Self-Test Flash Codes
- 5.3       Echo-Back
- 5.4       Online Diagnostics
- 5.5       Customer Service Information

6.0       OPERATION

- 6.1       911 Versus 911-E
- 6.2       Speed Considerations
- 6.3       Indicators
- 6.4       Burst Mode

APPENDIX A - National Computer Systems (NCS) 911E Application Information

APPENDIX B - Televideo 950 Application Information

APPENDIX C - Texas Instruments 931 Application Information

APPENDIX D - Adds Viewpoint Adds Regent 25 Application Information

## LIST OF FIGURES

- 2.1 911-E CONTROLLER
- 2.2 AUXILIARY CHANNEL ADDRESS SELECTOR
- 2.3 CHANNEL CONFIGURATION SELECTOR (ANY CHANNEL)
- 3.1 CONNECTOR PINOUT (BOARD EDGE VIEW)
- 5.1 ERROR FLASH CODES





## 1.0 INTRODUCTION

### 1.1 911-E GENERAL DESCRIPTION

The CSI Model 911-E is a four-channel communications controller designed to emulate the functional characteristics of the Texas Instruments 911 Video Display controller. This device occupies one full slot of any 990/X minicomputer and interfaces to the CRU bus. The 911-E is designed to operate in any UNMODIFIED TXDS, DX10 or DNOS system employing the standard 911 DSR. The controller can directly replace four existing 911 devices or provide up to four additional 911-like terminals per chassis slot.

### 1.2 SPECIFICATIONS

#### Mechanical

Size: 10.8 inch (27.4 cm) x 14.25 inch (36.2 cm)

Temperature Range: 0 - 55 C

Humidity: 0 - 90% (non-condensing)

#### Electrical

Power Requirements (from chassis):

+ 5 VDC @ 2.7	AMPS
+12 VDC @ 0.12	AMPS
-12 VDC @ 0.025	AMPS (EIA)
-12 VDC @ 0.105	AMPS (20 MA C.L.)

Communications (any channel)

Format: RS232-C

Mode: EIA or 20 MA current loop

Rate: 300 to 38400 BPS

Signals: Data Out, Data In, Clear to Send, Ground,  
20 MA Return

Connect: 9 Pin "D" Subminiature

## 2.0 CONTROLLER PREPARATION

### 2.1 OVERVIEW

Figure 2.1 shows the location of the on-board selectors. One bank is used to select the CRU base address for the two auxiliary channels. The remaining banks define the communication characteristics for each channel.

### 2.2 CRU ADDRESS - PRIMARY CHANNELS

The CRU addresses for the "A" and "B" channels are determined by the slot in which the 911-E is installed.

For example, if Slot-9 of a 13-slot main chassis is used, then Channel "A" will be >0100 and Channel "B" will be >0120.

### 2.3 CRU ADDRESS - AUXILIARY CHANNELS

Locate the "AUX ADDRESS" switch bank and refer to Figure 2.2. This switch determines the CRU addresses for the "C" and "D" channels.

\*\*\* READ THIS CAREFULLY \*\*\*

Choose an address that is NOT physically present in your system, including main and all expansion chassis. The top section of Figure 2.2 represents presently used addresses. The main chassis uses 000 to 17F (hexadecimal). If you have a main chassis only, you must choose an address of 200 or above. If your system contains a main and an expansion chassis, set the address at 400 or above.

The sample shown in Figure 2.2 (010000) represents address 400. If we were to choose address 440 (010001) switch 7 (in addition to switch 3 and 8) would be turned OFF (1). Determine the address you will use and enter the number in the space provided in Figure 2.2. Use an address which ends in 00, 40 or 80. For example; 300, 340, 380, 400, 440, 480, 500, etc.

Address 300 is represented by switch 4, 5 and 8 OFF.

Address 500 by switching 3, 5 and 8 OFF.

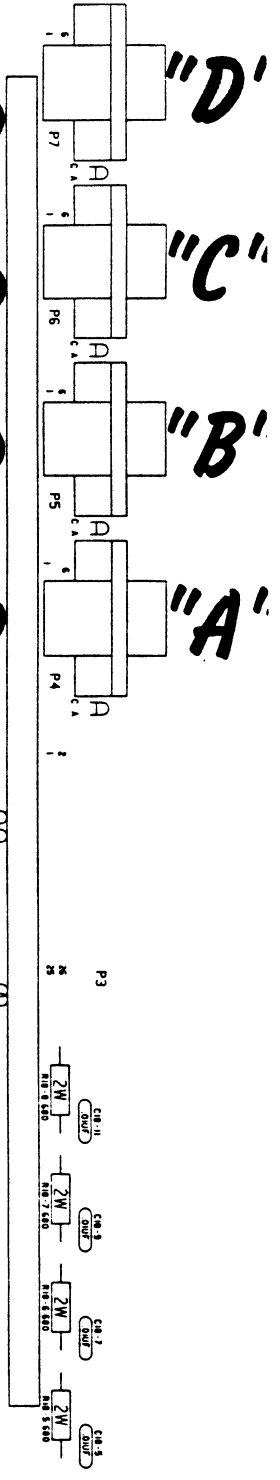
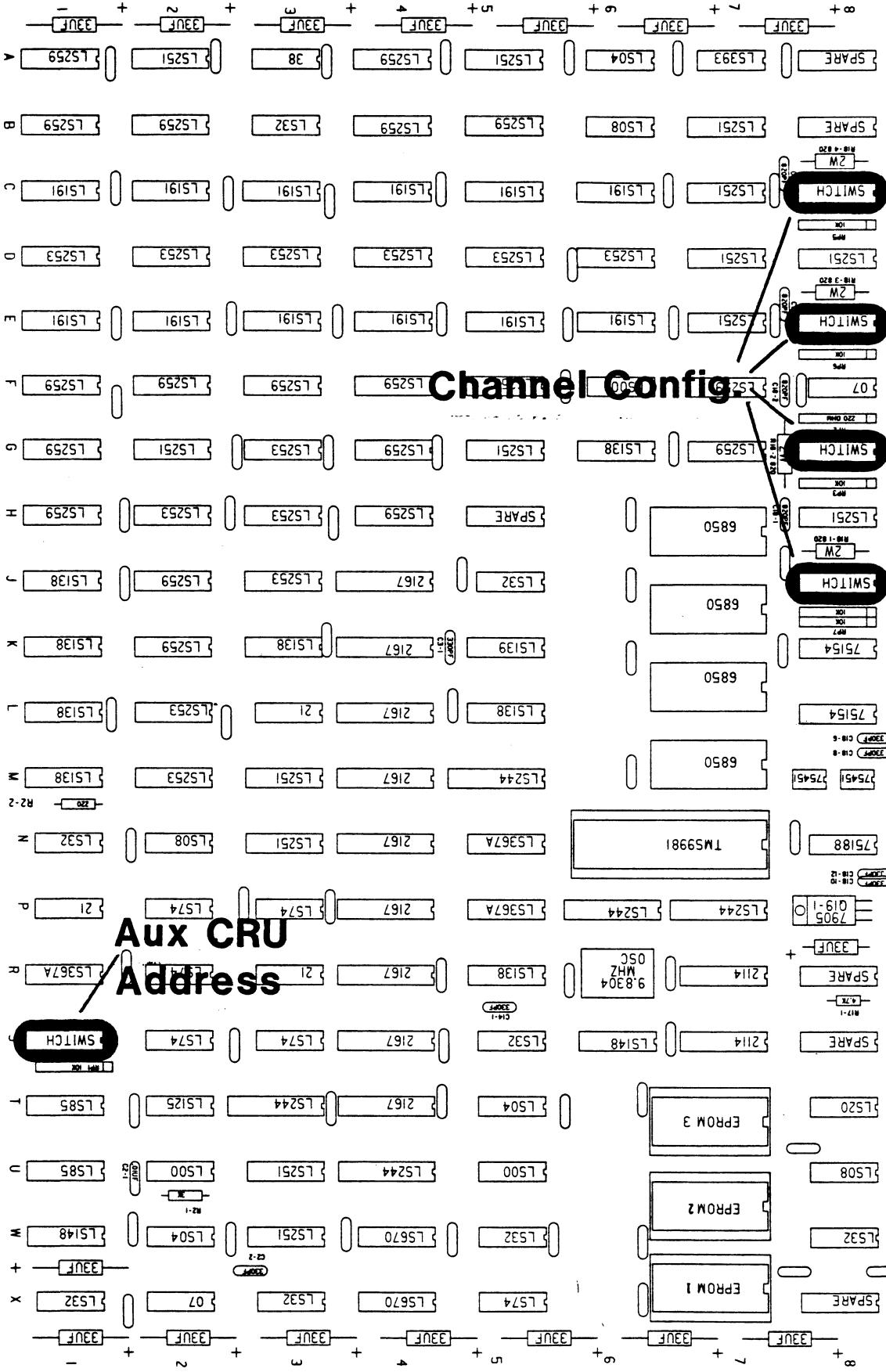

**Channel Config**

**Aux CRU Address**

911-E CONTROLLER

Figure 2.1

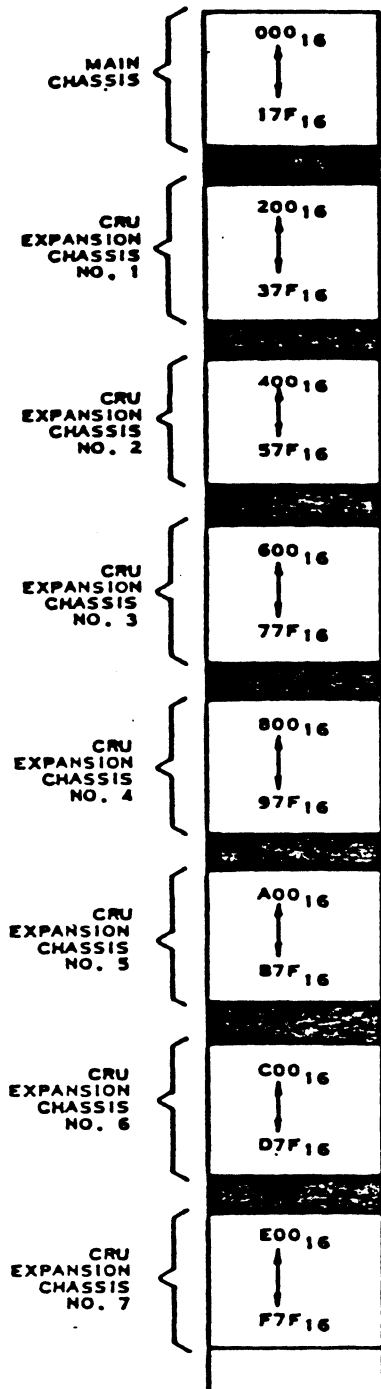

### CRU ADDRESS CALCULATION

A0									A15
0	0	0	0	0	0	0	0	0	0
0	0	0	0	1	0	0	0	0	0

FACTORY SET  
SAMPLE  
400<sub>16</sub>

ON(0) OFF(1)

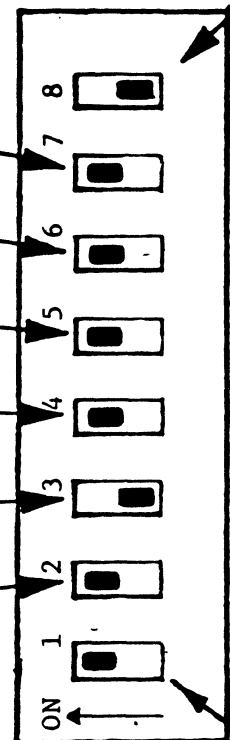

AUXILIARY CHANNEL ADDRESS SELECTOR

Not Used (off)

Reserved (on)

Figure 2.2

## 2.4 INTERRUPTS

Interrupts are generated as follows:

P1-66	P2-66
Channel "B"	Channel "A"
Channel "D"	Channel "C"

## 2.5 BAUD RATE

The baud rate for each channel is determined by that channel's "CONFIG" switch bank located behind the connector. See Figure 2.3.

## 2.6 EIA/CURRENT LOOP

The mode of operation for each channel is determined by that channel's "CONFIG" switch bank located behind the connector. See Figure 2.3.

\*\*\* NOTE \*\*\*

Do not set any line to current loop if it will not be connected to a terminal that is powered on. A large decrease in speed will occur if this is done.

## 2.7 ECHO/RUN

The "CONFIG" switch bank for each channel provides a diagnostic setting which may be used to quickly check the operation of the controller, the terminal and the interface cable. This is discussed in Section 5.0. THE SWITCH SHOULD BE SET IN THE "RUN" POSITION FOR NORMAL OPERATION. See Figure 2.3.

## 2.8 BURST/NORMAL

The BURST/NORMAL switch for each channel controls the performance aspects of the controller when using both low and high speed terminals on the same board. This is discussed in Section 6.0. See Figure 2.3.

## 2.9      BUFFERED F1

If the Buffer F1 switch is OFF the F1 and F2 keys will be buffered before sending them to the CPU. This will improve the Roll Function of these keys. If the Buffered F1 switch is ON the shifted F1 and F2 keys will be buffered and the unshifted keys will remain Real Time. See Figure 2.3.

Rate Select			Baud
ON	ON	ON	38.4K
ON	ON	OFF	19.2K
ON	OFF	ON	9600
ON	OFF	OFF	4800
OFF	ON	ON	2400
OFF	ON	OFF	1200
OFF	OFF	ON	600
OFF	OFF	OFF	300

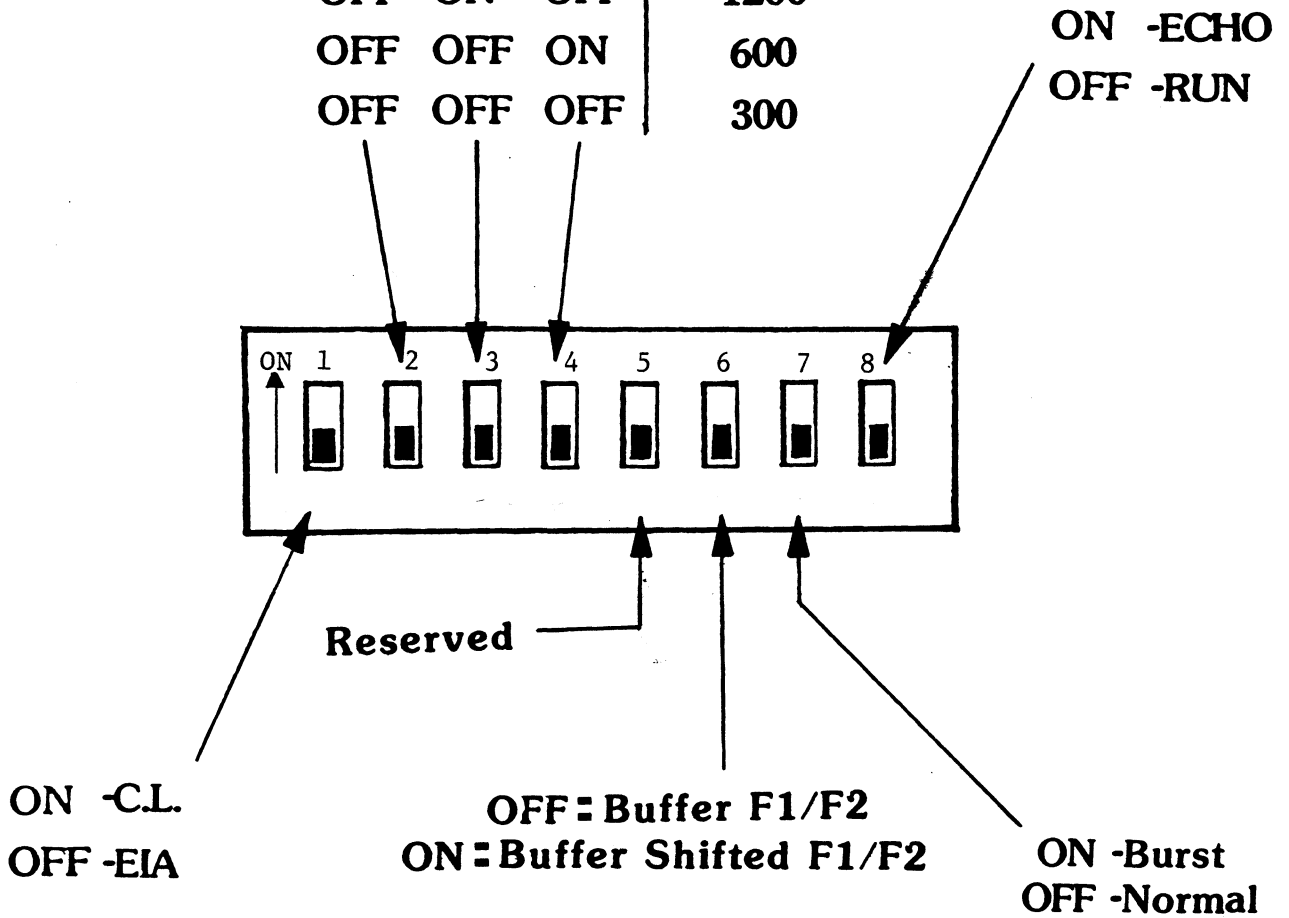

CHANNEL CONFIGURATION SELECTOR (ANY CHANNEL)

Figure 2.3



## 3.0      TERMINAL PREPARATION AND INTERFACE

### 3.1      SWITCH SETTINGS

The type and make of terminals supported by the 911-E are defined by several PROM devices on the controller. For proper operation the terminal's own configuration switches must be set to pre-defined levels. These settings are shown in the Appendix.

The only switches that are not defined are those that determine the baud rate. THE BAUD RATE SELECTED MUST MATCH THAT SET ON THE 911-E.

### 3.2      CABLES

Figure 3.1 shows the pin allocation for any of the 9-Pin connectors on the controller. Remember that EIA or Current Loop operation is determined by a configuration switch (Figure 2.3) behind the connector.

Refer to the Appendix for cable wiring diagrams associated with the type and make of the terminal being used.

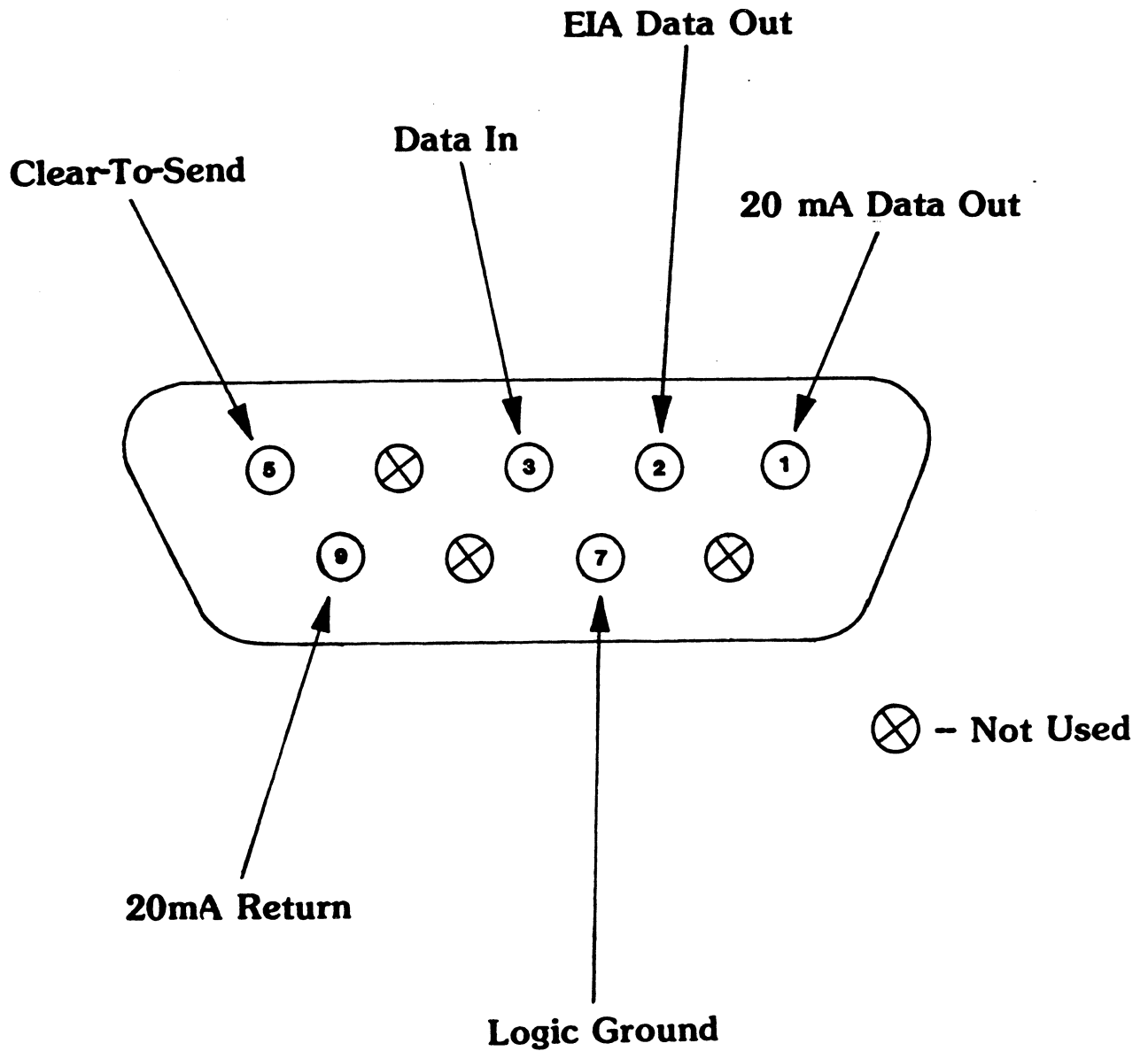

CONNECTOR PINOUT (BOARD EDGE VIEW)

Figure 3.1

## 4.0 SYSTEM GENERATION

### 4.1 OVERVIEW

Each channel of the 911-E is generated exactly the same as a 911 VDT.

### 4.2 EXAMPLE

The listing in Figure 4.1 is a portion of an "XGEN" on a DX10 3.5 system. The 911-E is to be installed in slot-5 of a 990/10A chassis. Thus the primary channels, "A" and "B", will have CRU addresses of >200 and >220, respectively. The auxiliary channels, "C" and "D", have been configured for CRU addresses >400 and >420, respectively.

Note that channels "A" and "C" interrupt on the P2 side of the chassis. Channels "B" and "D" interrupt on P1.

Device Type? VDI  
CRU Address? (>100) >200  
Access Type? (Record) <CR>  
Time Out? (0) <CR>  
Character Queue? (6) <CR>  
VDI Type? (911) <CR>  
Interrupt? (10) 3

Device Type? VDI  
CRU Address? (>100) >220  
Access Type? (Record) <CR>  
Time Out? (0) <CR>  
Character Queue? (6) <CR>  
VDI Type? (911) <CR>  
Interrupt? (10) 7

Device Type? VDI  
CRU Address? (>100) >400  
Access Type? (Record) <CR>  
Time Out? (0) <CR>  
Character Queue? (6) <CR>  
VDI Type? (911) <CR>  
Interrupt? (10) 3

Device Type? VDI  
CRU Address? (>100) >420  
Access Type? (Record) <CR>  
Time Out? (0) <CR>  
Character Queue? (6) <CR>  
VDI Type? (911) <CR>  
Interrupt? (10) 7

EXAMPLE "XGEN"  
Figure 4.1

## 5.0      INSTALLATION AND CHECKOUT

### 5.1      OVERVIEW

Once the controller (Section 2.0), the terminal (Section 3.0) and the system (Section 4.0) are prepared you can install the controller. Initially you will want to check the operation of the entire subsystem before putting it into service.

There are three troubleshooting "tools" to aid you; Self-test Flash Codes, Echo-Back and On-line T.I. DOCS.

### 5.2      SELF-TEST FLASH CODES

There is an indicator next to each connector. Under normal conditions these lights will be on or off. This means that there are no errors to report. (See Section 6.3).

However, should the indicators blink repeatedly something is wrong. The indicators will give a clue to the problem by displaying a "flash code": the lights will all flash "on" momentarily, then will flash one of the codes shown in Figure 5.1. Self-test is performed upon power-up.





























































This information, though not very useful to the customer, is extremely important to Custom Systems at the time of repair. Please include "flash code" information when returning a controller for repair.

\*\*\* NOTE \*\*\*

A "UART" flash code may be caused by incorrect wiring of a cable. Double check customer-made cables.

**Flash Code**

**Error**

				<b>Microprocessor Scratchpad Memory</b>
				<b>CRU Input Latches</b>
				<b>UART-Channel A</b>
				<b>UART-Channel B</b>
				<b>UART-Channel C</b>
				<b>UART-Channel D</b>
				<b>Display Memory Flags</b>
				<b>Baud Rate Clocks</b>
				<b>Reserved</b>
				<b>Reserved</b>
				<b>Reserved</b>
				<b>Reserved</b>
				<b>Reserved</b>
				<b>Reserved</b>
				<b>Reserved</b>

ERROR FLASH CODES

Figure 5.1

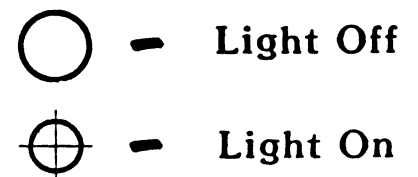

### 5.3 ECHO-BACK

Switch #8 (Figure 2.2) provides a direct echo-back feature for every channel. This feature allows the user to enter characters at the keyboard and see them displayed immediately on the screen. There is no system intervention.

Simple as it may seem a successful echo-back verifies the following:

- a) Cables are correctly wired and installed.
- b) The terminal's configuration switch banks are correctly set and the terminal itself is OK.
- c) The 911-E's configuration switch banks are correctly set and the communication section of the controller is OK.

If you are returning a controller to the factory for repair please include the results of the echo-back test (i.e. character typed versus character displayed).

RETURN THE ECHO SWITCH TO THE "RUN" POSITION FOR  
NORMAL OPERATION!

#### 5.4 ONLINE DIAGNOSTICS

T.I.'s Online Diagnostics provides an excellent means of checking the interface between the 990 and 911-E as well as an additional "run-time" verification of the 911-E to terminal interface.

Please keep in mind that not every terminal supported by the 911-E is identical to the T.I. 911. Graphic characters may vary slightly as well as other attributes. So visually the two may appear different. If the terminal is operating at a slower baud rate it may not be able to "keep up" with the computer. This too can result in poor visuals.

Regardless of the display there should be no errors reported to the error file. Please include these errors if returning a controller for repair.

\*\*\* NOTE \*\*\*

The 911-E DOES NOT support T.I.'s standalone (OFFLINE) diagnostics.



## 5.5 CUSTOMER SERVICE INFORMATION

Our warranty attests the quality of materials and workmanship in our products. If malfunction does occur, our service personnel will assist in any way possible. If the difficulty cannot be eliminated by use of the following service instructions and technical advise is required, please phone Custom Systems giving the serial number, board name, model number and problem description. You will be placed in contact with the appropriate technical assistance.

### PRODUCT RETURN

#### Returned Material Authorization.

Before returning a product to Custom Systems for repair, please ask for a "Returned Material Authorization" number. Each product returned requires a separate RMA number. Use of this number in correspondence and on a tag attached to the product will ensure proper handling and avoid unnecessary delays.

#### Returned Material Information.

Information concerning the problem description, system configuration, diagnostic program name, revision level results, i.e., error program counter number should be included with the returning material. A form is provided for this information on the next page of the manual.

#### Packaging.

To safeguard your materials during shipment, please use packaging that is adequate to protect it from damage. Mark the box "Delicate Instrument" and indicate the RMA number(s) on the shipping label.

### WARRANTY

The Custom Systems' 911-E is warranted against defects in material or workmanship for a period of two years from the date of shipment. Defective units covered by this warranty shall be returned to Custom Systems' confirmation of the defect, the defective parts or the entire unit shall be repaired or replaced and returned to the Purchaser.

### SERVICE

Service of Custom Systems' products is provided at our Minneapolis facility. 911-E's returned to the factory are in most cases repaired and shipped within two days. Service at the Purchaser's facility is also available on a time and expenses basis.

Service of the 911-E by a Purchaser or by skilled personnel in the Purchaser's locale following the warranty period is facilitated by the complete package of documentation provided with each unit.



(include with returning material)

MATERIAL RETURN INFORMATION

All possible effort to test a suspected malfunctioning 911-E should be made before returning it to Custom Systems, Inc. for repair. This will: 1) Determine if in fact it is defective (many boards returned for repair are not defective, causing the user unnecessary system down-time, paperwork and handling while proper testing would indicate it is working properly). 2) Increase the speed and accuracy of product's repair which is often dependent upon a complete understanding of the user checkout test results, problem characteristics, and the user system configuration.

Please allow our Service Department to do the best job possible by answering the following questions thoroughly and returning this sheet with the malfunctioning board.

- 1. Slot location of 911-E \_\_\_\_\_
CRU Address of Secondary Channels \_\_\_\_\_
CPU (check one) 990/4 990/5 990/10 990/10A
990/12 990/12A
2. List other CRU devices in system. \_\_\_\_\_
3. Revision level of operating system (i.e. 3.5.2). \_\_\_\_\_
4. Does problem change if another terminal and/or cable is used? Yes \_\_\_ No \_\_\_
5. Does the 911-E fail Self-test? If so, indicate the flash code as represented in Figure 5.1.
6. Does the 911-E pass the echo test. If not, indicate the failure(s).

Table with 2 columns: CHARACTER TYPED, CHARACTER DISPLAYED. Includes three rows of blank lines for data entry.

- 7. (OPTIONAL) Does the 911-E fail ONLINE DOCS? If so, how? (Attach a copy of HISTORY file if possible) \_\_\_\_\_
8. Does the problem seem intermittent or heat sensitive?
9. Briefly describe problem. \_\_\_\_\_

To be filled out by CUSTOMER:

Model #: \_\_\_\_\_ Serial #: \_\_\_\_\_ RMA #: \_\_\_\_\_

Returned by:
Company Name: \_\_\_\_\_
Return Address: \_\_\_\_\_
Contact Name: \_\_\_\_\_
Phone Number: \_\_\_\_\_



## 6.0 OPERATION

### 6.1 911 VERSUS 911-E

The one outstanding difference between the 911 and 911-E is the interface between the controller and the terminal.

The T.I. 911 converts the characters present in memory to a stream of composite video. The terminal is basically a video monitor. Thus the speed at which the screen can be re-written is solely dependent on the speed at which the operating system can update the memory. This is why the 911 is so fast.

The 911-E employs the industry standard RS232-C communications format. Because of this the screen cannot be updated as quickly as the memory. This format, however, allows for an extra two channels per slot at a substantial cost per channel advantage. And by using a full duplex modem the user can run remote operations in VDT mode. Finally the user does not have to "XGEN" special devices using non-standard DSR's.

## 6.2      SPEED CONSIDERATIONS

In most applications the speed of the 911-E will be adequate under normal "VDT" mode operations. The user should understand that some high speed programs will overrun the controller's capacity for screen updates. The following suggestions are made to obtain the best overall performance:

- A. Run all terminals at the highest allowable baud rate.
- B. If mixing high and low speed terminals use the "BURST" function switches (see Section 6.4).
- C. If several channels are NOT being used either disconnect the cables or power-down the terminals (this must be done BEFORE the computer is powered up or BEFORE a RESET is performed). This allows the 911-E to service the "ONLINE" terminals more quickly.

## 6.3      INDICATORS

Each connector has an indicator next to it. (If the indicators are flashing see Section 5.2.) Upon power-up or I/O Reset the 911-E scans each channel to see if the terminal is online and ready. If it is the indicator will turn on and stay on indefinitely.

\*\*\* NOTE \*\*\*

If the terminal was not ready at that time, but is now, simply hit any key on the keyboard to bring the terminal "ONLINE".

#### 6.4      BURST MODE

Each channel has two modes of operation; "BURST" and "NORMAL", controlled by a switch behind the connector (see Figure 2.3).

In the "NORMAL" mode each terminal is updated line-by-line. In this way no one terminal has priority over another. THIS MODE SHOULD BE USED WHEN ALL TERMINALS ARE OPERATING AT OR NEAR THE SAME BAUD RATE.

In the "BURST" mode each terminal is updated an entire screen at a time. THIS MODE SHOULD BE USED IN A CONFIGURATION WITH INTER-MIXED BAUD RATES, AND THEN ONLY ON THE HIGHER SPEED TERMINALS.

For instance, if channels A and B are operating at 19.2K baud, and channels C and D are operating at 1200 baud, set channels A and B for "BURST" mode.





APPENDIX - A

NATIONAL COMPUTER SYSTEMS (NCS) 911-E

APPLICATION INFORMATION



## 1.0 INPUT DIFFERENCES BETWEEN T.I. 911 AND NCS 911-E

### 1.1 INPUT CONVERSION

The following is a Conversion List for keys on the T.I. 911 that will be accessed by different keys on the NCS 911-E.

T.I. 911 KEY(S)	NCS 911-E EQUIVALENT KEY(S)
ESC	ESC, ESC
CTRL Q	ESC, CTRL Q
CTRL S	ESC, CTRL S
ERASE INPUT	ERASE INPUT OR DEL LINE
BLANK GRAY	INS LINE

### 2.0 OUTPUT DIFFERENCES

Table A-1 defines differences in the Graphic Sets of the T.I. 911 and the NCS 911-E.

### 3.0 NCS 911-E CONFIGURATION INFORMATION

Figures A-1 and A-2 are provided for ease of configuring the NCS 911-E and for cabling between the NCS 911-E and the 911-E controller.

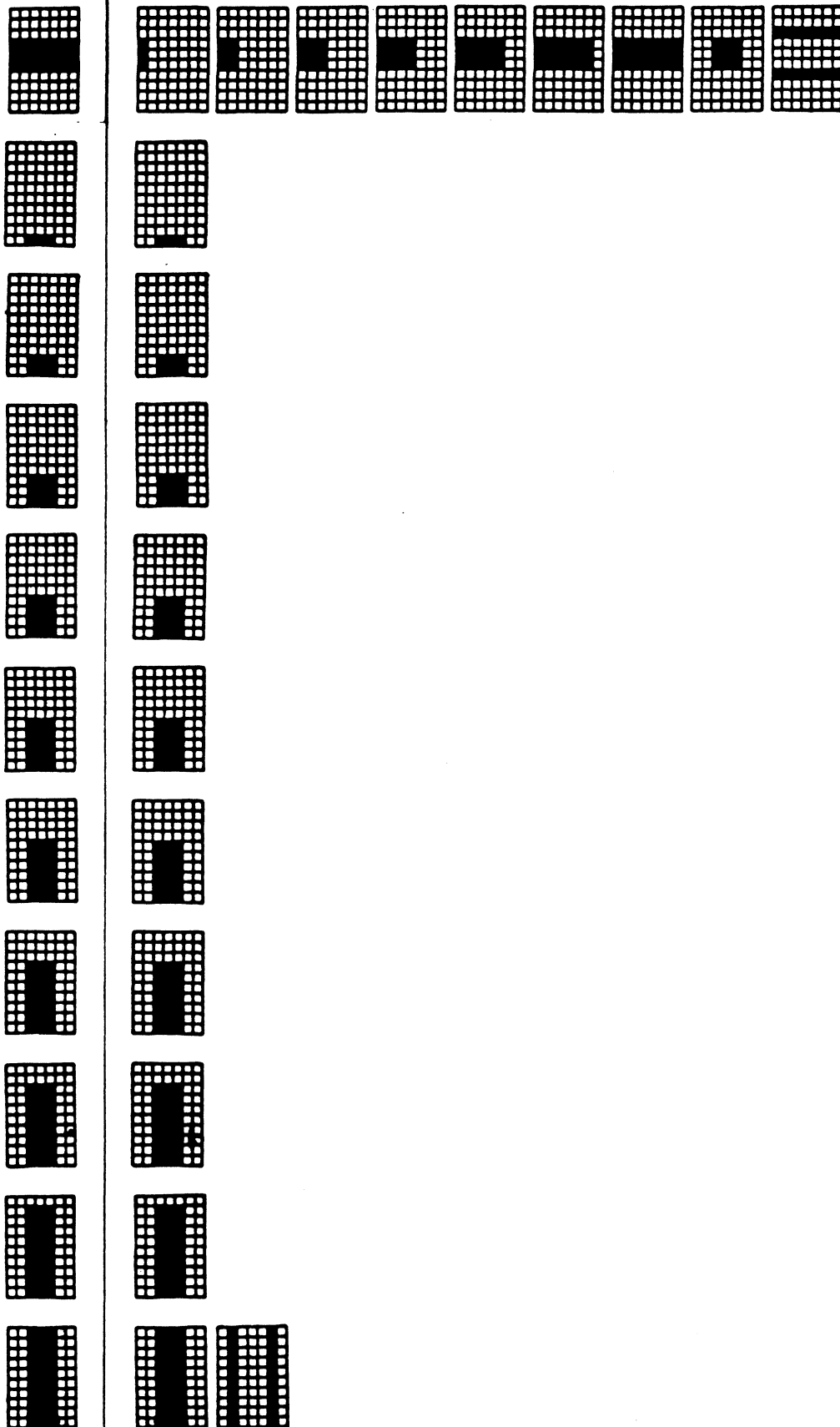

T.I. 911 VS NCS 911-E GRAPHIC SET  
TABLE A-1

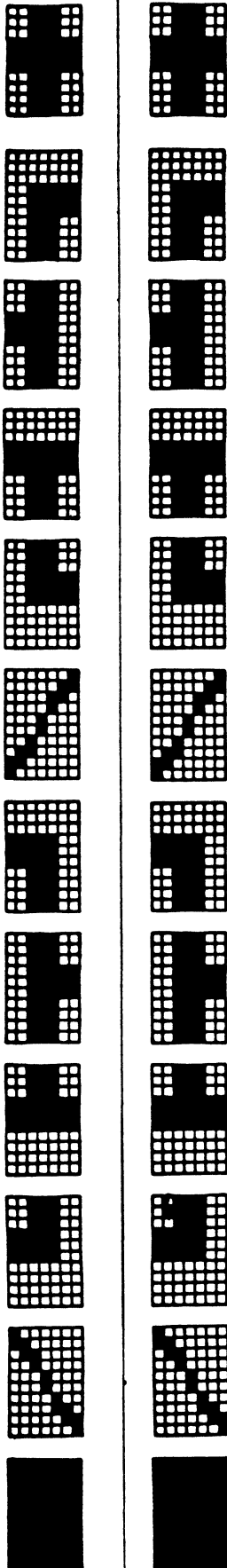

T.I. 911 VS NCS 911-E GRAPHIC SET (CONT.)  
TABLE A-1

# NCS 911E

## Configuration Switch Settings

(as seen from right side of terminal)

Printer Port

See NCS 911E Manual

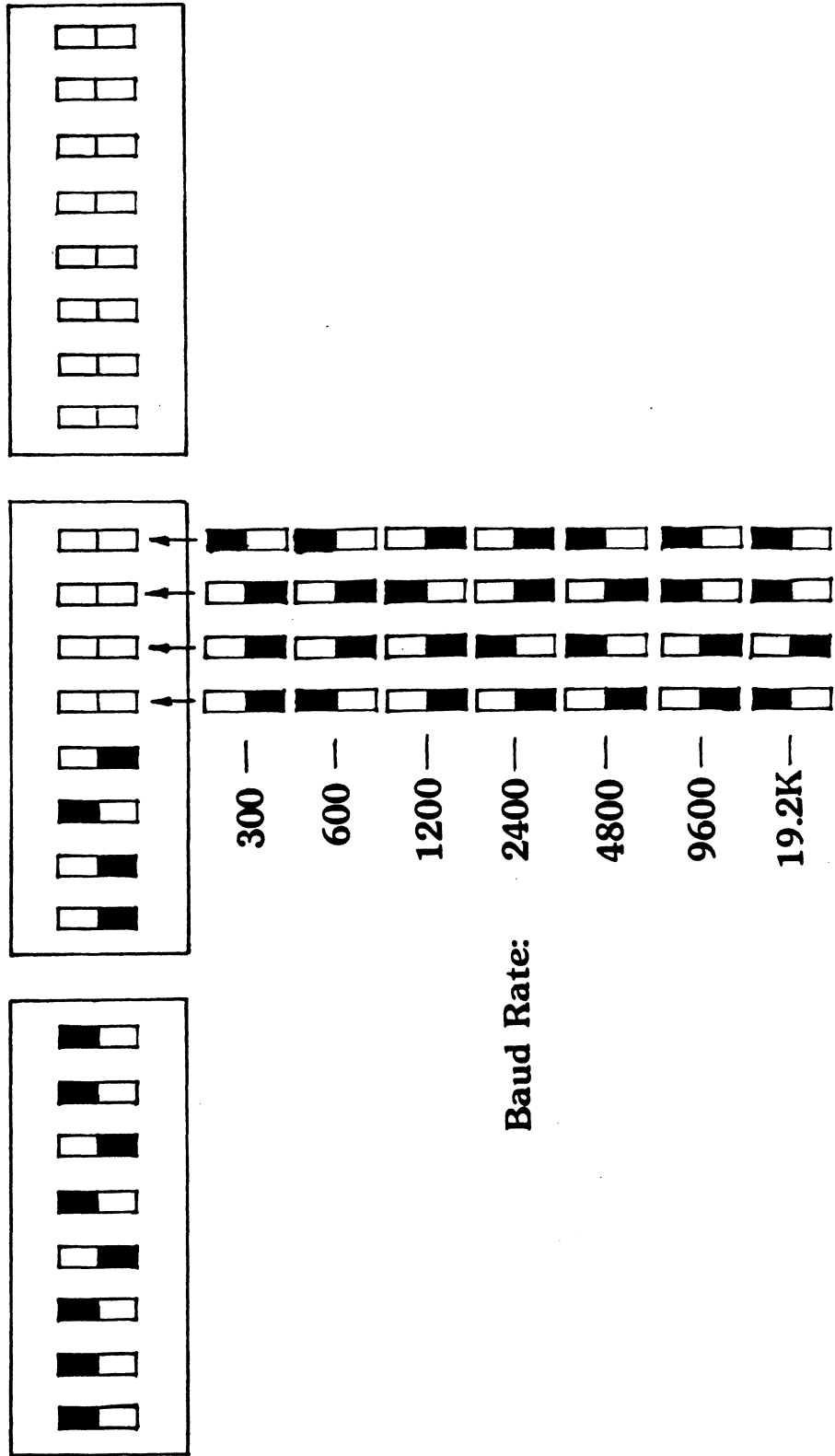
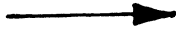

FIGURE A-1

# ***NCS 911E***

## **Suggested Cable Diagram**

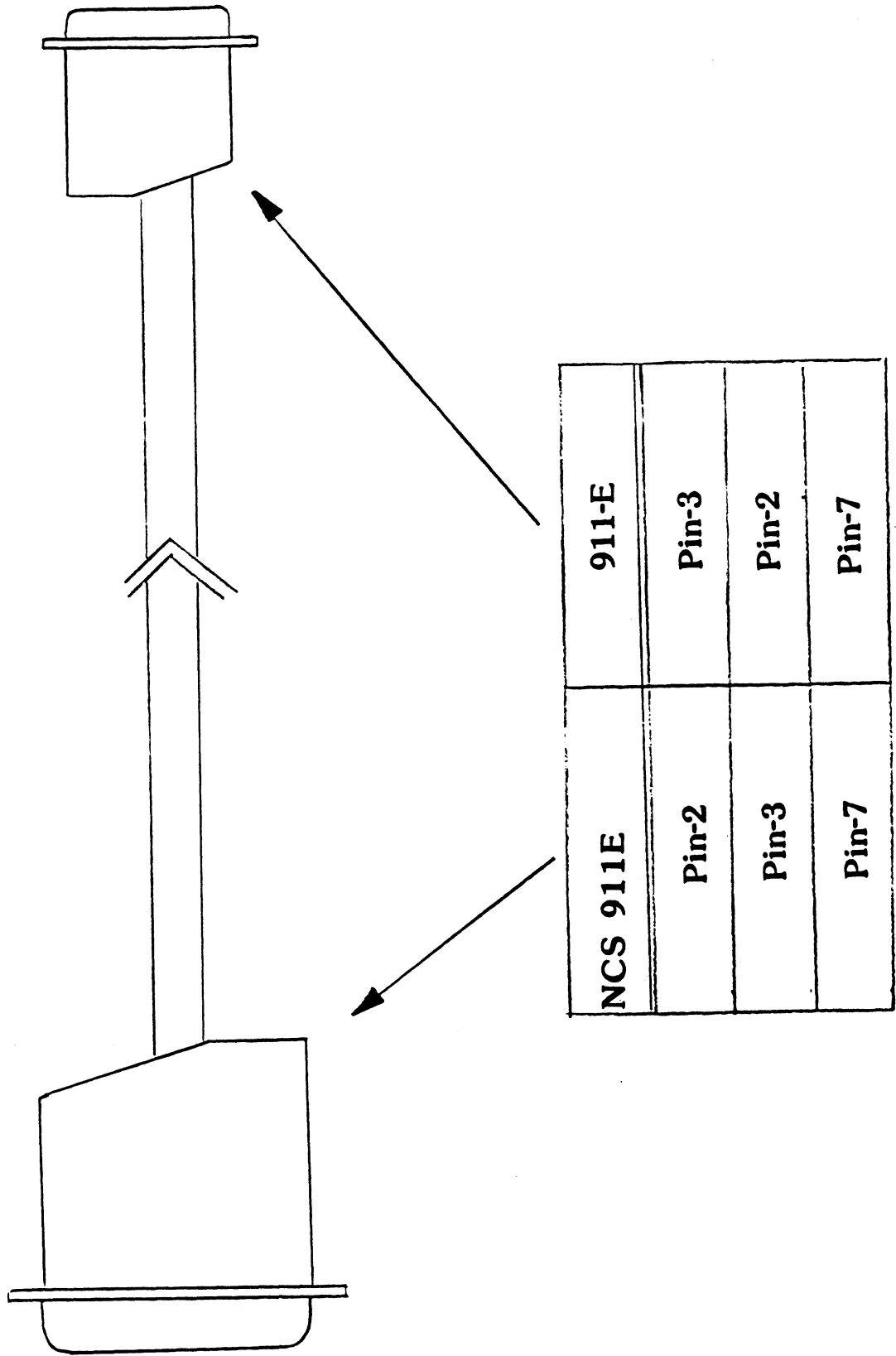

FIGURE A-2

APPENDIX - B

TELEVIDEO 950

APPLICATION INFORMATION





## 1.0 INPUT DIFFERENCES BETWEEN T.I. 911 AND TELEVIDEO 950

### 1.1 INPUT CONVERSION

- A. The following is a conversion list for keys on the TI 911 that will be accessed by different keys on the Televideo.

	TI 911 KEY(S)	TELEVIDEO EQUIVALENT KEY(S)
1.	CHAR <--	<--
2.	FIELD <--	BACKTAB
3.	ESC	ESC, ESC
4.	SKIP	CLEAR SPACE
5.	ERASE FIELD	LINE ERASE
6.	ERASE INPUT	LINE DELETE
7.	BLANK GRAY	LINE INSERT
8.	PRINT	SEND
9.	CTRL 8 (!)	!
10.	CTRL 9 (`)	`
11.	CTRL 0 (~)	~
12.	CTRL +(GS)	CTRL [ ]
13.	CTRL -(DEL)	DEL
14.	CTRL _(\)	\
15.	CTRL ;({)	{
16.	CTRL ' (})	}
17.	CTRL ,(FS)	CTRL \
18.	CTRL / (US)	CTRL _
19.	CTRL A(SOH)	CTRL A, CTRL A
20.	CHAR -->	-->
21.	CMD	F10
22.	BLANK ORANGE	F11
23.	ENTER	F9

### 1.2 NON-SUPPORTED CONTROL FUNCTIONS

Following is a list of T.I. 911 control functions and their associated key sequences (i.e. XF1, XF2, BREAK, etc.) which are unobtainable on the Televideo 950. Use corresponding Televideo 950 key sequences only when required by key conversion table.

NON-SUPPORTED T.I. 911-E  
FUNCTIONS ON TELEVIDEO 950

KEY SEQUENCES TO AVOID  
"DO NOT USE"

(FIELD RIGHT)  
(HERE IS)  
(BREAK)  
(XF1)  
(XF2)  
(XF3)  
(XF4)  
(B5)  
(HT)  
(LF)  
(VT)  
(FF)  
(SYN)  
(SUB)  
(RS)

FIELD >  
CTRL 1  
CTRL 2  
CTRL 4  
CTRL 5  
CTRL 6  
CTRL 7  
CTRL H  
CTRL I  
CTRL J  
CTRL K  
CTRL L  
CTRL V  
CTRL Z  
CTRL .

## 2.0 OUTPUT DIFFERENCES BETWEEN T.I. 911 AND TELEVIDEO 950

### 2.1 THE GRAPHIC CHARACTERS DIFFER SIGNIFICANTLY

T.I. uses 32 graphic characters, while the Televideo uses only 15 graphic characters. Of these 15 characters only 11 match with a T.I. counter part. Since the "solid square" character is used by the standard DX10 and there is no Televideo part we have equated this character to the "+" graphic character on the Televideo so as to enable the use of the SCI commands SMM and SSTM.

See Table B-1 for a comparison between T.I. 911 and Televideo equivalents.

### 2.2 80TH CHARACTER ON LINE 24

The 80th character on line 24 can never be printed. This is due to the fact that if this position is printed the Televideo will automatically roll up the screen.

### 2.3 STATUS LINE

A status line will be present at all times on line 25 of the Televideo 950.

## 3.0 TELEVIDEO 950 CONFIGURATION INFORMATION

Figures B-1 and B-2 are provided for ease of configuring the Televideo 950 and for cabling between the Televideo and the 911-E controller.

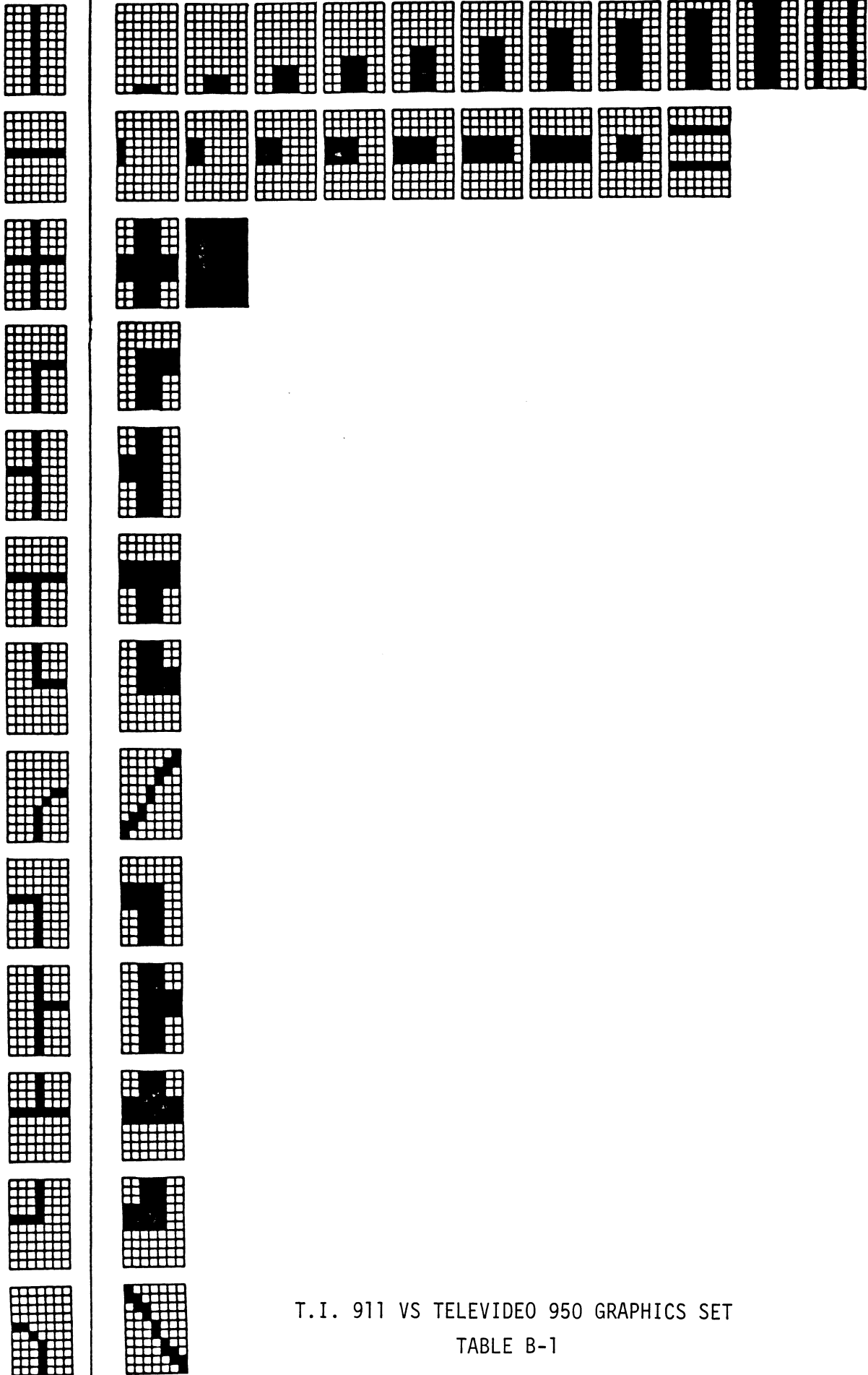

T.I. 911 VS TELEVIDEO 950 GRAPHICS SET

TABLE B-1

# TELEVIDEO 950

Suggested EIA Cable Diagram

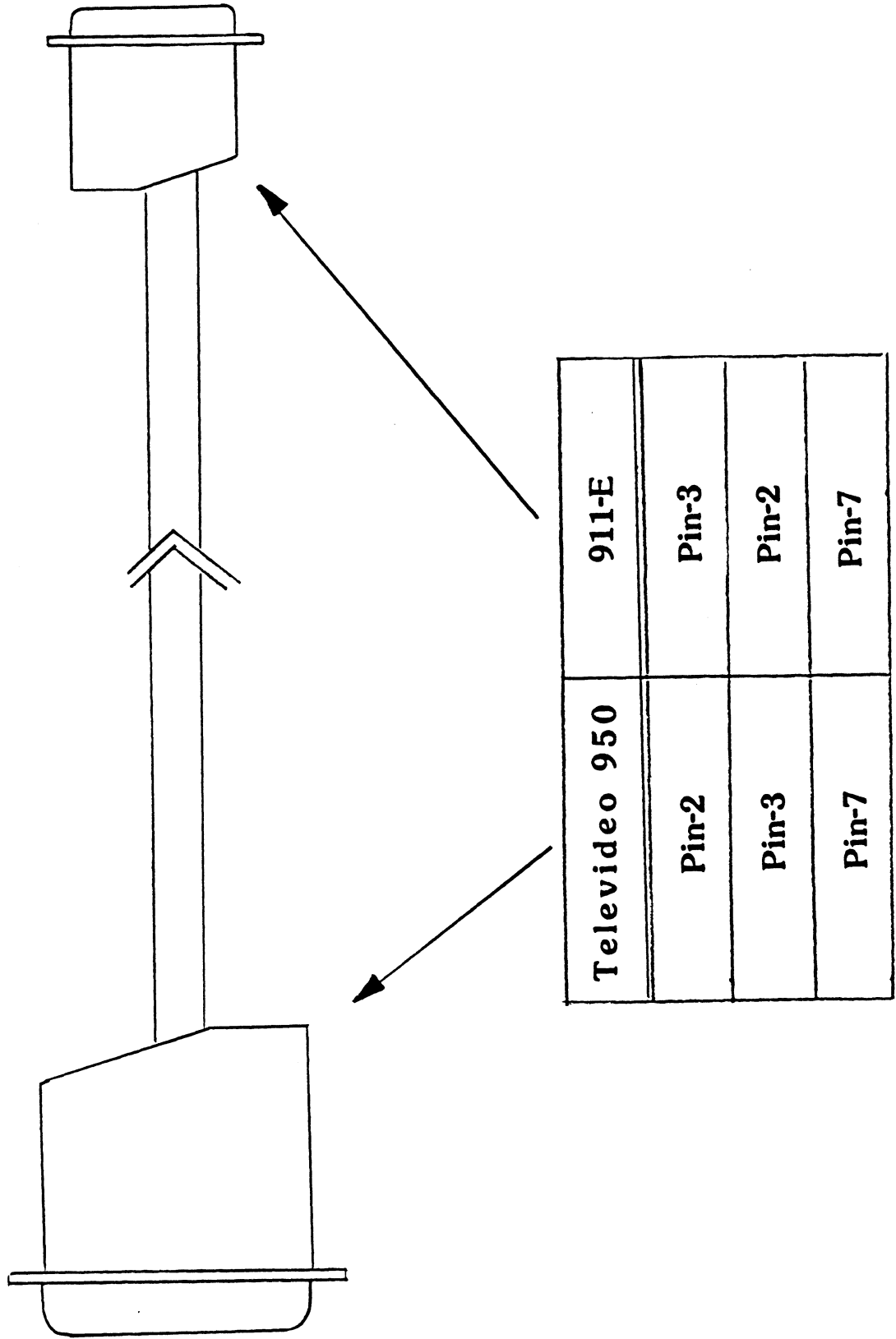

FIGURE B-1

# TELEVIDEO 950

## Suggested CURRENT LOOP Cable Diagram

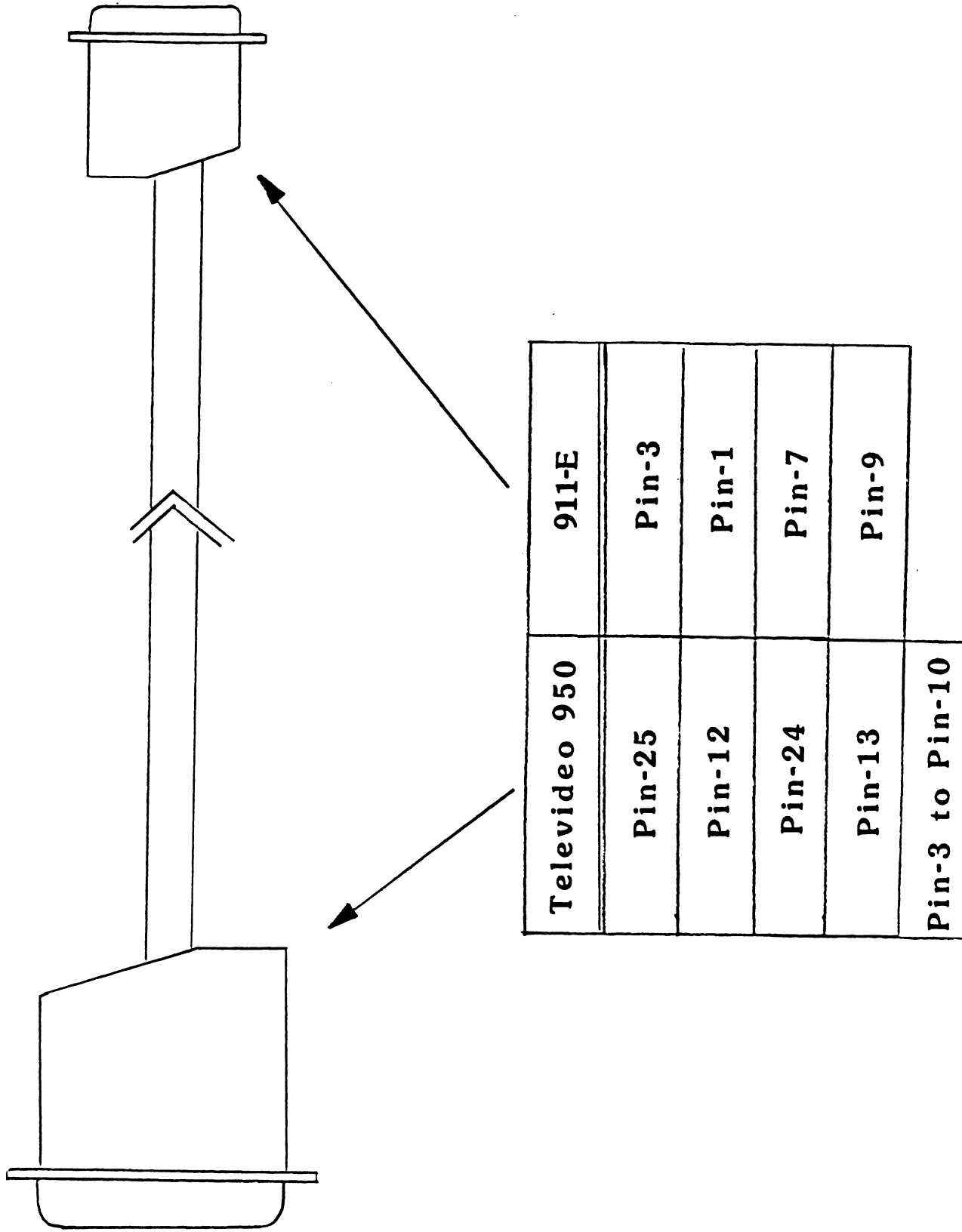

FIGURE B-2

# TELEVIDEO 950

## Configuration Switch Settings

(as seen from rear of terminal)

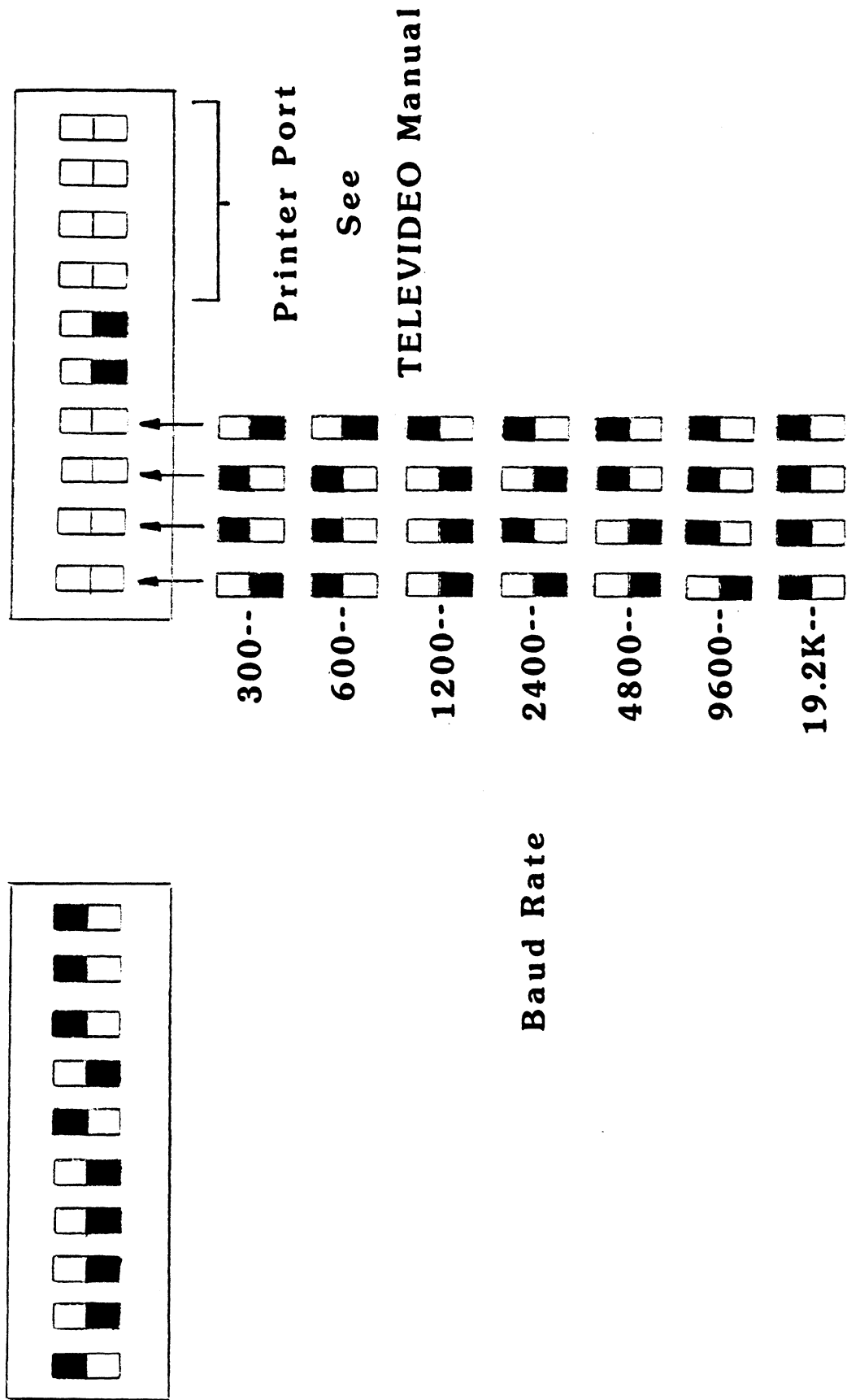

FIGURE B-3





APPENDIX - C

TEXAS INSTRUMENTS 931  
APPLICATION INFORMATION



## 1.0 INPUT DIFFERENCES BETWEEN T.I. 911 AND T.I. 931

### 1.1 INPUT CONVERSION

- A. The following is a Conversion List for keys on the T.I. 911 that will be accessed by different keys on the T.I. 931.

T.I. 911 KEY (S)	T.I. 931 KEY (S)
1. ESC	ESC, ESC
2. CTRL S (DC3)	ESC, CTRL S (DC3)
3. CTRL Q (DC1)	ESC, CTRL Q (DC1)
4. CTRL 3 (NUL)	CTRL
5. CTRL 8 ( )	
6. CTRL 9 (')	'
7. CTRL 0 (~)	~
8. CTRL + (GS)	CTRL ]
9. CTRL <- (\)	\
10. CTRL , (FS)	CTRL \
11. CTRL . (RS)	CTRL / SHIFT 6
12. CTRL / (US)	CTRL -
13. CHAR <	<
14. CHAR >	>
15. CTRL 1	F9

### 1.2 NON-SUPPORTED CONTROL FUNCTIONS

- A. The following is a list of Control Key Sequences that will not be supported on the T.I. 931 version.

#### T.I. 911 SEQUENCE COMMENTS

1. CTRL 2 (BREAK)
2. CTRL 4 (XF1)
3. CTRL 5 (XF2)
4. CTRL 6 (XF3)
5. CTRL 7 (XF4)
6. CTRL - (DEL)
7. CTRL ; (>7B)
8. CTRL ' (>7D)
9. CTRL I (HT)

## 2.0 OUTPUT DIFFERENCES BETWEEN T.I. 911 AND T.I. 931

### 2.1 STATUS LINE

A Status Line will be present in the 25th line. This can be disabled by typing simultaneously Alt 2.

### 3.0 T.I. 931 CONFIGURATION INFORMATION

Tables C-1 and C-2 are provided for ease of configuring the T.I. 931 and for cabling between the T.I. 931 and the 911E controller.

#### SUGGESTED EIA CABLE TABLE

T.I. 931	911E
PIN-2	PIN-3
PIN-3	PIN-2
PIN-7	PIN-7
PIN-6 TO PIN-20	

TABLE C-1

#### CONFIGURATION TABLE

COMM SPEED: 19200  
COMM PARITY: ODD  
COMM RECEIVE PARITY CHECK: ON  
COMM TRANSMIT BLOCK SIZE: FF  
COMM TRANSMIT BLOCK DELAY: 00  
COMM PORT: EIA OR INTERNAL  
COMM RECEIVE DC1/DC3: OFF  
CURSOR: BLOCK OR UNDERLINE  
VIDEO TIMER: ON OR OFF  
DISPLAY FREQ: 50 Hz or 60 Hz

TABLE C-2

APPENDIX - D

ADDS VIEWPOINT  
ADDS REGENT 25

APPLICATION INFORMATION



1.0 EPROMS REQUIRED

Eprom #1: P10000  
Eprom #2: P10100  
Eprom #3: Not Used

1.2 INPUT DIFFERENCES BETWEEN TI 911 AND ADDS

- A. Not all control characters will match.
- B. The following Table must be used for access to the function keys and the edit keys.

CONVERSION TABLE

FUNCTIONS	911	ADDS
	F1;SHIFT F1	ESC 1;ESC !
	F2;SHIFT F2	ESC 2;ESC "
	F3	ESC 3
	F4	ESC 4
	F5	ESC 5
	F6	ESC 6
	F7	ESC 7
	F8	ESC 8
	CMD	ESC 9
	BLK ORANGE	ESC 0

EDITS	911	ADDS
	ERASE FIELD	ESC Q
	ERASE INPUT	ESC W
	BLANK GRAY	ESC E
	PRINT	ESC R
	HOME	ESC T
	INS CHAR	ESC Y
	DEL CHAR	ESC U
	ENTER	ESC I
	SKIP	ESC O
	FIELD LEFT	ESC A
	FIELD RIGHT	ESC S
	ESC	ESC ESC



## 2.0 OUTPUT DIFFERENCES BETWEEN TI 911 AND ADDS

- A. When the system is booted no boot up message will appear on the Adds until a key is hit. This key is not sent to the computer.
- B. All graphics characters will appear as ACSII characters A thru Z.
- C. No dual intensity is supported.

## 3.0 CONFIGURATION INFORMATION

The terminal must be set as follows:

7 Data Bits  
1 Stop Bit  
Odd Parity  
No Auto Scroll