

August 1989

# FOCUS

## The Magazine of the North American Data General Users Group

# NEWS

### Database management by the numbers

Bulk Rate  
U.S. Postage  
Paid  
Permit No. 38  
Fulton, MO

# Why wait weeks for a 20-minute report?



**Y**ou probably think a report request means a long-term assignment. As for programming those new and revised applications — that could take days, even weeks. With run times that might run into hours.

That was before CQCS™, the full-functioned fourth generation language. CQCS is so easy to use, it can make your DG programmers up to ten times more productive. From the very first day.

## REPORT WRITING MADE EASY.

If you've been using some other report writer, you're in for a shock. With CQCS, you'll produce in half an hour what used to take half a lifetime. While your run times shrink to a matter of minutes.

## GRAPHIC SIMPLICITY.

Only the CQCS report writer features a built-in, *automatic* interface to Trendview. So you get hard-hitting charts and graphs — without having to learn a new program.

And all for no more machine overhead than it takes to run COBOL.

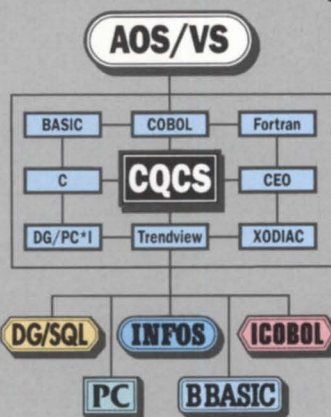
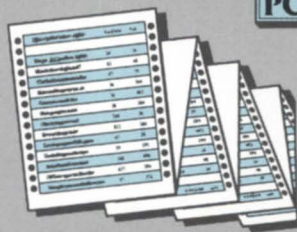

**YOU CAN USE YOUR EXISTING DATABASE.** CQCS grew up with DG. It gets along fine with INFOS, ICOBOL, B BASIC and DG/SQL in any combination. No modifications required.

What's more, CQCS can integrate these data environments with an existing application written in any DG third generation language.

And you'll enjoy that same easy integration with packages like Trendview, CEO, DG/PC\*I and XODIAC.

## MAXIMIZE YOUR RESOURCES.

So why wait another day? The sooner you get CQCS, the faster you can solve your productivity problems. With the very same hardware, software and data structure you're using today.

**CALL US TODAY AT 1-800-451-1544. IN EUROPE, CALL +44-992-441111.**

Find out more about the most widely licensed 4GL in the international MV community. And discover how it feels to have all your resources producing at 100%.

Because after all, there's no percentage in just waiting around.

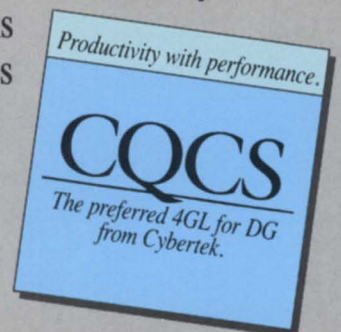

FIVE SOLID REASONS  
FOR MAKING BL ASSOCIATES YOUR HARDWARE SOURCE.



THE LAST PLACE YOU'LL FIND THESE GUYS IS ON THE COVER OF A FASHION MAGAZINE.  
BUT, WHEN IT COMES TO DG & COMPATIBLE COMPUTERS, THEY'RE SOLID.  
MEET THE STAFF AT BL ASSOCIATES: FIVE INDIVIDUALS COMMITTED  
TO THE SALES AND SERVICE OF DATA GENERAL HARDWARE.

IF YOU'RE BUYING OR SELLING DG & COMPATIBLE EQUIPMENT, TAP INTO THEIR YEARS  
OF EXPERIENCE UP FRONT. YOU'LL GET EXPERT ANALYSIS OF YOUR HARDWARE  
REQUIREMENTS AND SAVE PLENTY OF HEADACHES IN THE PROCESS. THEY'LL  
PROVIDE INTELLIGENT RECOMMENDATIONS ON DG HARDWARE OR COMPATIBLE  
ALTERNATIVES LIKE DATARAM AND ZETACO AND YOU'LL RECEIVE A  
DEMONSTRATION OF JUST HOW THE NEW SYSTEM WORKS.

OTHER DEALERS MAY PROVIDE EQUIPMENT, BUT BL ASSOCIATES GOES BEYOND TO  
PROVIDE REAL INNOVATIVE SOLUTIONS . . . AND THATS THE MOST SOLID REASON OF ALL.



A S S O C I A T E S

D.G. HARDWARE AND ALTERNATIVES • WITH THE STRUCTURE TO SUPPORT THEM

145 WEBSTER STREET, SUITE A, HANOVER, MA 02339  
TEL. (617) 982-9664 • FAX (617) 871-4456

Circle 3 on reader service card.

**DATARAM**  
AUTHORIZED DISTRIBUTOR

**ZETACO**

**DATARAM**  
AUTHORIZED DISTRIBUTOR

P.C. & COMPATIBLES

## FOCUS ON:

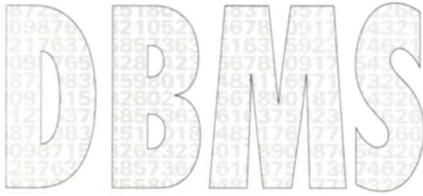

### Data base update

Data General's strategy for data base management is highlighted in this interview with Mike Normile

20

### Full-service or self-service?

The efficiency with which a particular server architecture manages interactions should be a key consideration of the DBMS buyer

by Jojo Anonuevo

27

### They went data way

Reader survey reveals that data base management comes in all forms

by Robin Perry

34

### Sonoma County traffic report

34

### Healthy customer list

invigorating for Life Fitness

37

### Building blocks for design

Armed with a few basic design principles and the right development system, many people can implement their own solutions for managing office information

by Sue Dintelman

40

## PRESIDENT'S PAGE

What I did this summer  
by Donald W. Clark

## LETTERS

Comments from our readers

## ROUNDUP

### See you in September

Fill out your reports, make your reservations—Conference '89 is just around the corner

by Cathlene Gentry

## NADGUG NEWS

### Countdown to Conference '89

Patricia Seybold and Tom West are keynoters; many extras in store for attendees

## DAA

### User-centered computing

DAA is the umbrella concept Data General is using as it works toward the goal of giving users utility-like access to computing power. This article gives a high-level overview of the approach and its benefits

by Chris Stone and Michael Cromer

## COMMUNICATIONS

### Trade wars

Many factors can affect the accuracy and speed of data transfer. This article analyzes several trade-offs between performance and cost

by Rainer McCown

## SOFTWARE LIBRARY

A complete listing of the NADGUG software library

## SYSTEM CONCEPTS

### Do you speak my language?

Secret decoder rings, encryption engines, or plain data transformation: there are ways to streamline the process of translating character sets

by Michael Dupras

## SYSTEM MANAGER'S LOG

### A good mystery for summer reading

An MV/10000 running benchmarks gets "turned on" at certain speeds. If you like to play detective, see if you can figure out why

by Brian Johnson

56

## DISCOVERIES

### Some tape is reel attractive—even magnetic

The author continues a discussion on backups by looking at various off-line storage devices available for use with DG systems

by Jim Siegman

61

## PRODUCT REVIEWS

### Less is more

The unit looks good, the front panel is efficient, and the footprint is so small that the cables weigh more than the drive. Our reviewer tests the Megatape GT-88 tape drive

by Tim Boyer

65

## DG CORPORATION

Recent changes in the corporate structure

68

## BULLETIN BOARD

Bits and bytes from the bulletin board

69

## PRODUCTS AND SERVICES

The latest products for DG systems

71

## ON-LINE HELP

Who to call about NADGUG and Focus

74

## PRISM

Brief notes from the DG community

76

Focus, the Magazine of the North American Data General Users Group (ISSN 0883-8194) is the official monthly publication of the North American Data General Users Group (NADGUG) in cooperation with Turnkey Publishing, Inc.

NADGUG offices are located at Stillhouse Canyon Office Park, 4807 Spicewood Springs Road, Suite 3150, Austin, Texas 78759, phone 512/345-5316.

Postmaster: Send address changes to Subscription Department, Turnkey Publishing, Inc., Stillhouse Canyon Office Park, 4807 Spicewood Springs Road, Suite 3150, Austin, Texas 78759.

Focus Magazine is distributed to members of the North American Data General Users Group.

Membership fees are \$40 per person. A one-year subscription to Focus (12 issues) costs \$36. For all memberships and subscriptions outside North America, add \$50 to defray costs of mailing. For information on NADGUG membership, call 1-800/877-4787. Address all other correspondence to Focus Magazine, c/o Turnkey Publishing, Inc., Stillhouse Canyon Office Park, 4807 Spicewood Springs Road, Suite 3150, Austin, Texas 78759.

NADGUG is an independent association of computer users: it is not affiliated with Data General Corporation, nor does it represent the policies or opinions of Data General Corporation. The views expressed herein are the opinions of the authors, and do not necessarily

represent the policies or opinions of NADGUG or of Turnkey Publishing, Inc.

Advertisements in Focus do not constitute an endorsement of the advertised products by NADGUG or Turnkey Publishing, Inc.

Copyright © 1989 by the North American Data General Users Group. All rights reserved. Reproduction or transmission of contents in whole or in part is prohibited without written permission of the Publisher. The Publisher assumes no responsibility for the care and return of unsolicited materials. Return postage must accompany all material if it is to be returned. In no event shall receipt of unsolicited material subject this magazine to any claim for holding fees or similar charges.

# The shortest distance to a complete installation is a direct line.



When you buy products for your Data General computer you want someone who understands your equipment. Which is why you should call us—DATA GENERAL DIRECT. Because we design and test each product to complement every system, you're assured of the highest quality products.



And with our enormous buying power, you get the lowest price.

Hardware. Software. Accessories. Supplies. At DG/DIRECT, we stock every product imaginable for your computer. From unique environmental products to supplies that have been custom designed to fit your Data General equip-



ment perfectly. All backed by a level of support that only our technically trained sales specialists can provide.

For a free copy of our latest DG/DIRECT Catalog, and to be put on our mailing list, call us today. It's the shortest distance between you and a perfect installation.

**Data General**  
4400 Computer Drive MS-1D  
Westboro, MA 01580

**1 800 343-8842**  
Supplies & Accessories

**1 800 336-9001**  
Hardware & Software

# What I did this summer

For most of us, summertime is nostalgic time. My feelings for the season are steeped in childhood memories of picnics, watermelon, no school, and long days pleasantly spent doing not much of anything. At the end of summer, whether or not there had been a climax, there was a predictable anticlimax: the puzzling task of summing it all up in an essay called "What I did last summer."

How those warm feelings about summer can persist in the face of adult reality, I don't quite understand. I usually manage to squeeze out a few weeks of vacation, but for the rest of summer it's business as usual. The deadlines and demands don't change just because the days are longer.

NADGUG's cycle of events has added a new dimension to my summertime. The summer months are among the busiest, because the pace picks up as we get closer to the NADGUG annual conference. Fortunately, NADGUG has some first-rate people taking care of the incredible amount of behind-the-scenes work that goes into preparing for the conference. If it weren't for Jan Grossman chairing the Conference Committee, Phyllis Danieli putting together the exhibit area, and Debra Bedrosian coordinating Data General's participation, I don't know what we'd do. I do know that their work is pointing the way to yet another landmark conference.

As summer draws to a close, I hope you're putting the finishing touches on your own conference plans. There's still time to save yourself some money by pre-registering, but you'll have to hurry. If you don't have a pre-registration kit, just call 1-800/877-4787 and we'll get you one. If you haven't made up your mind whether to attend, I suggest you call up your regional interest group and get the name of somebody in your area who has attended conferences in the past. Just ask them if they got their money's worth.

This year's conference falls at the very end of summer (September 18-22). Somehow, our host city of New Orleans seems like just the right venue for that season. If you've ever been there, you know it's a friendly, fun-loving city. Attendees who live in the area will be wearing special ribbons to help you spot them—and

they'll be happy to make sure you can find your way around. If sultry days and riverboats churning up and down the river outside your hotel room don't stir up summertime nostalgia, then you're due for a heart transplant!

Another NADGUG task for this summer has been getting ready for the "annual summit" meeting between NADGUG's officers and DG's top management. As I write this, we're just getting ready to schedule the meeting. Before we could do that, we had to get our agenda set—and before we could do that we had to survey our members to learn which concerns and issues should get top priority.

Those of you who filled out the member concerns survey will remember that it was a free-form questionnaire, with lots of space to say what was on your mind. Obviously, you have a lot on your mind, because the responses we got back filled 10 single-spaced pages! It's quite a chore to distill that much data into a list of priorities that we can communicate to Data General's leaders in the space of a few hours. It's worth the effort, though, because DG has been very forthcoming about the priorities we brought to them in years past. I feel confident that they will continue to act on the items we bring them.

I'm convinced that this kind of communication with DG is one of the best things NADGUG does on behalf of our membership. I'd like to close with a success story that may help illustrate what I mean.

DG introduced AOS/VS II nearly a year ago, along with a number of policy changes that proved pretty unpopular with users. Although some individual users assumed the worst about DG's motives in making the changes, NADGUG kept talking with DG and eventually found that there was another side of the story. By continuing to communicate, we finally got to the point where we understood them, and they us. DG has responded by changing one of the points of the new policy that was especially burdensome for users: you can once again order Software Subscription Service without the prerequisite Support Plus contract at each site.  $\Delta$

# FOCUS

The Magazine of the  
North American  
Data General Users Group

## NADGUG LEADERSHIP

### President:

Donald W. Clark

### Vice President:

Lee Jones

### Treasurer:

Frank Perry

### Recording Secretary:

Dennis Doyle

### Audit Committee:

Jim Siegman

### Meetings Committee:

Jan Grossman

### Membership Committee:

Bart Bates

### Planning Committee:

Joyce Carter

### Publications Committee:

Wes Thomas

### RIG/SIG Committee:

Charlene Kirian

## FOCUS MAGAZINE

### Editorial Advisory Board:

David Appel

Tim Boyer

Steve Kern

Steve Kristan

Jim Siegman

Wes Thomas

### Editor/Publisher:

Greg Farman, Ph.D.

### Associate Publisher:

Sharon Dennis

### Associate Editor:

Robin Perry

### Assistant Editors:

Geri Farman

Tricia Tighe

### Contributing Editors:

Tim Boyer

John A. Grant

George Henne

Brian Johnson

Charlene Kirian

Jim Siegman

### Contributors:

Jojo Anonuevo

Michael Cromer

Sue Dintelman

Michael Dupras

Rainer McCown

Chris Stone

### Senior Art Director:

Ann Soto

### Art Director:

Pat McMurray

### Production Artist:

Tracy Grubbs

### Production Interns:

Colleen Carroll

Craig Miller

### Production Assistants:

John Houser

### Business Manager:

Brenda Knight

### NADGUG Membership Coordinator:

Suzanne Himes

### RIG/SIG Coordinator:

Cathlene Gentry

### Marketing Assistant:

Jose F. Dimas

### Administrative Assistant:

Jennifer Foye

# THE

# Data General SOURCE

- systems
- spare parts
- cables
- upgrades
- exchanges

## Call Today!

(818)  
246-4915

Buy • Sell • Lease • Extensive Inventory

### DATA GENERAL SPECIALS

MV/15000 Mod 8 Upgrade to MV/15000	MV/10000 2MB Memory .....	\$1,500	
Mod 10 .....	MV/8000 Spare Board Set .....	1,900	
\$30,000	MV/8000 2MB Memory .....	1,100	
MV/10000 System 2MB, BBU .....	32,000	MV/8000 CPU/Chassis Cabinet .....	900
MV/4000 SC, Additional I/O Slot, 2MB,	70MB, Cartridge Tape Backup .....	7,800	MV/1400, 4MB, 70MB Disk, Cartridge
MV/20000 2nd IOC .....	8,500	Tape .....	7,000
MV/10000 8MB Memory PCB .....	5,500	6341 Mag Tape Drive (MV/2000) .....	5,500

# VERDUGO COMPUTERS, INC.

373 West Palmer Avenue / Unit C / Glendale, CA 91204  
Phone: (818) 246-4915 / Telex 662758 / FAX: (818) 246-4919

# PERFORMANCE @ LOWER COST

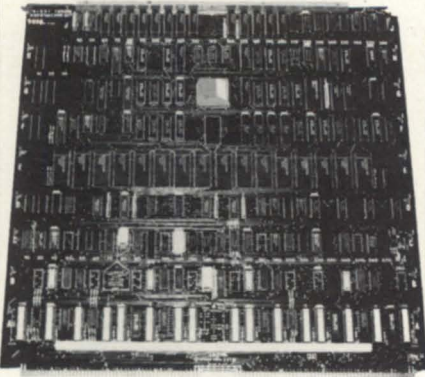

Our **IAX 16** is 100% compatible to the General's IAC 16, but that's where the similarity ends. . . the **IAX 16** offers unmatched response time, convenience and value . . .

- \* high speed CMOS based
- \* **60% faster/more traffic**
- \* emulations:

IAC16=4368/4370

IAC2-16=4368A

- \* RS232-RS422-20mA-/port
- \* a low 4.1 amps vs. 8.0
- \* power up diagnostics
- \* correct cabling detect
- \* any device code setable
- \* runs all DG diagnostics
- \* screened on board setup

The **IAX 16**, like our add-in **MEMORY BOARDS**, are performance values because we design them that way. . .

no cloning around.

**(213) 282 8700**

**SCIP**

449 So Beverly Dr Ste 201  
Beverly Hills, CA 90212

## LETTERS



### No cache in the forest

Whoa, folks. Time out. I still can't believe it after the third reading. Golly, we can't be the only DG site with cooperative maintenance.

The sentence under discussion appears on page 22 of the June issue near the end of an article titled "At Your Service" with no author attributed. I quote, "Then we read a survey from a user at the U.S. Forest Service who said 'We have a cache of DG parts which we can use to begin repairs.' Of course, stockpiling parts seems an unrealistic solution for most customers."

The U.S. Forest Service may well be

DG's single biggest customer. Many Forest Service sites have elected to participate in "cooperative maintenance" as a way to reduce maintenance contract costs and increase response time. The cache in question does not belong to the site and is not purchased nor owned by the Forest Service. The cache is property of Data General. The site is responsible for replacing any missing or otherwise unaccounted for items.

As a new member who would like to rely on your publication, I can only hope that this was a one-time "glitch."

Sincerely,  
George Parker  
Harrisburg, Illinois

### Why DG?

Reference the bulletin board from the June issue of *FOCUS*:

Mr. Weber raises a very good question, "Why DG?" Mr. Kaye also makes a very good point in his response, and this is where I would really like to do something. We, at DG, are proud of our reputation for supplying the best hardware, good architecture, and solid engineering. We are also very proud of our quality improvements.

As a corporate quality specialist, Mr. Kaye's comments of "shoddy quality control" really caught my attention. This dichotomy of "best hardware, best architecture, and pretty damn reliable" and "shoddy quality" presents us with some very good issues—issues that I believe need to be explored. To explore and ex-

pand on these issues, I would like to develop a quality survey for our users; something similar to the service survey that you conducted.

Mr. Hankins also raises a very good point, in that, unless our customers are truthful and unless they complain, there is no reason for DG to improve. I would like to have our customers help us improve those things that need to be improved. To accomplish this, we need to help define and prioritize the areas, products, and programs. DG not only wants to be known for its hardware and architecture, but we also want to be known as a high quality supplier of computer hardware, software, and services.

Respectfully,  
Jack Reardon  
Corporate Q.A. Specialist  
Data General Corporation



# A STRIKING IDEA!

## CEA'S DATA GENERAL/HOTSITE DISASTER RECOVERY SERVICES

### We Will Provide:

- Dedicated Hotsite Disaster Recovery Center with multi-state backup.
- Access to over 20 MV Class systems including an MV/20000.
- Contingency Planning Experts.
- Hardware engineers with over 200 years of experience.
- Software engineers with over 100 years of experience.
- Hotsite strategically located near Sungard and Comdisco.

Data General provides customers of CEA's Hotsite Disaster Recovery Services top priority in receiving the next available system off the line in the event of a disaster. You've spent a lot of money on your equipment and software. CEA will insure that your investment is well protected. Otherwise . . . you may *strike out*.



CEA is an authorized  
Data General  
VAR & CMO



Computer Engineering  
Associates

3922 Vero Road  
Baltimore, MD 21227  
(301) 247-5244

Circle 9 on reader service card.

## News from NADGUG and its affiliates

# See you in September

Fill out your reports,  
make your  
reservations—  
Conference '89 is just  
around the corner

It's time to start planning to attend NADGUG's Conference '89 (September 18-21 at the New Orleans Hilton), and all of the RIG/SIG activities that go along with it. In addition to the SIG meetings and the RIG/SIG luncheon, a workshop will be held for RIG/SIG leaders, organizers, and other DG users.

The workshop will be held on Monday, September 18, from 1:30 to 5 p.m. Sessions will include:

- RIG/SIG accounting
- Newsletter creation
- RIG monthly meetings/programs
- SIG workshops
- Motivational techniques—member and officer participation
- Using your RIG/SIG resources—DG participation, *Focus*, NADGUG membership.

RIG/SIG officers, individuals who are thinking about starting a regional or special interest group, or any DG users interested in finding out what all this RIG/SIG business is about, are invited to attend.

The RIG/SIG luncheon, open to all RIG/SIG leaders, will be held Tuesday, September 19, from 11:30 a.m. to 1 p.m.

This is the time when RIG/SIG reports that were turned in to the Executive Board will be presented (see details below). These reports are a good way of finding out what other groups are doing—and they are required of all recognized regional and special interest groups.

Special interest group meetings will be held on Tuesday, September 19, and Wednesday, September 20. At 5 p.m. on Tuesday, the **INFOS II**, **SIG/UX**, **OASIS (Office automation special interest subcommittee)**, **ICobol**, **AOS & AOS/VS**, and **Business Basic** SIGs will meet. At 4 p.m. on Wednesday, the **CQCS**, **PERFSIG**, and **Wordperfect** SIGs will meet, followed by the **Educators**, **Federal**, **Lions Gate**, and **Law Enforcement (LEDGUG)** SIGs at 5 p.m. Room numbers for these meetings are forthcoming.

Don't forget the fall **Executive Board** meeting! All regional and special interest groups should plan to send a representative. Your attendance at this meeting is encouraged by NADGUG officers. They not only appreciate the input from the local level, they also recruit future leaders from among the attendees. The meeting will be held on Sunday, September 17, from 9 a.m. to 5 p.m. Believe me, you don't want to miss it!

The arrival of the NADGUG Executive Board meeting means the return of RIG/SIG reports. Remember: these reports are required by NADGUG from all recognized RIGs and SIGs. All interest group leaders should receive a report

form by the second week in July. These forms should be completed and returned to me by August 1. Anyone with questions about the report should call me as soon as possible at 1-800/477-4787.

OASIS has held a number of successful workshops. This year, the group is planning to hold a workshop in conjunction with the conference. The workshop will take place on Monday, September 18, from 9:30 a.m. to 5 p.m. The cost is \$75. You can register by checking the appropriate box on the conference registration form, or in person at 8:15 a.m. the day of the workshop. Subjects will include the 20/20 integrated spreadsheet, CEO data tables, Wordperfect 5.0, and more.

The **Music and Recording** special interest group was dissolved at NADGUG's spring board meeting, but founder **Paul Duck** is trying to resurrect it. Evidently, Paul has had several calls concerning the group, and he feels it would be beneficial to give it another try. DG users who are affiliated with music and recording should call Paul at 813/577-4897.

---

*Cathlene Gentry is the RIG/SIG coordinator for NADGUG. She may be reached at Focus Magazine, 4807 Spicewood Springs Rd., Suite 3150, Austin, TX. 78759; 1-800/877-4787, (1-800/USR-GRUP).*

---

# Service. Keep it Simple with Data General.

Now you can cut through the confusing maze of coordinating service vendors.

The Compatible Products Program (CPP) from Data General Customer Service cuts right to the heart of the matter.

**Single-source service from Data General.** With CPP, you get prompt, dependable service for all your Data General products as well as a wide range of non-Data General hardware products as part of your existing Data General hardware service contract. In other words, CPP means more uptime and greater productivity.

**One toll-free call is all it takes.** When you need service, you simply dial Data General's toll-free service hotline, and you're guaranteed phone

response within one hour. And on-site response within 24 hours. It's that simple.

You can rely on one vendor—Data General—to identify and resolve system problems. And you can save time and money—because you won't have to wait for service engineers from different vendors anymore.

**The parts—and the professionals—to get the job done.** What's more, you can count on quick access to parts for both Data General and non-Data General products with CPP. As well as top service engineers backed by the resources to get your job done quickly and professionally.

So now, as a Data General service customer, you can add non-Data General products—like Fujitsu disk

drives, Genicom printers, HP laser printers, IBM PC's and many others—to your Data General On-Call service contract. Just call us with the list of equipment to be serviced, and we'll get back to you promptly with details on adding products to your contract coverage.

For the most comprehensive service available and the best protection for your investment in Data General systems, cut right to the heart of the matter. Come to Data General.

For complete information on our Compatible Products Program, call toll-free 1-800-325-3065. (In Massachusetts, 1-800-952-4300.)

 **Data General**

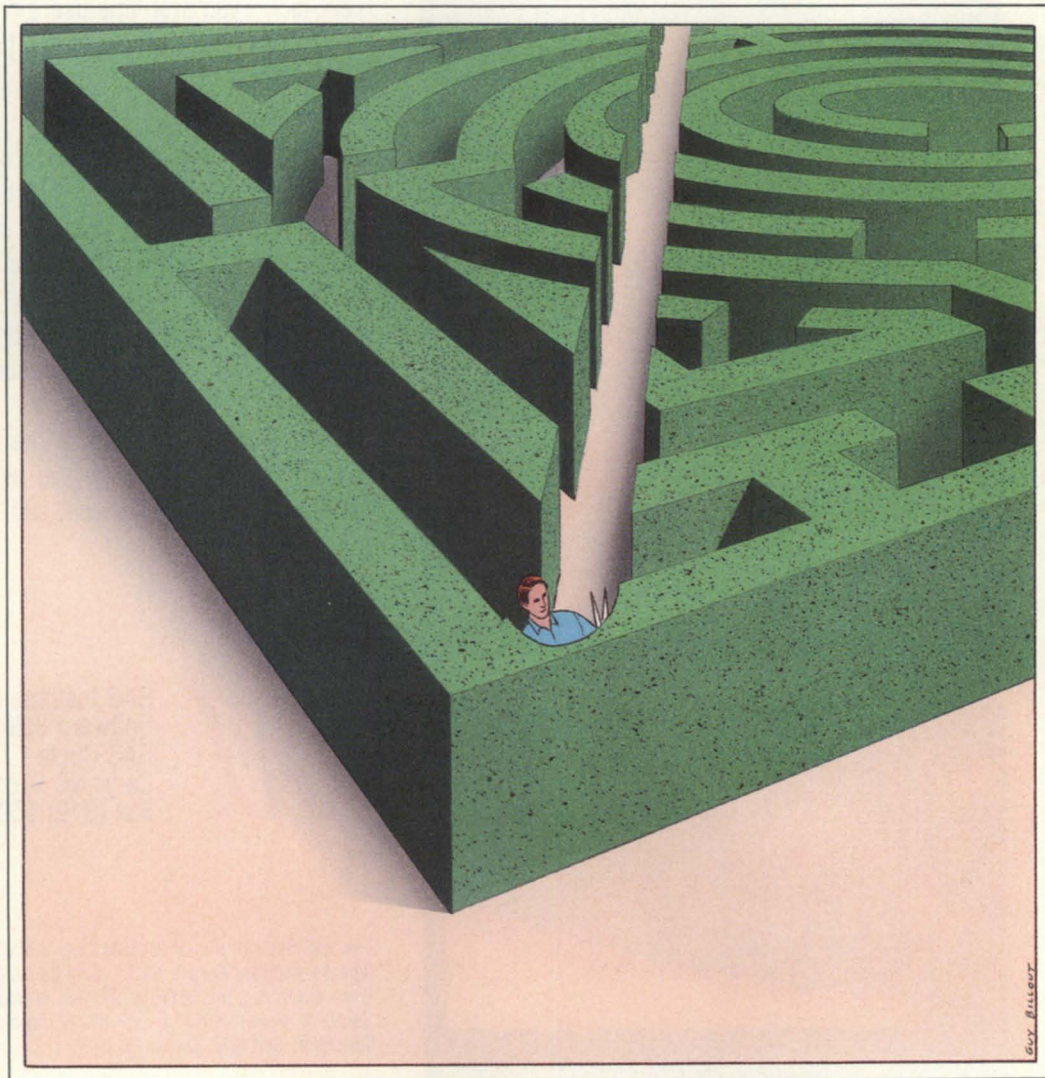

Circle 18 on reader service card.

The SAS System

# More Choices, for More Applications, than Any Other Software.

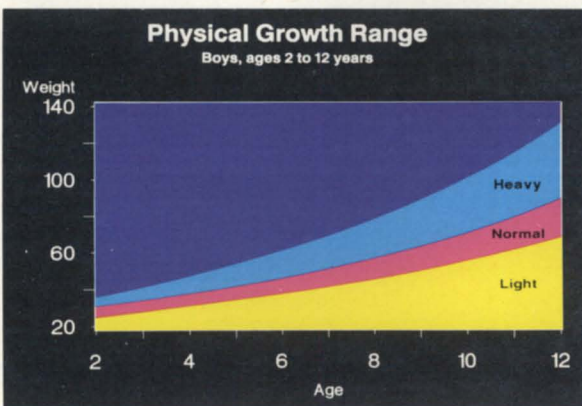
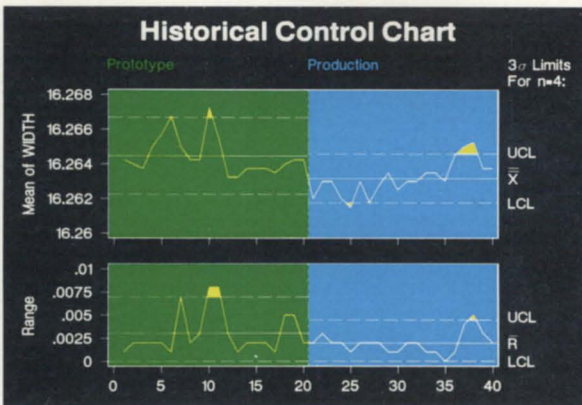
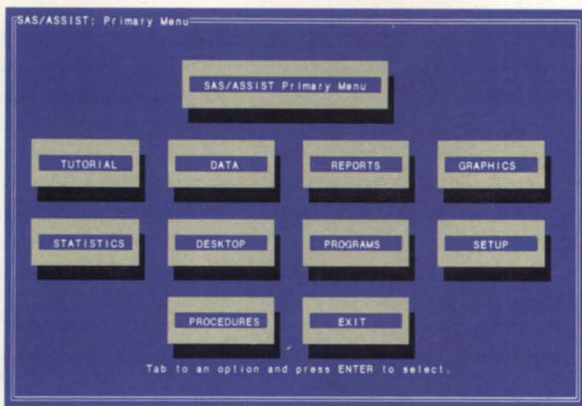

The SAS System is the software you'll never outgrow. No other software offers so many choices for data management, analysis, and presentation. For any user—new computer user to seasoned pro. For any environment—PC to technical workstation to minicomputer to mainframe.

**Choices to Build On.** Start with a powerful English-like language and essential data management tools. Then take your pick of ready-to-use applications: statistical and mathematical analysis...report writing and color graphics... project management and quality control... forecasting and decision support.

Or build your own menu-driven applications—quickly and easily—with the SAS System's interactive applications development tool. Even first-time users can command the power of the SAS System... just by filling in the blanks.

**Choices to Count On.** More than a million users throughout the world—in business, industry, government, science, and education—have made the SAS System their #1 choice for data analysis and color graphics. And every SAS System application is backed by expert technical support, documentation, and training.

We'll tell you more in a free 12-page executive summary. Just give us a call at (919) 467-8000. In Canada, call (416) 443-9811.



SAS Institute Inc.  
Software Sales Department  
SAS Circle □ Box 8000  
Cary, NC 27512-8000  
Fax (919) 469-3737

The SAS System runs under IBM Corp.'s MVS, CMS, and VSE; Digital Equipment Corp.'s VMS®; Data General Corp.'s AOS/V5; Prime Computer, Inc.'s PRIMOS®; Sun Microsystems, Inc.'s SunOS™; Hewlett-Packard's HP-UX; Microsoft Corp.'s MS-DOS®; and IBM Corp.'s PC DOS.

# Countdown to Conference '89

Patricia Seybold and Tom West are keynoters; many extras in store for attendees

This year's North American Data General Users Group (NADGUG) Conference promises to be the most exciting one to date. Set for September 18-21 at the New Orleans Hilton and Convention Center, the conference will be the largest gathering of Data General system users ever. It's the first time NADGUG has had to arrange with a convention center to get all the room needed for sessions, exhibits, and other activities. The lobby area alone is bigger than a lot of airports! Over 1,200 are expected to attend, and there will be room in the spacious exhibit hall for as many as 100 booths.

Kicking off the conference sessions on Tuesday, Patricia Seybold, president and CEO of The Office Computing Group, will give her keynote. Tom West, senior vice president, Data General's Systems Development Division, will give the Data General keynote address.

"Emerging Technologies: Changing the Challenge" is the theme for Conference '89, and is reflected throughout the conference program and exhibits. Once again, there will be something for everyone in the Data General community. Sessions will be arranged around separate "tracks" for end users, technical users, and management. Those attending will learn about recent technological advances that are changing the scene for everyone in the information business.

The exhibit area expands on the educational program of the conference by giving "hands-on" experience with the lat-

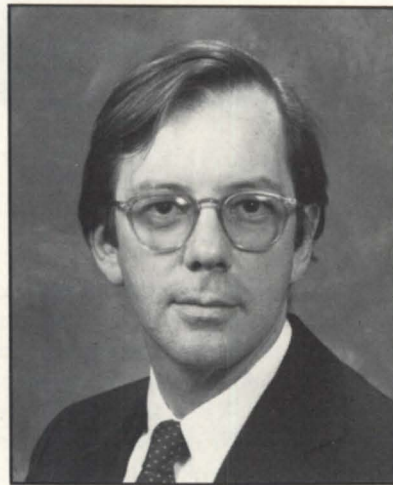

Tom West

est advances in hardware and software through displays, demonstrations, and other activities. In the Data General booth, users will learn, among other things, how DG's MV family and new Aviion systems interoperate and address the issues regarding application migration. Third-party vendor exhibits will feature everything from 4GLs, data base systems, and decision support packages, to peripherals, disaster recovery and repair and maintenance services.

Early birds can take advantage of several "extras." Educational services seminars will run on Monday, September 18 along with an office automation workshop. As a "first," the exhibit area will open Monday afternoon. On-site registration and conference materials for those who pre-register will also be available. The welcoming cocktail party Monday evening will be the first of many social



Patricia Seybold

events held in the Hilton.

Of course, New Orleans is not just for computer news. The guest program has been improved this year—so bring your spouse or a friend and let them in on the fun. Activities for guests will include tours of the French Quarter and the historic Garden District. A post conference tour will continue the fun with excursions to Baton Rouge and Honey Island Swamp, a wildlife preserve.

Speaking of registration, the pre-registration and hotel reservation deadline is August 19. Those who pre-register and are present at the General Business Meeting on Wednesday, September 20, will qualify for prizes. If you haven't received your Conference '89 registration kit, or if you need more information on the Conference or NADGUG, contact the NADGUG staff at 1-800/877-4787 or 512/345-5316. △

# User-centered computing

## SYNOPSIS

*DAA is the umbrella concept Data General is using as it works toward the goal of giving users utility-like access to computing power. This article gives a high-level overview of the approach and its benefits.*

by Chris Stone and Michael Cromer  
Special to Focus

DAA (distributed applications architecture) is a long-range model of computing that Data General is to putting in place, based on technologies like the Aviion family and DG/UX Rev. 4.1, OSI enhancements, and Novell compatibility. It involves an object-oriented approach that runs across networks built on industry standards.

DAA will facilitate integration of PCs, workstations, servers, and compute engines into sophisticated client/server environments based on industry standards, providing platforms for applica-

tions developed throughout the computer industry.

DAA is a strategy—not another standard—designed to provide computing at the convenience of the user. Under DAA, where applications (or parts of applications) are executed and where information resides will be transparent to the user.

## The role of choice

The users of information technology are united in stating their requirements for computing in the 1990s:

- They want the freedom to choose the best and most appropriate components—from any vendor—with which to build their next-generation information systems. The component elements are: workstations, applications, networks, systems, and services.

- They want vendors to provide superior architectural integration that will allow these components to operate to the best advantage in a cost-efficient manner.

Is this another way to describe open systems based on industry standards? Yes, but it must be remembered that open systems are not an end, only a means to an end. The real goal is to assure freedom of choice for the users of information technology by providing them utility-like access to computing.

As a concept, open systems is about 10

Figure 1: Distributed application

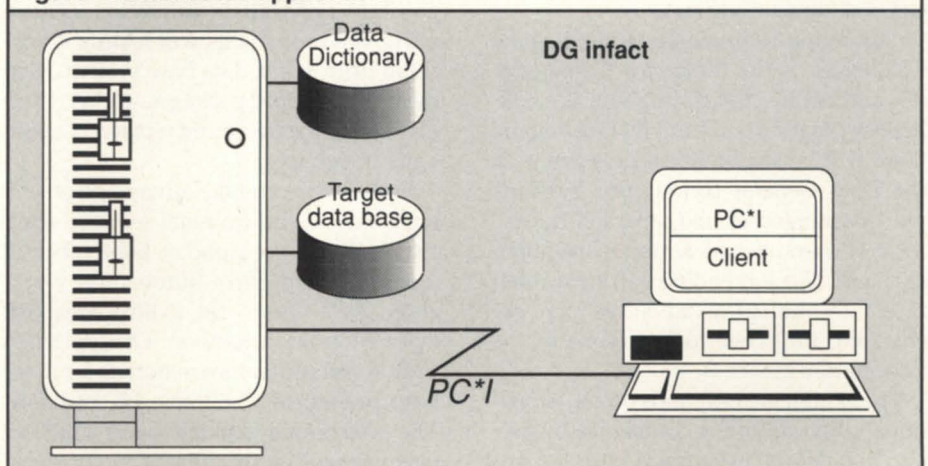



## "The Data General difference: the most comprehensive bank branch automation solutions in the business."

**Now you can have proven teller and platform software integrated with Data General's industry-leading CEO® office automation for improved customer service.**

Data General, through strategic alliances with Broadway & Seymour and Diversified Computer Products, now offers fully integrated platform and teller automation, a complete statistical management reporting system, signature verification capability, office automation, plus new teller and platform peripherals, including printers, teller transaction keyboards and PCs.

These new products let you extend the communications capabilities of your bank or savings & loan by providing more timely and accurate information such as daily rates, new product and service information and procedural or policy changes.

With CEO, electronic mail and word processing are integrated into teller and platform applications so that CSRs and tellers can access all functions from a single workstation. And, coupled with our strong peer-to-peer and host communications, branch personnel can be linked to regional and home offices.

All this with the capacity and integration that distinguishes Data General from traditional vendors, makes our approach to bank branch automation unique. Our MV/Family systems can handle all of your current requirements, as well as future applications and products at the branch level, to position you for needs that are not quantifiable today.

The result is the most comprehensive bank branch automation solution available today. With a growth capability to support your additional customer service needs now and in the future.

To learn how Data General can make a difference for your financial institution, send the coupon below. Or call: 1-800-DATAGEN. In Canada, call 416-823-7830.



# Data General

3400 Computer Drive, Dept. ADV/BASS, Westboro, MA 01580

Name \_\_\_\_\_  
Company \_\_\_\_\_  
Address \_\_\_\_\_ Phone \_\_\_\_\_  
City \_\_\_\_\_ State \_\_\_\_\_ Zip \_\_\_\_\_

**CALL 1-800-DATAGEN**

years old. It has been publicly embraced by nearly every vendor in the industry for at least five years, but progress from concept to reality has been all too slow. It might appear to the users that vendors say one thing, and do another.

Open systems could arguably be compared to governmental deregulation such as occurred in the transportation and communications industries during the

1980s in the U.S. It may be good for the consumer, but difficult for many, if not most, of the entrenched vendors. Strategies based on a captive market become obsolete. Vendors who can adapt quickly to a market of free and open commerce survive the transition and prosper, while others will not fare so well.

There is a striking difference, however. Governmental deregulation occurred at

the whim of Congress and with the stroke of a pen, while the future of open systems is in the hands of the vendors and users, and can only be brought about by the pressures of the market.

Progress depends in large measure on an enlightened user community. Ten years ago, the knowledge base was concentrated in the hands of a very few specialists. Today, every executive and manager must be keenly aware of the role of information technology in the future of his or her division or department. Technology news flows freely at all levels of the organization, and millions have joined the technology watch.

#### User-centered computing

Twenty years ago, when Data General was founded, computing was still largely a *machine-centered* process. The cost of computer processing was enormous by today's standards. The economics of computing dictated that users stand in line for access to the mainframe. Delivery of information processing could be said to be at the convenience of the machine.

Data General, Digital, and others, introduced minicomputers that downsized the packaging and reduced the cost of computing to the point where users had direct access to the machine. The changing economics made it possible for the value of the user's time to be part of the model. This era, time-sharing, could be called *user-directed computing*.

Ten years ago, another generation of change began, based on microprocessor and VLSI technology. The scale, packaging, and cost of computing shrank to the point where each user could literally have a dedicated machine. Again, the economic model changed, and we saw the beginnings of *user-centered computing*. We believe that PCs and desktop workstations, even when connected by networks to each other and to the larger hosts, do not completely fulfill the promise of user-centered computing. Outside of workgroups sharing file servers, the majority of workstations today are little more than peripherals of larger systems.

The information base still resides largely on traditional hosts. Workstations serving the hosts are needed to talk to the user. And much of the information users need is in the public domain, not easily accessible via either the host or directly.

The computer industry describes the

## Why Join NADGUG?

### Reason #12

# Find Them Fast

The member directory is a complete guide to NADGUG members. It provides an easy way to make direct contact with DG users who have the same system uses, software, or equipment configuration as you. It's easy to use and best of all comes free with your NADGUG membership! The member directory contains five sections, a main directory which is organized by company name and contains detailed user infor-

mation, and four cross references: individual name, state, operating system and major language. The directory allows you to find a NADGUG member by name, or area; or to find that member who is working with the same type of system you are!

It is easy to let your fingers do the walking through the NADGUG member directory.

To receive your free copy, become a member of the North American Data General Users Group today!

**NORTH AMERICAN  
DATA GENERAL**  
**USERS  
GROUP**

1-800-USR-GRUP

512/345-5316 (outside U.S.)



# Finally... An AOS/VS Performance Seminar for Normal Humans.

Brian Johnson is leading three-day seminars covering the basic principles of AOS/VS performance analysis & capacity planning. The minimum prerequisites are 6 months of experience as an AOS/VS System Manager or System Programmer, and access to a performance analysis utility such as **PERFMR** or DG's **MONITOR**.

Schedule:	
Oct 16-18	San Francisco
Feb 12-14	San Francisco

Call for a registration kit, or for on-site seminar information.

## :SYSMGR

Software for System Managers  
A Division of B.J. Inc.

109 Minna Street, Suite 215  
San Francisco, CA 94105 (415) 550-1454

Circle 61 on reader service card.

## FULL SCREEN EDITOR

- Works with most CRTs
- Easy to learn and use
- On-line help
- User definable function keys
- Demo package available

AOS, RDOS, AOS/VS . . . . 600.00  
Demo version . . . . . 25.00

## COMPUTEK LTD.

5707 113 A STREET  
Edmonton, Alberta  
Canada T6H 1A7

**403/436-1842**

Circle 8 on reader service card.

# CSR

Computer Systems  
Remarketing Corp.

**WE BUY, SELL & TRADE  
THE COMPLETE LINE OF  
DATA GENERAL EQUIPMENT**

**CALL US FIRST AT:**

**(804) 262-3555**

**FAX (804) 262-4270**

8603 Sanford Drive  
Richmond, Virginia 23228

Circle 10 on reader service card.

## PopTerm

Memory-Resident  
Hot-Key  
Terminal Emulator  
D410 and  
40 other CRTs

## PC/VS

The High-Performance  
LAN-Based  
PC Integration  
Alternative

*Now Novell-Compatible!*

## Solutions

**for Every  
PC Integration  
Problem**

Call for your free copy of the  
RDS Report on PC Integration

## PC/Mail

CEO-Compatible  
PC-Based  
Electronic Mail

*New!*

## PC/Remote

LAN Functionality  
Using just a Modem  
or Direct Asynch  
Connection



**Rational Data Systems**  
150 South Los Robles Avenue  
Suite 410  
Pasadena, California 91101  
Phone: 818/568-9991  
FAX: 818/568-9990

Circle 50 on reader service card.

current architecture as client/server computing, but that is essentially the computer industry talking to itself. It really refers to access to personal data and applications at the convenience of the user, but it is not yet utility-like.

To differentiate this from what's coming, true user-centered computing not only distributes processing power to the desktop, but also redistributes the way in

which machine cycles are used. Ten years ago, the majority of machine cycles were expended to process and compute data. Tomorrow, the vast majority of all machine cycles will be expended to support the user's interface to the information. As graphical user interfaces become more important, the ratio will favor the user even more dramatically and the architectural base of DAA will be in place.

### From client/server to DAA

The goal of user-centered computing should be to place information and processing power at the convenience of the user, with network-based applications distributed optimally throughout.

- First, this will take best advantage of the customer's choices of applications, networks, systems, and services.

- Second, it will allow systems and networks to be scalable, eliminating the large step-fixed costs of growth that characterize the mainframe and time-sharing architectures.

There are two activities needed to reach this goal.

*The first step is a new way for designing applications.* We have already begun to introduce this model into our MV family systems, by providing support in the underlying operating and networking software, and by exploiting this capability in our business automation and data base management systems. DSA, PC/WS, DG/Infact, SQL/DBMS, etc., are just a few examples (see Figure 1).

At the same time, we have begun, with the 88Open, to provide more advanced applications development systems, in which workstations will be clients of many servers, and applications and services will be transparently distributed throughout the network. In the Aviiion family, the network itself becomes a backdrop for distributing all services to the desktop and the user.

Our distributed applications architecture will employ Unix servers to provide essential services such as authentication, directories, gateways, and systems management. These servers will also stage the basic components of workgroup computing, such as shared filing systems, mail, and time management.

As we have previously stated, user-centered computing implies that users of information technology must be able to choose the applications, networks, systems, and services that are appropriate to their computing needs, whether from Data General or any other vendor. A critical component is the workstation itself. It is our intention, therefore, that DAA will support the use of all major workstation platforms—not just the Aviiion workstation—including the Intel architectures running DOS or OS/2,

**In the defense industry, complex data has presented challenging data management problems. 3CI's InFoCen has the ability to rapidly populate and analyze engineering datasets for decision-making support.**

Performance is a design issue at 3CI. The relational table structure utilizes bit-mapped cross reference tables to provide instantaneous query response. Multiple loading options are available up to 1000 records per second.

Every RDBMS vendor promises top performance. InFoCen delivers performance through unequalled analytical throughput and comprehensive system features.

**See it Perform today.  
Call 1-800-525-2001**

## 3CI InFoCen<sup>®</sup>

Compatible with VAX-VMS, DG-AOS/VS,  
DPS-GCOS8, CDC-VSOS.

2057 Vermont Drive, Fort Collins, CO 80525

## Performance 3CI InFoCen<sup>®</sup> RDBMS/4GL

*"I looked at the top systems... and there were no comparisons when it came to speed and flexibility."*



Dave C. Moon  
Senior Software Engineer

Ultrasystems  
Defense and Space, Inc.

Circle 63 on reader service card.

other workstations running Unix, and the Macintosh.

The second critical activity for advancing DAA involves the actual user environment. As our strategy is revealed, our customers will see specific actions in each of three areas, which we define to be the key technical ingredients of a distributed applications architecture (see Figure 2):

- Common user environment
- Open networking
- Distributed object management

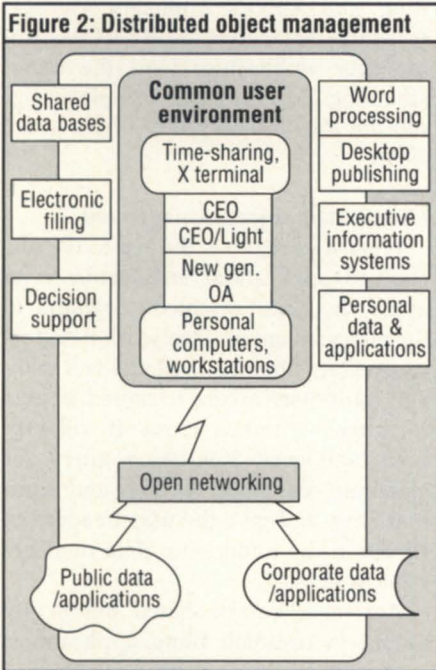

**Common user environment**

In a world of user-centered computing, a common user environment is an essential prerequisite. It gives the customer the power to deploy computing resources effectively throughout the organization. It reduces training costs and minimizes lost productivity. Consistency across heterogeneous platforms will eliminate a major obstacle to implementing utility-like access to computing.

Conversely, the user interface is the most visible part of the system and the most obvious opportunity for product differentiation. The vendor is clearly in a difficult position if freedom of choice for the customer is in conflict with marketing objectives. Thus, we have vendors who proclaim support for a standard user interface—across their own product line.

In light of this, the recent action by the

Open Software Foundation to select the user environment component (better known as the OSF/Motif) must be seen as a major victory for the customer. To identify and resolve this controversial issue in barely six months is an unprecedented event in the history of computing.

Data General applauds and wholeheartedly supports the OSF decision to adopt the merged Hewlett Packard/Mi-

crosoft and Digital offerings as the UEC standard. We see this result not only as offering freedom of choice for the Unix community, but also the way to unify three of the four standard workstation platforms: Unix, DOS, and OS/2 (with the fourth being, of course, Macintosh). We have already begun the process of making the OSF UEC part of the standard graphical user interface for future

# NEW & IMPROVED!

## DG Color Graphics Terminal Emulator for IBM Micros.

Comprehensive products spanning the entire Dasher Terminal Line. \$95 to \$195.

Terminals Emulated	Graphics Boards	File Transfer	Bonus Features
D470C	VGA	XMODEM	Compressed Mode
D461	EGA	Kermit	70+ Macro Keys
D411	HERCULES	File Capture:	Auto Dial
D920	MCGA	• Text	Auto Logoff
W460	CGA	• Binary	Unlimited Config. Files

# EMU/470™

Version 2 Now Available

- Higher Speed • Same Low Cost • Free Support
- Volume Discounts • Technology Leader



**Rhitek, Inc.**  
 P.O. Box 220  
 Columbia, Maryland 21045  
 301-730-2575

VISA and MC accepted.

Circle 52 on reader service card.

product offerings, including our office systems for Unix-based servers.

We believe that standardization of the user environment should go even further, to include an object-oriented model, such as that found within Hewlett-Packard's New Wave architecture. From this, distributed access to information will cause users to think in terms of information, not processing, and that is the crux

of the fourth wave.

**Open networking**

Support of the leading industry standards, together with the evolution of an ISO-standard core network, has always been an important part of Data General's networking strategy. For the Aviiion systems, we have demonstrated TCP/IP connectivity, and have announced sup-

port for IBM's SNA. It is important for many of our customers to know that ISO is an essential component of Data General's strategy. When they are ready to implement ISO, we will be there to provide it.

At the same time, we recognize that many other users have implemented workgroup computing using networks other than TCP/IP, SNA, or ISO. Therefore, we will be expanding our support of industry-standard networks to include defacto-standard workgroup networks, such as Novell's Netware, IBM's Token Ring, and Apple's Appletalk. We also recognize that the Microsoft 3-COM LAN Manager architecture (and the corresponding LMX for Unix) will play a significant role in workgroup LANs in the 1990s.

**Distributed object management**

What we believe is the key to the distributed applications architecture is to apply the object-oriented paradigm to the management of all network-based resources. An object data model will manage multi-user access to stored objects for truly distributed access. It will support high-level, SQL-based query for elaborate searching, sorting, and summarizing, and give the user freedom of choice in the underlying data management system.

Any object can be shared among any other services (mail, filing, applications, ...) providing for a common method of management and security. Attributes about these objects will be defined once, and inherited throughout the distributed system. Dynamic modification will be accomplished, facilitating the design of new programs, and applications from existing ones.

The object-oriented view is simply a method of reducing the complexity of large systems without placing additional overhead on smaller systems. Object orientation provides the transparency that is needed to achieve a truly open and user-centered computing model.

**The fourth wave**

Data General's vision of computing for the 1990s is in a very real sense built upon the unification of our distributed object technology with the technologies pioneered by ourselves and others during the 1980s:

**Only The Best For Your DG System**

*The disk subsystem that sets the standards*

**FOR YOUR  
MV COMPUTER  
Argus 623X Emulation  
SKS-HP Plug and Play Series**

**FOR YOUR ECLIPSE &  
NOVA COMPUTERS  
Zebra Emulation  
SKZ-XX Plug and Play Series**



- Up to 1200MB (formatted)
- Only 3.5" vertical rack space
- 5.25" SCSI-interfaced drives, which offer longevity, high reliability, large capacity and a small footprint
- 10.7 msec average seek time (40% faster than DG's 6239 Argus)
- 4.0MB/sec transfer rate

- Up to 620MB
- 5.25" SCSI-interfaced drives
- Only 3.5" vertical rack space
- 18 msec average seek time
- 1.25MB/sec data transfer rate

**ZETA** Authorized Stocking Distributor

For Back-up:

**The Helical-scan Cartridge Tape Subsystem**  
2 Gigabytes on a small 8mm cartridge



- High reliability
- Compact Media
- Uses host resident tape drivers and back-up utilities

**Dataproducts Printers**

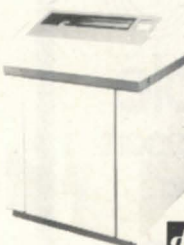

**LB Series  
Band Printers**  
(DG Models 4595, 96/  
4598, 99)  
4 models: 300, 600,  
100, 1500LPM

**LZR Series Laser Printers**  
(DG Models  
6474-6479)



LZR 1230 — 12ppm  
LZR 1260 — 12ppm PostScript  
LZR 2630 — 26ppm PostScript

**Dataproducts** Authorized Stocking Distributor

*Also: complete line of accessories & supplies*

*Your First Choice for DG solutions*

**interscience**  
COMPUTER CORPORATION  
5171 CLARETON DRIVE, AGOURA HILLS, CALIFORNIA 91301

Call  
**(800) 627-2007**

Circle 40 on reader service card.

- Sun and Apollo in technical computing
- Microsoft and Novell in personal computing
- Data General and others in department computing.

By merging the technologies into a single, network-based, object-oriented model, we will achieve a goal that has long eluded business management. DAA will be a unified work environment for all types of users. Gone will be the artificial distinctions between technical users and business users, and all will become part of a high-performance team.

All of these technology components under the DAA umbrella have immediate benefits for the three groups Data General is most interested in serving directly:

**Independent software developers.** They are eager to write software and sell it inexpensively to fill a variety of end-user computing needs. They now feel the 88000 market will be large enough to absorb their products and give them a profit. They also know, from the PC experience, that software may be demanded in quantities that allow for shrink-wrap-type distribution.

**Value-added resellers.** VARs can construct a hardware/software/communications package that can be sold across several industry categories or into specific industries using industry-standard hardware, software, and communications components. They've seen the advantage of this in the PC era but have also seen customers restrained from getting the performance they demand by high prices; in addition, the open networking component will allow them to add valuable, and profitable, services that are just not possible today.

**End users.** Whether handled directly, through VARs, or with the help of ISVs, these are the people demanding utility-like access. In larger companies, the resulting systems will expand on the strategic uses of computers already begun. In

*Chris Stone is group manager of software for Data General and executive director of the Object Management Group, an international organization devoted to making computer systems and software from different manufacturers work together. Mike Cromer is a product manager for Data General.*

smaller companies, users can begin to afford the strategic use of computers. Companies will communicate with their customers and their suppliers; all will have access to public information and services.

Data General believes that end users want utility-like access to computers. End users also want to know that the company that provides the technology,

whether it is their direct supplier or not, is of sufficient strength to offer technically superior products, worldwide if necessary, backed with service, training, and continuing product refinement.

Of the major computer companies in the world, Data General believes it stands out from the crowd with the resources committed to a pure, user-centered, open computing model, DAA. △

## REORGANIZE DISKS IN PLACE,

without dumping to and re-loading from tapes, with the

# DISK\_PAK™

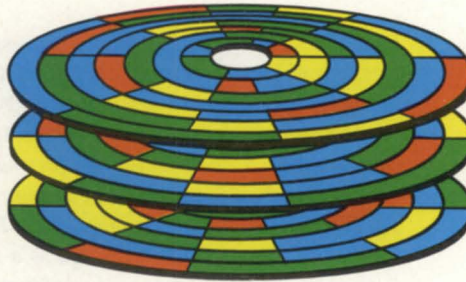

### Before reorganization:

Directory information, frequent files, and available space scattered throughout the disk. High average seek distance and poor performance.

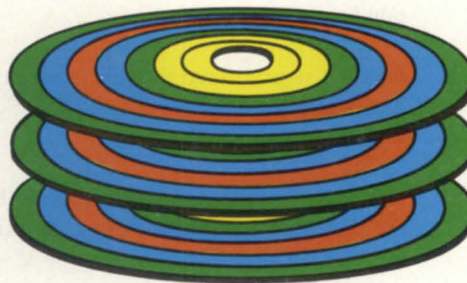
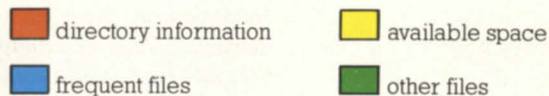

### After the DISK\_PAK:

Directory information and frequent files clustered on a few cylinders, available space made contiguous. Low average seek distance and improved performance.

## EAGLE Software, Inc.

P.O. Box 16 / 169 E. Cloud  
Salina, Kansas 67402-0016

**(913) 823-7257**

**FAX: (913) 823-6185**

**DISK\_PAK** is a trademark of EAGLE Software, Inc.



Circle 32 on reader service card.



# ata base update

## SYNOPSIS

*Data General's strategy for data base management is to offer a suite of DG products that is thoroughly integrated with both the MV and Aviiion series, and to make sure that all popular third-party products are readily available to their users. Why and how they're accomplishing this strategy is highlighted in this interview with Mike Normile.*

*Sometimes even the most innocent question catches a person off guard. In the case of Mike Normile, the innocent question was, "What is your title?" Normile's answer was typically candid: "I don't know. We just had a reorganization so I guess I'll have to make one up. How about Group Manager, Data Base Products?" Starting ten years ago as a systems engineer, Normile has graduated through a variety of product marketing positions with Data General. Now part of the corporate marketing team, he is responsible for Data General's own data base products, as well as for the company's overall strategy in the area of data base management and fourth generation languages.*

**Focus:** I would have thought your position would now be part of the new Software Business Unit.

**Normile:** I work closely with them, but the distinction is that the Software Business Unit has two functions: one is setting policies and procedures in the general area of software; they are also responsible for negotiating contracts with third-party vendors, maintaining the account relationships with the vendors, and acting as product managers for those third-party products. Corporate marketing retains responsibility for specific DG label products, whether those products are built in-house or purchased outside, as well as being responsible for the overall strategies. Part of my job is to identify for the Software Business Unit what are

the important data base products to have available on the Aviiion series. It's then their responsibility to go out and make that happen.

**Focus:** A few years ago it was fashionable to debate the merits of relational vs. hierarchical vs. network data base management systems. We don't hear very much about these ideas any more. Is that because a consensus view has emerged?

**Normile:** Yes. There is a consensus view: relational won. And not only relational, but SQL as a particular implementation of the relational model. The war is over, and it was an unambiguous victory for the relational concept.

**Focus:** But doesn't Data General still offer products that correspond to the hierarchical and network models?

**Normile:** The products are still out there because they all have existing customers. Once a product's been on the market for a while, it builds up an installed base. Just because new customers—or existing customers building new applications—are moving over to newer products doesn't mean you pull the plug on the old products. After all, we introduced a new model 16-bit computer last year, because we still have an installed base of customers running with those older products and we're certainly not about to abandon them.

**Focus:** In addition to offering your own data base products, DG has marketing relationships with a number of companies that sell their own data base management software. Why support so many different approaches?

**Normile:** It can at times become complex, but the market seems to demand that variety. If you look just at the data base software vendors that are concentrating on the mid-range and PC markets, you have three or four of them that are each producing over a hundred million in annual revenues. Oracle, RTI, Unify, Informix, Cognos, Progress . . .

# AOS/VS & ORACLE

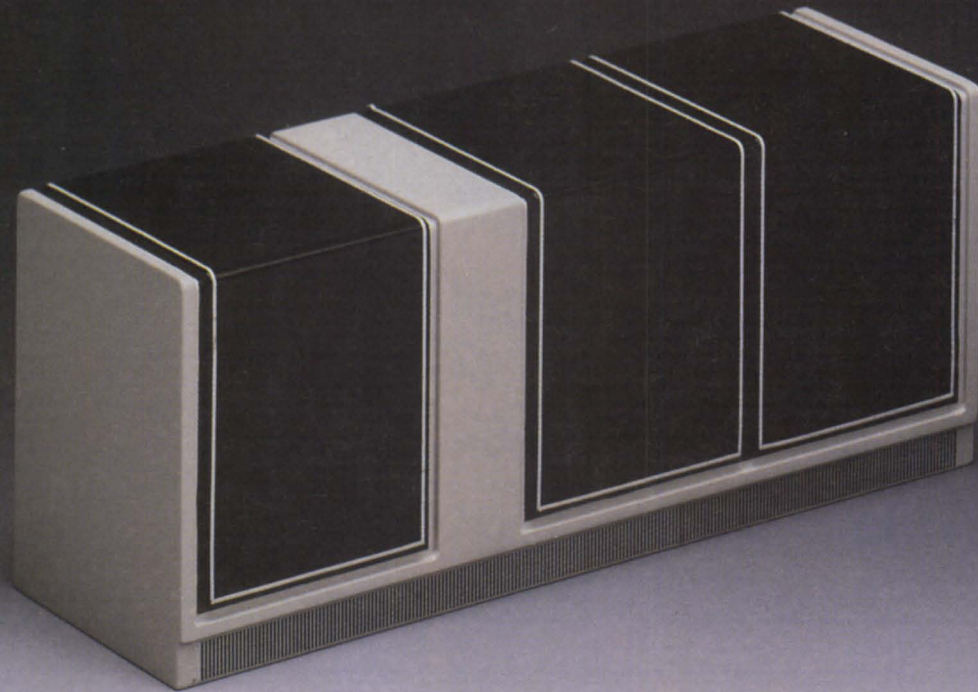

**A**OS/VS was the best-kept secret in the world. Now, with the ORACLE® RDBMS, your MV applications treat data located on virtually every other micro, mini and mainframe as if it were a local database. In addition, your MV applications are now portable to every other computer in your company. How?

Because ORACLE is SQL, compatible with both the IBM and ANSI standards.

Because the same ORACLE applications run unmodified on

mainframes, minis and micros.

And ORACLE is the best performing RDBMS under AOS/VS.

All these things have made Oracle Corporation not only the world's fastest growing software company, but the third largest software company on the planet.

Register for the next free ORACLE seminar in your area. Why keep AOS/VS a secret? Connect to IBM and DEC systems and show them what a *real* power user can do. Let AOS/VS on your Eclipse shine. With ORACLE.

## ORACLE®

COMPATIBILITY · PORTABILITY · CONNECTABILITY

Call 1-800-345-DBMS, ext. 3326 today.

Copyright © 1989 by Oracle Corporation  
ORACLE is a registered trademark of Oracle Corporation. AOS/VS and Eclipse are registered trademarks of Data General. IBM and DEC own numerous registered trademarks.

20 Davis Drive, Belmont, CA 94002 • World Headquarters (415) 598-8000 • ORACLE Canada (800) 387-4407 (except Quebec) • Quebec (514) 337-0755 • ORACLE Systems Australia 61-2-959-5080 • ORACLE Europe 44-1-948-6911 • ORACLE Systems Hong Kong 852-5-266846

### U.S. CONFERENCES

AL	Huntsville	Oct 11k
	Mobile	Sept 7f
AR	Little Rock	Sept 7
AZ	Phoenix	Sept 14k
	Scottsdale	Oct 10af
CA	La Jolla	Oct 19f
	Los Angeles	Sept 19k Oct 12g Oct 17f
	Newport Beach	Sept 28f Oct 26f
	Ontario	Oct 3f
	Pasadena	Sept 12f
	Sacramento	Sept 21f
	San Diego	Sept 21af Oct 10g
	San Francisco	Sept 28 Oct 26
	Santa Clara	Sept 28am Oct 19f
CO	Colorado Springs	Oct 24
	Denver	Sept 1u Oct 19f/2k
CT	New Haven	Oct 12m
	Stamford	Sept 12m
DC	Washington	Sept 12g Oct 17g
FL	Boca Raton	Oct 18f
	Miami	Sept 20f
	Tampa	Sept 6f/k
GA	Atlanta	Sept 13k
HI	Honolulu	Sept 14f/p
IA	Des Moines	Oct 18
ID	Boise	Oct 12f
IL	Chicago	Sept 14g Sept 20af Oct 25f/k
	Springfield	Sept 7
IN	Fl. Wayne	Sept 14
	Indianapolis	Oct 17a
KS	Wichita	Oct 12
KY	Lexington	Sept 19
LA	New Orleans	Sept 20k Oct 20f
MA	Boston	Oct 24a
	Framingham	Sept 7f
MD	Baltimore	Oct 17k
MI	Dearborn	Sept 5f/p
	Grand Rapids	Oct 13f
	Troy	Oct 10f
MN	Minneapolis	Sept 12f/m Oct 11ak
MO	Kansas City	Sept 20a Oct 3g
	St. Louis	Sept 12af Oct 10ak
NC	Charlotte	Oct 27f
	Res Tri Park	Oct 26p
NH	Bedford	Sept 6
	Merrimack	Oct 4
NJ	Iselin	Sept 12m Oct 10f
	Saddlebrook	Sept 9f Oct 19f
NY	Albany	Oct 11k
	Amherst	Sept 14f
	Liverpool	Oct 18f
	Melville	Sept 20f Oct 18p
	New York City	Sept 13f Sept 27k Oct 11 Oct 25f
	Rochester	Oct 19k
OH	Cincinnati	Oct 5p Oct 24g
	Cleveland	Sept 12m Oct 25k
	Columbus	Sept 14 Oct 3
	Toledo	Sept 7
PA	Harrisburg	Oct 19
	King of Prussia	Oct 13k
	Philadelphia	Sept 5g Sept 25p Oct 24f
	Pittsburgh	Sept 20k Oct 17p
SC	Charleston	Oct 26f
	Columbia	Oct 19k
	Greenville	Oct 12f
TN	Memphis	Sept 19k
	Nashville	Oct 24k
TX	Austin	Sept 29f/p
	Dallas	Sept 7f Oct 3f/k
	Fl. Worth	Oct 16f
	Houston	Sept 21o Oct 19f/p
	San Antonio	Sept 28f/p
UT	Salt Lake City	Sept 7k
VA	Richmond	Sept 21f
VT	Burlington	Oct 19
WA	Bellevue	Sept 20
	Spokane	Sept 26
WI	Milwaukee	Sept 12f Oct 24k

The following key indicates additional afternoon seminars that are offered with these seminar dates:

- a Macintosh Networking
- f Oracle Financials
- k CASE/Application Tools
- l Oracle Mail
- m Computer Integrated Manufacturing
- o On-line Transaction Processing
- p PC Product Solutions
- u Unix

Please note:  
g Seminars held for Federal Government only.  
\* Only the afternoon seminar is held that day.

### CANADIAN CONFERENCES

For registration call (800) 387-4407, except in Quebec, call (514) 337-0755.

Calgary	Sept 14
Halifax	Sept 26
Ottawa	Sept 7 Oct 12
Montreal	Sept 6
Quebec	Sept 27
Regina	Sept 2
Vancouver	Sept 14 Oct 11
Victoria	Sept 21
Winnipeg	Oct 12



**FREE:**  
**Mastering ORACLE**  
by Dan Cronin.

Pre-register for the conference by calling the 800-number on the left, mention the name of this publication and you will receive a certificate at the conference, entitling you to a free copy of the \$24.95 book that has no-nonsense answers to today's pressing MIS and development issues.

FOCUS MAG

TRBA

## ETHERNET TCP/IP NETWORKING For All DG SYSTEMS

- Industry standard TCP/IP LAN connections for AOS/VS, AOS and RDOS systems.
- Connects DG systems to non-DG systems such as VAX, IBM-PC, SUN and APOLLO.
- High speed file transfer using the standard FTP protocol.
- Virtual terminal remote logon using the standard TELNET protocol with VT100 terminal emulation.
- Supports ECLIPSE/MV, ECLIPSE, NOVA and DESKTOP systems.

### CLAFLIN & CLAYTON, Inc.

117 Maynard Street, Northboro, MA 01532

**(508) 393-7979**

FAX 508/393-3169

Circle 5 on reader service card.

## INFODEX PRESENTS CONVERSION PLUS™

Moving from one Data General to another or between different vendors has become far easier with CONVERSION PLUS.™ Now, transfer between data media and upgrade your software—all through Infodex, the Data General experts.

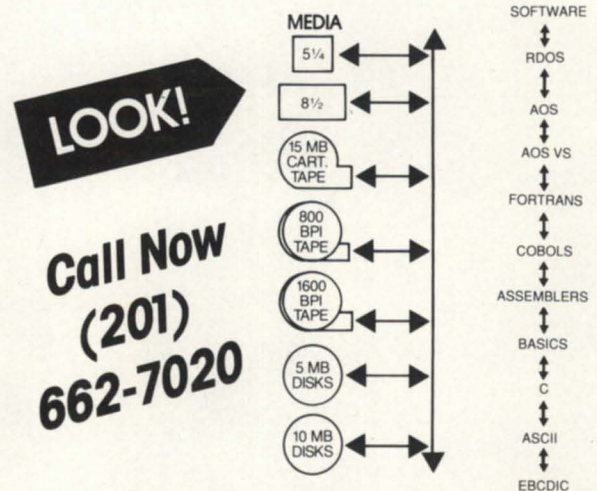

### INFODEX

7000 Boulevard East • Guttenberg, NJ 07093

Circle 38 on reader service card.

# ? ! #

## Hook-Bang-Crunch

The Definitive Manual on CLI Macros

Liberalily spiced with meaningful, practical and immediately usable examples, all of which are available on Mag-Tape.

### Special Features

- Correct use of PUSH, POP & PROMPT POP
- [!STRING]-less string variables
- Writing your own Pseudo Macros
- Avoiding 'CLI out of memory' errors
- Numeric and Alphanumeric input validation
- Complex Logic with 'AND' & 'OR'
- Initial IPC Macros
- [!FILENAMES .. ] with switches
- Appendices on SORT/MERGE & SPEED

For OPERATORS, PROGRAMMERS, SYSTEM MANAGERS and USERS

PRICES	\$US	\$A
?!# Manual	\$80-00	\$100-00
?!# Mag-Tape	\$80-00	\$100-00
Shipping / Handling	\$15-00	\$5-00

### INTRODUCTORY OFFER

- Tape free with orders of 2 or more Manuals
- Free delivery with all orders
- Valid only for orders received by 31 August '89 (Format: 222pp A4, 3-hole drilled, Binder not supplied)

## Shalless Software Pty Ltd

(incorporated in Victoria)



P.O. Box 469, Malvern  
Victoria 3144, Australia  
Tel: (61-3) 640-1756  
Fax: (61-3) 696-4928

Send order with Cheque or Money Order

(allow 4 to 6 weeks for delivery)

Circle 57 on reader service card.



they're all well established. The market seems to be saying we need a variety of these products, and the market is supporting that variety with its dollars. Who are we to tell the market it's wrong, and it only needs one or two products?

**Focus:** When you identify a software product by a third party that you would like to have hosted on to DG, what do you do to make that happen? What kind of promises do you have to make? Do you often have to modify existing Data General products?

**Normile:** To answer your first question, there is no answer to your first question. Just about every deal is different. Sometimes we approach them, sometimes they approach us. If you're talking about an existing product that is running on some other type of hardware, certainly up until now that has always involved a port to bring a product to the MV family architecture under AOS/VS. If you read the articles and speeches that have come from Data General executives concerning our 88K strategy, it should be clear that part of the motivation for the strategy was to simplify this process. In the past it did require a port to acquire third-party software for the MV—often a fairly complex port—and given Data General's size it was sometimes difficult to get software vendors to undertake that port. Now, with the 88K and Unix standards-based strategy, there will still be ports to be done, but you're now talking quick, easy, and simple ports.

Since we are part of the 88Open consortium, and since we are supporting the 88Open binary compatibility standard, when someone ports to Data General 88K, they're also porting to everybody else's 88K. The attractiveness to the Data General platform is magnified by that. Two things will be working in our favor: first, the ports will be easier, and second, the person doing the ports will be addressing a much larger market than they would with an MV port. There is just no question that it is a lot easier to get software vendors to do an 88K port than an MV port.

**Focus:** When Data General announced the Avion series, it also said it is going to aggressively try to bring in applications. Obviously, data base management is one

of the areas in which you would like to get the applications. At this point, can you give us a rundown of the products that are available on that platform?

**Normile:** We have signed a number of contracts, and there will be public announcements forthcoming over the next few weeks. Back in February, when the 88Open software initiative was an-

nounced, there were 26 vendors that had either signed a porting contract with the 88Open software initiative, or who had written a letter of intent to support the 88K architecture and the binary compatibility standard. The data base products among that list included Cognos with their Powerhouse software, Informix, Pick (which is sort of a combination of operating system and data base software all

# GENISYS I <sup>TM</sup>

## OFFICE INFORMATION SYSTEM

Our customers built these applications in days,  
not months!

<ul style="list-style-type: none"> <li>Sales Tracking</li> <li>Real Estate Transactions</li> <li>Political Contributions</li> <li>Survey of Felon Sentencing</li> <li>Customer Calls</li> <li>Inventory Management</li> <li>Legislative Tracking</li> <li>Maintenance Schedules</li> <li>Library Catalogue</li> </ul>	<ul style="list-style-type: none"> <li>Mailing Lists</li> <li>Litigation Support</li> <li>Project Management</li> <li>Telemarketing</li> <li>Bacteriology Register</li> <li>Asset Management</li> <li>Employee Census</li> <li>Field Service Dispatching</li> <li>Document Tracking</li> </ul>
---	--

These are a few of the applications created by marketing specialists, accountants, paralegals, clerical staff, personnel officers, research assistants, office managers and other non-technical computer users. With GENISYS you can develop comprehensive, customized solutions—stand-alone or integrated with WordPerfect Office<sup>®</sup> or CEO.<sup>®</sup> And you can have GENISYS for as little as \$4,000 on any CPU!

Try GENISYS Today!  
1-800-284-8333

DMS Systems, Inc.

---

Advanced Software Solutions 1111 Brickyard Road, Salt Lake City, Utah 84106  
(801)484-3333 FAX (801)484-3367

WordPerfect Office is a trademark of WordPerfect Corp. CEO is a registered trademark of Data General Corp.

Circle 31 on reader service card.

# Data General Sales and Repairs

✓ BUY ✓ SELL ✓ LEASE ✓ REPAIR ✓ SERVICE

- New and used systems
- CPU's, Disk Drives, CRT's, Printers
- Compatible peripherals, Terminals
- Full service depot repair
- New England on-site maintenance

**HANSON**  
DATA SYSTEMS INC.

Data General's only  
Single Source Second Source

734 Forest St., Marlboro, MA 01752  
508-481-3901  
800-225-9215 (Outside Mass.)  
508-460-0593 (Fax)

**DATARAM**  
AUTHORIZED DISTRIBUTOR

Circle 36 on reader service card.

**u'til'ity** (yoo-til'i-te)n., pl. -ties 1. The quality or state of being useful. 2. For Data General users, CAI utility software.

**em'u'lation** (MATE) - offers DG MV users a powerful and versatile async terminal emulation and file transfer package.

**en'cryption** (File Crypt) - offers encryption and decryption of AOS/VS & CEO files to provide data security.

**fax** (RUSH) - auto-dial facsimile delivery package from any DG terminal.

**mail** (Pipeline) - offers AOS/VS users an efficient and versatile mail and delivery package.

**menu** (menuOP) - provides a user friendly menu interface in a secure environment for AOS/VS users.

**search** (Text Scout) - find any word, phrase or text string contained in CEO or WordPerfect documents.

**trans'fer** (FileMover) - move ASCII and binary files between systems at speeds up to 9600 baud.

**va'ri'e'ty** (call CAI) - for info on other utility software to *Make Your Job Easier*.



**Concept Automation, Inc.**

*Turning Concepts into Reality...*

**(703) 450-6000**

Circle 13 on reader service card.

rolled into one), Progress, Relational Technology, Unify, and maybe one or two others. Most of these folks are quoting late 1989 for having their ports available.

I want to clarify that DG's overall strategy for both the MV series and the 88K has two parts. Part one is to have a suite of Data General label products thoroughly integrated with the DG product line, both hardware and software. That's true for the MV family today and it will be true for the Aviiion product line in the future. For data base management this will include DG/SQL and DG/Ingres. DG/SQL is not going to be BCS compliant; it's going to take advantage of every relevant extension that we've built into DG/UX to be well integrated with our multiprocessing hardware architecture. For that reason, we believe it will be the best performer on DG hardware.

Part two is that there is a wide variety of popular third-party products on the market and it's our intention to bring as many of those to our customers as we can. As a practical matter, there will be more of those products on the 88K than the MV. On the 88K we're confident that our customers will have a choice of all of the third-party products. I think it will become the standard.

I would like to add that standard Ingres, like other data base products on the market, consists of a relational data base and a collection of tools and utilities that, taken together, comprise a fourth-generation language. With DG/Ingres, we have an agreement between Data General and Relational Technology (the company that produces Ingres) to jointly split that package. We have taken their 4GL tool set, split them off and ported them first to the MV under AOS/VS, and built a gateway so that they use DG/SQL as their underlying data base. DG/Ingres is a 4GL; the combination of DG/Ingres and DG/SQL comprises a data base package sold and supported by DG.

**Focus:** What provisions are you making for current users to migrate their applications on to the new RISC platform?

**Normile:** Number one, the MV lives. I'm very serious about that because as soon as you start talking about migration strategy, some people tend to get a bit nervous and think the sky is falling, and that is not the case. By no means is Data Gen-

eral telling people that they must migrate; this is not something that will force them off of their MVs. We had a whole round of high-end MV announcements late last year, and we have had a lot of low-end announcements so far in 1989. That is going to continue.

We have also told people that new generations of MVs will be sharing a lot of technology with the 88K machines. Data General is providing a lot of mechanisms to allow customers to interoperate MVs and 88Ks. In other words, you can hook them up on the same network and exchange data back and forth in a variety of ways—from common magnetic tape formats, to common communications protocols, to remote access agents similar to what you now have on MV systems.

There will be guidelines for writing new applications that can be ported easily—we hesitate to use the word “automatically,” because there are so many differences between the Unix world and the MV world. If someone decides that they want to migrate for whatever reason (and it won't be because Data General is trying to force them to migrate) there are various ways to do that. What it is going to take and what products might be available to assist in that will depend an awful lot on the particular application—what software products it uses, whether it does things like make direct operating system calls, whether it has assembly language code embedded, and so on. The more the particular application is tied to the specifics of the MV architecture and/or AOS/VS, the more effort such a migration might require.

In the data base area, I know one thing we have stated publicly is an intention that DG/SQL and DG/Ingres will be made available on the 88K.

**Focus:** Is that guideline for people writing new applications available now?

**Normile:** It has been made available to specific customers. It is not published, but it could be a subject for consultation with your friendly local Data General sales rep.

**Focus:** So much has been said about the advantages of fourth generation languages, but it's apparent that the second and third generations are still far from dead. Are the 4GLs eventually going to

# SAM 2010

## ENVIRONMENTAL SECURITY SYSTEM

### INTELLIGENT / POWERFUL / SENSITIVE

MONITORS computer room environment and PROTECTS your computers (DEC-VAX, microVAX, PDP/II, DG-MV Series, IBM 370, 4300 and others) from environmental hazards. **ABLE** to monitor multiple stations, alert users, telephone key people and conduct orderly system software and power shut-downs if nobody responds to alarms.

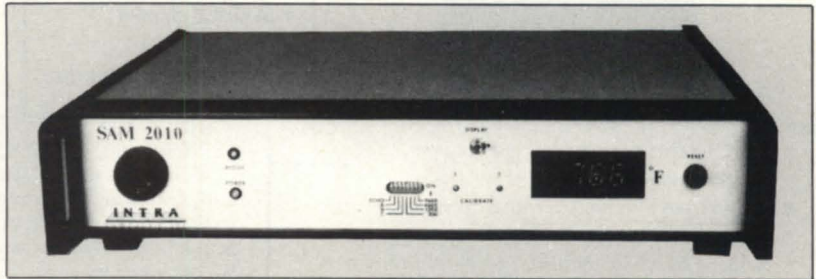

**PROTECTS** Your Computer, Programs, and Data Against:

- Air-Conditioning Failure
- Smoke / Fire / Water / Assault
- Excess Temperature, Humidity
- A.C. Power Irregularities

**BETTER THAN AN INSURANCE POLICY,  
SAM-2010 AVERTS DISASTER BEFORE COSTLY DAMAGE OCCURS**

Only the **SAM2010** system does all the above, **AUTOMATICALLY** when measured values exceed pre-set limits. 24 hours a day. No coffee breaks. No vacations.

**THE COST — LESS THAN YOU THINK**

TO FIND OUT MORE ABOUT THE **SAM2010** SYSTEM, WRITE OR CALL —

Distributed by:

**VANTAGE SOFTWARE, INC.**

555 W. 57th Street, 11th Floor, New York, NY 10019  
(212) 956-2240

Circle 68 on reader service card.

## Don't Walk.....



**.....to the nearest FAX**

**Now.....the greatest thing to hit the office since word processing. With RUSH any AOS/VS user can send a Fax anywhere in the world. With a few key strokes, you can send WordPerfect, CEO or AOS/VS documents. You decide who can Fax, when to Fax and where to Fax. You create alias and group names. You turn logging on for reports and billing information. To find out more, send us a Fax (703/430-6185) and we'll RUSH you a reply, or call...**



**Concept Automation, Inc.**

**(703) 450-6000**

Circle 12 on reader service card.

# SCREEN DEMON

Pop-up  
Windows

For  
COBOL!

- Electronic Mail
- Pop-up Calculator
- Print Screen
- Pop-up Notepad
- Redraw Screen
- Swap to CLI
- Faster Screen Display

- View screens of programs running on other terminals
- Record and playback terminal sessions
- Automatic termination of inactive program
- Remote termination with orderly shutdown
- WP Library and CEO interfaces
- ACCEPT time-out for ICOBOL

Versions for AOS/VSCOBOL and ICOBOL work with existing programs without recompilation. Screen Demon routines may be called from programs written in "C".

**\$950**

Demo available \$25

**Threshold, Inc.**  
165 E. Magnolia Ave.  
Auburn, AL 36831

**(205) 821-0075**

Circle 65 on reader service card.

## CALLING BBasic USERS

### B32 reaches the parts BB cannot

B32 not only outperforms BBasic, but also can be ported to 386 via UNIX/XENIX platform. Please write or call for a demonstration copy. Alternatively we will install a parallel system.

#### We also offer:

Consultancy, Computer Audit, Bureau Services, Resource Accounting, Capacity Planning & Disaster Recovery.

#### Solutions for:

PC Integration  
Full Office Automation  
Please ask for Phil or Tony

### Robson & Deakin Ltd.

Computer Consultants      Phone: **061-794 8080**  
Brierley House              Telex: **668424**  
Bridge Street                Fax: **061-794 7754**  
Pendlebury Industrial Estate  
Swinton  
Manchester M27 1FJ

Phil Robson: 02602 76488    Tony Deakin: 0937 73446

Circle 53 on reader service card.

dominate the marketplace as was predicted several years ago?

**Normile:** That's a little difficult to answer, and it depends on your definition of 4GL. Certainly 4GLs are coming into wider and wider use, both in the types of applications and the size of applications undertaken using 4GLs. We're also seeing more and more mixtures using 4GLs on some parts of application systems. I might start off by prototyping with the 4GL, then reimplement the performance-critical portions of the application in a 3GL. I would still continue to use the 4GL for less performance-critical portions of the application, as well as for ancillary portions such as ad hoc reports, charting, and things of that nature. Four-GLs are still being used pretty much exclusively in commercial applications like decision support, departmental processing, and so on. Three-GLs still rule the roost for applications that require higher performance.

As for the future, people are talking about CASE tools and being able to generate applications from some type of specification pseudo language. Whether that will involve 4GLs or 3GLs, or whether it will somehow magically just go from spec down to executable object image, is an open question. Even in environments like that, I think you'd still see 4GLs used for things like ad hoc reporting and queries. It will be an interesting evolution. Of course, all the 4GL vendors are busy either building their own CASE tools or integrating their 4GLs with CASE tools. If the promise is realized, for a certain class of applications, CASE tools will obviate user-written or user-visible code altogether.

**Focus:** In general terms, is there any advice that you could give to typical MV users who are going to be interested in taking advantage of the best technology that will be available in a few years?

**Normile:** Anything I could say in a few words would be misleading. It depends so much on the particular customer's situation. Data General is conscious of the issue and is prepared to sit down with any individual customer and come to a mutual understanding of what their needs are and where we are going and how to best match those two things up.    Δ

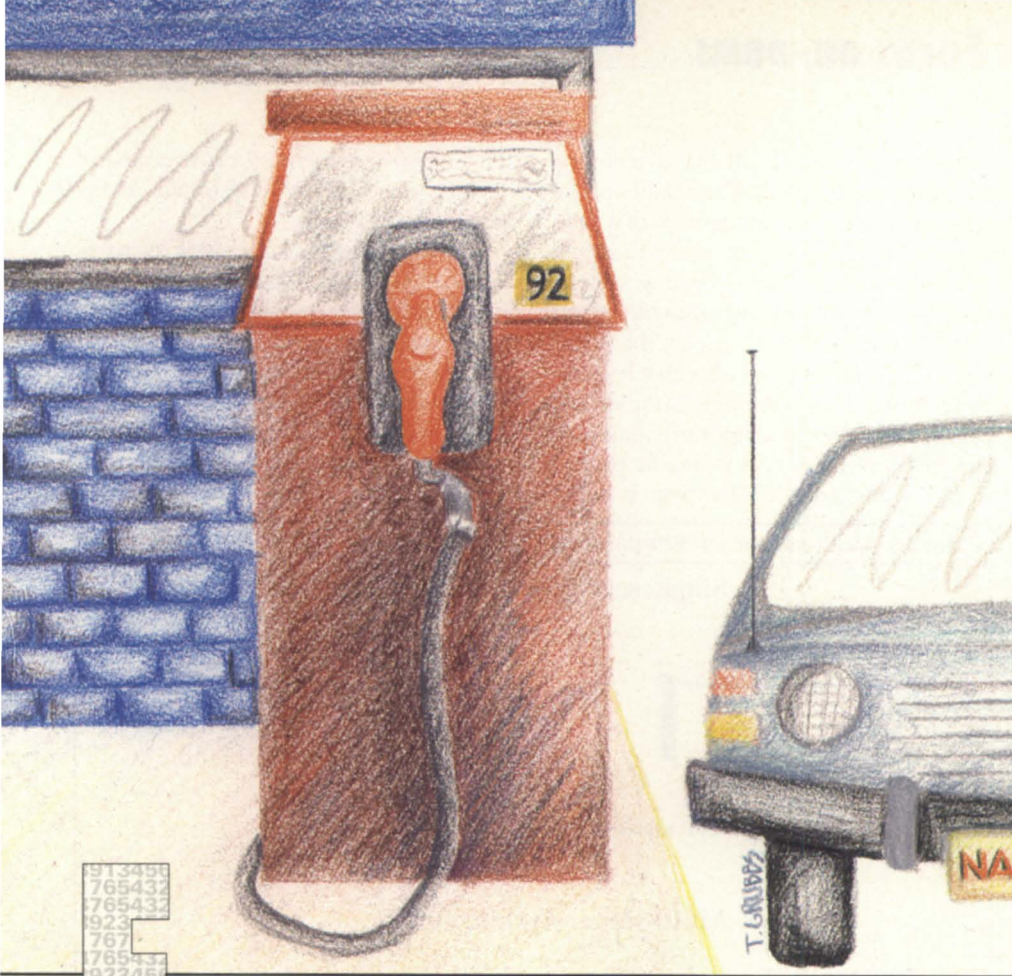

923456  
765432  
765432  
923  
767  
76543  
923456  
76543  
766  
923  
765  
923  
923

# Full-service or self-service?

**SYNOPSIS**

*The efficiency with which a particular server architecture manages interactions should be a key consideration of the DBMS buyer.*

by Jojo Anonuevo  
Special to Focus

Many data base management system (DBMS) vendors claim that their data base products perform better, but, as far as I know, none have tried to explain exactly what makes their systems faster. While all benchmarks show performance improvements over earlier versions, some vendors compare their results to those of others. These numbers provide a means of comparison, but the prospective buyer should take heed in evaluating these numbers. Many factors affect performance, and benchmarks may not be standard. A thorough understanding of

DBMS architecture can provide a better means of evaluating performance.

**Key considerations for DBMS buyers**

Virtually all DBMS vendors use some form of server architecture. Two types of server architectures exist: single-server and multi-server. In order to understand the differences between the two models, let's consider the processes involved in a data base transaction.

First, a user inputs information into an interactive application. Then the application program acts upon the user's request and calls the appropriate DBMS functions in order to access the data base. The user application is often referred to as the

"client," and the DBMS that fulfills the request is called the "server." System performance can be greatly affected by the interaction between these two components. Therefore, the efficiency with which a particular server architecture manages this interaction should be a key consideration for the DBMS buyer.

**Advantages of single-server architecture**

As its name implies, the single-server model consists of a single process that is responsible for all data base operations. The server process performs all the necessary data base operations on behalf of the clients in a serial fashion. In this architecture, the server resembles a multi-tasking operating system on a uni-processor computer. The server schedules data base requests similarly to the way that the operating system schedules processes on the CPU. Therefore, the server process must be fast and efficient in order to service hundreds (or even thousands) of simultaneous client requests.

Inherent in this design is the ability to protect the data base from invalid access that may lead to data base corruption. Since all data base requests go through the server, users are prevented from writing directly to the data base. This creates a controlled environment in which users are protected from each other.

Another advantage of the single-server architecture is its simplicity. Having a single point of control gives the server the ability to efficiently coordinate user requests. In some systems, the server can execute client requests based on priority. In this case, the server acts as a gatekeeper, allowing those clients with the highest priority to be processed first.

**Drawbacks of single-server architecture**

There are several drawbacks to this design. The most critical flaw deals with

# Why gamble...

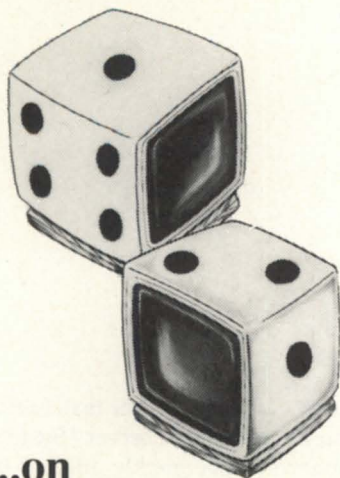

...on  
someone offering  
disaster recovery  
as a sideline?

With DG/hot site from  
Data Assurance, you get:

- Dedicated DG computers
- Dedicated Communications
- Dedicated Recovery Experts

Over 100 DG users, spanning  
the U.S. and Canada, don't  
gamble with their information  
based assets - or their choice  
for a hot site. They use the  
dedicated people, experienced  
in actual recoveries and hun-  
dreds of tests, and dedicated  
disaster recovery resources of

## Data Assurance Corporation

Denver • New York • Philadelphia

**(800) 654-1689**

6551 S. Revere Pkwy, Englewood, CO 80111 • (303) 792-5544

Data General has qualified DAC as a provider of  
DG/hot site, based on criteria established by DG.  
DAC is an independent company offering its  
disaster recovery services to users of

**DataGeneral**  
equipment.

Circle 15 on reader service card.

## FOCUS ON: DBMS

something inherent in all virtual memory systems—a page fault. Page faults occur when a single page or segment of a program is not resident in main memory during execution. The operating system resolves this situation by calling the page handler routine, which copies the missing page from disk and allocates it space in memory. This seemingly simple task causes the server to temporarily halt execution. Since the server is unable to perform its function while the page is being

This minimizes memory contention and enables the CPU to concentrate on the single-server process.

Most multi-tasking operating systems, such as AOS/VS, allow users to assign priorities to processes. It is crucial then, on a single-server DBMS, that the server be assigned a high enough priority so that it is not interrupted by a higher priority process. If this situation occurs, the server process would be forced to wait until the other process finishes executing

Figure 1: Multi-server vs. Single-server Architecture

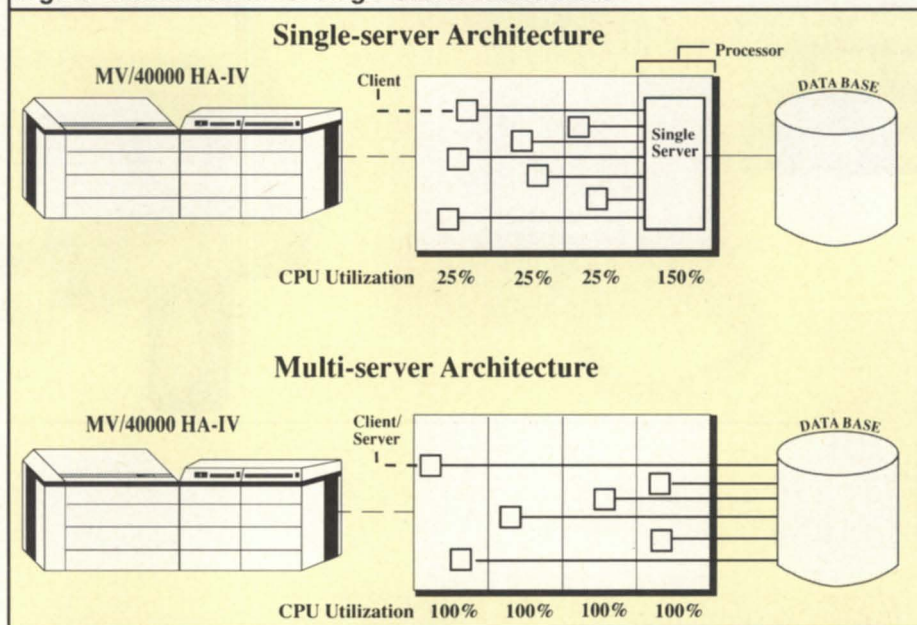

retrieved, all client requests will wait until the operating system completes this operation. Clearly, such delays lead to significant performance degradation.

Depending on system load and the size of memory, the situation described above can occur frequently. For example, the server may be executing a client request when it realizes that it has to call on the error handler routine to return an error. The error handler tends to be used infrequently, and is therefore not resident in memory. A page fault occurs and the operating system suspends execution of the server process. It may either execute another process or execute the page handling routine to resolve the page fault.

Keep in mind that while this is happening, all client requests are queued behind the current request. DBMS vendors that subscribe to this architecture often recommend that clients dedicate a computer to the server and have end-users networked to the dedicated server.

or suspends execution for other reasons.

In addition to operating system priorities, the administrator of the single-server DBMS has to contend with DBMS client priorities since the data base server has its own scheduling algorithm and priority mechanism. Moreover, since all data base requests are executed by the single-server process, the operating system sees all client requests as being the same priority. Balancing system priorities can be a daunting task for the DBA.

Another drawback to the single-server architecture deals with the most recent trend in computer architecture. Hardware vendors, like Data General, have introduced new machines that allow for two or more processors instead of the conventional single-processor CPU. The Data General MV/40000 HA Series computer allows for up to four processors to be configured. This allows for greater processing power since CPU execution is no longer limited to one processor. With

**STRENGTH, STABILITY, LONGEVITY**  
**EXCELLENT WORKMANSHIP COMMITTED TO SERVICE**

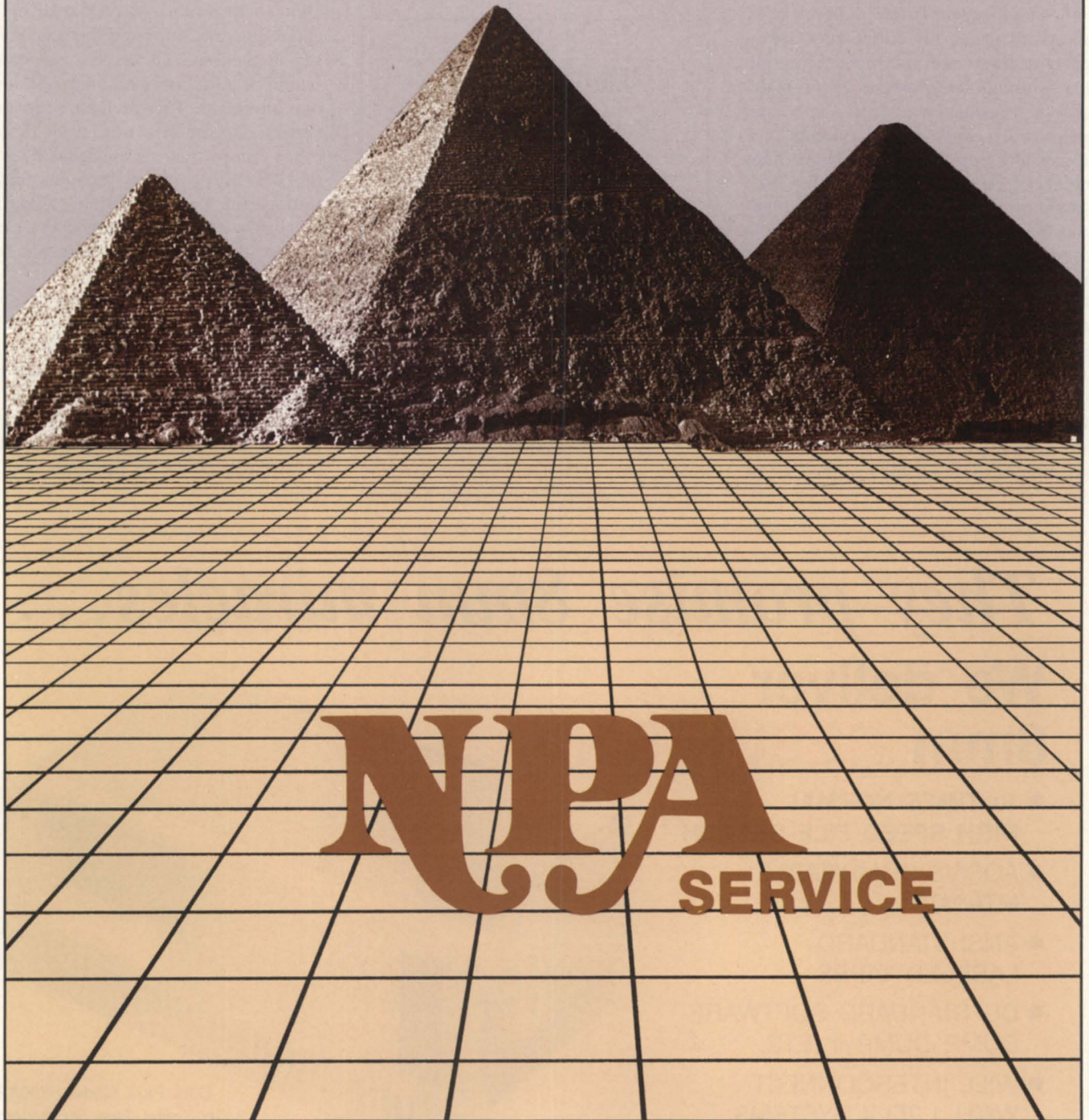

**Service, Sales, Facility Management/Recovery Site and Software**  
**We cover your Data General & PC needs from coast to coast**

**EAST COAST MAIN OFFICE:**

**NPA Systems, Inc.**

761 Coates Avenue, Holbrook, New York 11741  
(516) 467-2500 • FAX: 516-467-5609

**WEST COAST MAIN OFFICE:**

**NPA Systems of California, Inc.**

2323 Fourth Street, Berkeley, CA 94710  
(415) 848-9835 • FAX: 415-845-1665

symmetric multi-processing systems, queued processes can be executed on any available processor, minimizing CPU resource contention and providing higher throughput.

The single-server DBMS does not take full advantage of the added processing power of these new machines. Since all data base requests are executed by a single process—the data base server—only one processor is capable of executing this process at a time (see Figure 1). Adding another processor can only minimize CPU contention, allowing for uninterrupted processing of the data base server. Data base clients are still required to wait while the server works on a client request. Single-server DBMSs are intrinsically unable to take advantage of the true power of these new machines—parallel computing.

### Multi-server architecture

In a multi-server DBMS architecture, each client executes a copy of the DBMS server. This enables every client process

to perform data base operations. It also resolves the bottleneck problems that plague the single-server architecture. Some DBMS vendors have designed their servers so that the code is re-entrant.

The multi-server architecture relies on the highly efficient scheduling algorithm provided by the operating system

Therefore, only one physical copy of the server is necessary to service multiple users. AOS/VS shared memory allows for one copy of the DBMS server to reside in memory while clients execute as single

independent processes.

A multi-server DBMS can be compared to a self-service gas station. The clients are the cars needing gas and the servers are the drivers of the cars. Each server is allowed to pump gas on behalf of the client (his car). Applying this analogy to the single-server DBMS, the gas station would be a full-service station with only one attendant. The attendant can only service one car at a time even though other pumps may be available. Clearly, the self-service station provides higher throughput. Even if the single attendant efficiently attends to more than one car at a time, he still has to divide his time among two or more cars.

The single-server DBMS duplicates much of the work performed by multi-tasking operating systems. A lot of code is written to provide an efficient scheduling mechanism to prioritize client requests. The multi-server architecture relies on the highly efficient scheduling algorithm provided by the operating system.

# *They promise 8mm miracles...*

## **We deliver 8mm RESULTS!!!**

- 10 TIMES NORMAL HIGH SPEED FILE SEARCH
- AOS/VS COMPATABLE MTA/MTC
- ANSI STANDARD LABELED TAPES
- DG STANDARD SOFTWARE DUMP, DUMP II, ETC.
- WILL INTERCONNECT WITH 1 TO 4 SYSTEMS

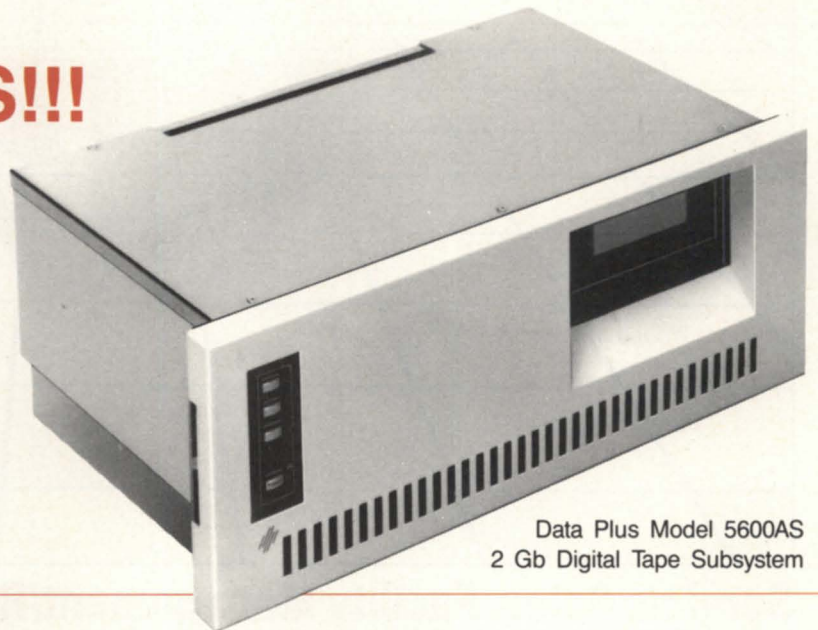

Data Plus Model 5600AS  
2 Gb Digital Tape Subsystem



### DataPlus

2750 Oregon Court, M3  
Torrance, CA 90503  
(213) 618-2090 • Fax (213) 618-8714

*“nobody does  
it better”*

Circle 20 on reader service card.



As explained earlier, the single-server architecture suffers from the complicated dual priority system. In most multi-server DBMSs, clients and servers execute as the same process. Therefore, process priority affects which users get most of the data base resources. The DBA can assign higher priority to users accessing the data base through an interactive application and lower priority for a batch report that queries the data base. There is no need to assign another level of priority since the operating system is capable of scheduling the client/server process based on its user-defined priority.

Unlike the single-server DBMS, the multi-server DBMS takes full advantage of multi-processor machines such as the Data General MV/40000 HA Series computers (see Figure 1). Some vendors have claimed 95 percent scalability of their multi-server DBMS products in multi-processor environments. That is, adding an additional processor resulted in a 95 percent increase in the number of trans-

actions per second.

Much of the increase in performance can be ascribed to the server architecture and the high concurrency resulting from row-level locking capabilities. Since multiple servers are able to access the data base, each processor can be executing a data base process—thus providing real parallel processing. Extending the gas station analogy, the processors would be the gas pumps. By adding more pumps, more cars can get serviced since the drivers (servers) are no longer limited to one pump.

It is also important to point out that with a multi-server architecture, page faults do not prevent the DBMS from continuing its task. When a page fault occurs during execution of a client request, the processor simply services another data base request. The page fault causes only one user to wait, but does not prevent other clients from executing their data base requests. This is true for all multi-server DBMSs running on a single or multi-processor system.

**Row-level locking**

Locking granularity also plays a key role in DBMS performance. Since multiple clients will be accessing the data base, DBMS servers must be able to handle resource contention efficiently. Among the resources shared by relational DBMS (RDBMS) users are tables and rows. For example, employee information for John Smith of XYZ Corporation may be stored in a table called EMPLOYEE. Therefore, a record (or row) of John Smith exists in the EMPLOYEE table. At any given time, two or more users may be trying to update this record or other records of the EMPLOYEE table. For this reason, RDBMS vendors have implemented locking strategies to preserve data base integrity and enable users to simultaneously access data base information.

All RDBMS servers use some form of locking strategy. However, it is the level or granularity of locks that affects the degree of data base concurrency and performance. Virtually all RDBMS vendors

# HOW FAST IS B32?

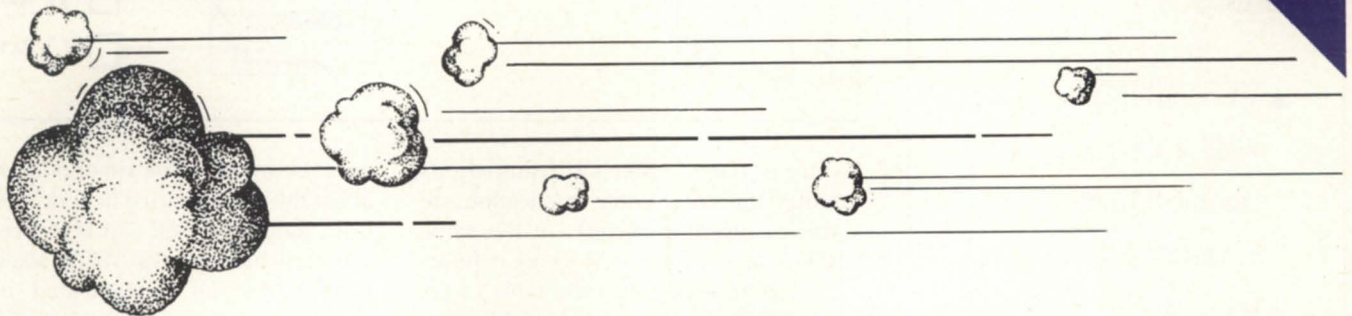

**NOW AVAILABLE FOR UNIX**

# WANT TO SEE IT AGAIN?

There's no doubt about it. B32 is fast. So fast, it runs your programs 70-100% faster than Data General's Business BASIC.

But that's not all. B32 brings you more of everything: program size, statements and variables.

B32 gives you the flexibility to add the latest features: Windowing, Wordperfect, CEO Integration, and Shell programming.

Best of all, B32 is easy to install, works just like your Business BASIC does now, and is backed by the best support in the business.

Call now for your free, full function B32 demonstration tape.

**MAXON**  
COMPUTER SYSTEMS INCORPORATED

**(212) 227-1922**

575 Madison Avenue  
Suite 1006  
New York, New York  
10022

85 Scarsdale Road  
Toronto, Ont., Canada  
M3B 2R2  
Fax: (416) 445-6228

U.K. Agent:  
SYNERGISTIC SOFTWARE COMPANY LTD.  
Hughenden House, Main Street  
Collingham, U.K. LS22-5AY  
Tel: 09 37 73446 Fax: 09 37 66903

Circle 44 on reader service card.

# For a smoother sailing upgrade 7800 7800XP



## and a better end result.....

... specify SCIP memory and IAX16's when you upgrade to an MV7800 or MV7800XP  
... @ 1/2 the +5v power usage plus lower cost—the SCIP duo allows you to add more than the "limit" of IAC(X)'s in your chassis yet increases overall reliability by reducing heat. They're easy to install and are 100% DG compatible too.

▲ MV780/MV780X memory  
4 MB, 8 MB, 10 MB sizes  
enable/disable switch  
lifetime warranty

▲ IAX16 /IAX16A  
RS232 or RS422  
runs all DG diagnostics  
21% faster thruput

**(213) 282 8700**

**SCIP**

449 So Beverly Dr Ste 201  
Beverly Hills, CA 90212

Circle 55 on reader service card.

## FOCUS ON: DBMS

offer page-level locking, but some provide even more granularity with row-level or record-level locking. With page-level locks, users updating information contained in the same data block (or page), are forced to wait until one of the users releases the lock. Note that users may be updating different records in the block, but page-level locks limit access to a given data block to only one user (see Figure 2).

Most updates or changes to the database occur in the form of an entry or insert into the data base. For example, orders may be entered in an order-entry application and inserted into the ORDER table.

level lock is required for every row being updated. Therefore, users trying to update information contained in the same data block will no longer be required to wait, as long as they are updating different rows. In the scenario described above, multiple users may simultaneously insert records in the same data block without any delay. This provides a higher level of throughput and makes the data base accessible to more users.

### The truth about performance

Most vendors agree that benchmarks are useful tools in evaluating perform-

Figure 2: Page-level vs. Row-level locking

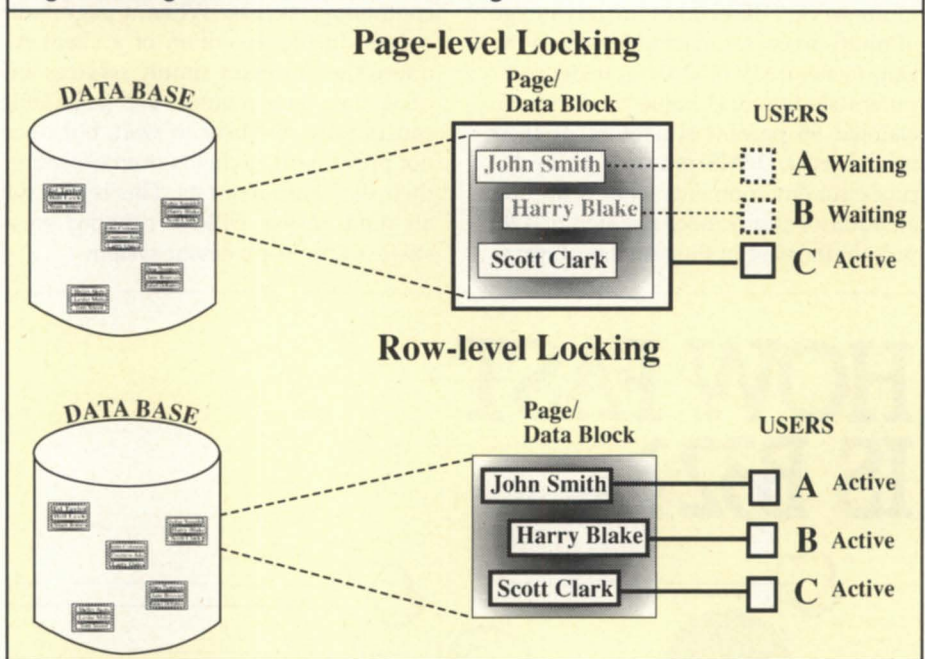

Multiple users entering transactions through the order-entry application are therefore inserting records in the same ORDER table. Page-level locking requires each user inserting into the table to acquire a lock on the next available data block. If more than one user attempts to insert a record, all users must wait while a single user updates the data block. Moreover, most tables contain indexes, and similar locks would be required on the index blocks before the transaction is complete. This concurrency issue is a serious problem since each index block typically affects a large number of records in the table.

Record-level locking minimizes resource contention by allowing a higher level of granularity. Instead of page locks, a row-

level lock is required for every row being updated. However, these vendors disagree about the methods used to perform such tests, despite several efforts to develop standard benchmarks. While standard benchmarks are implemented using simulated applications in a dedicated environment, the true test of DBMS performance involves real-world applications in a real-world environment. When real-world testing is not feasible, you can best grasp the true performance potential of a DBMS by understanding its underlying architecture. Δ

Jojo Anonuevo is the AOS/VS product line manager for Oracle Corporation. He may be reached at 20 Davis Drive, Belmont, CA 94002; 415/598-8000.

# Tools you can depend on

**I**n some professions your life depends on the tools you choose—so you choose the best.

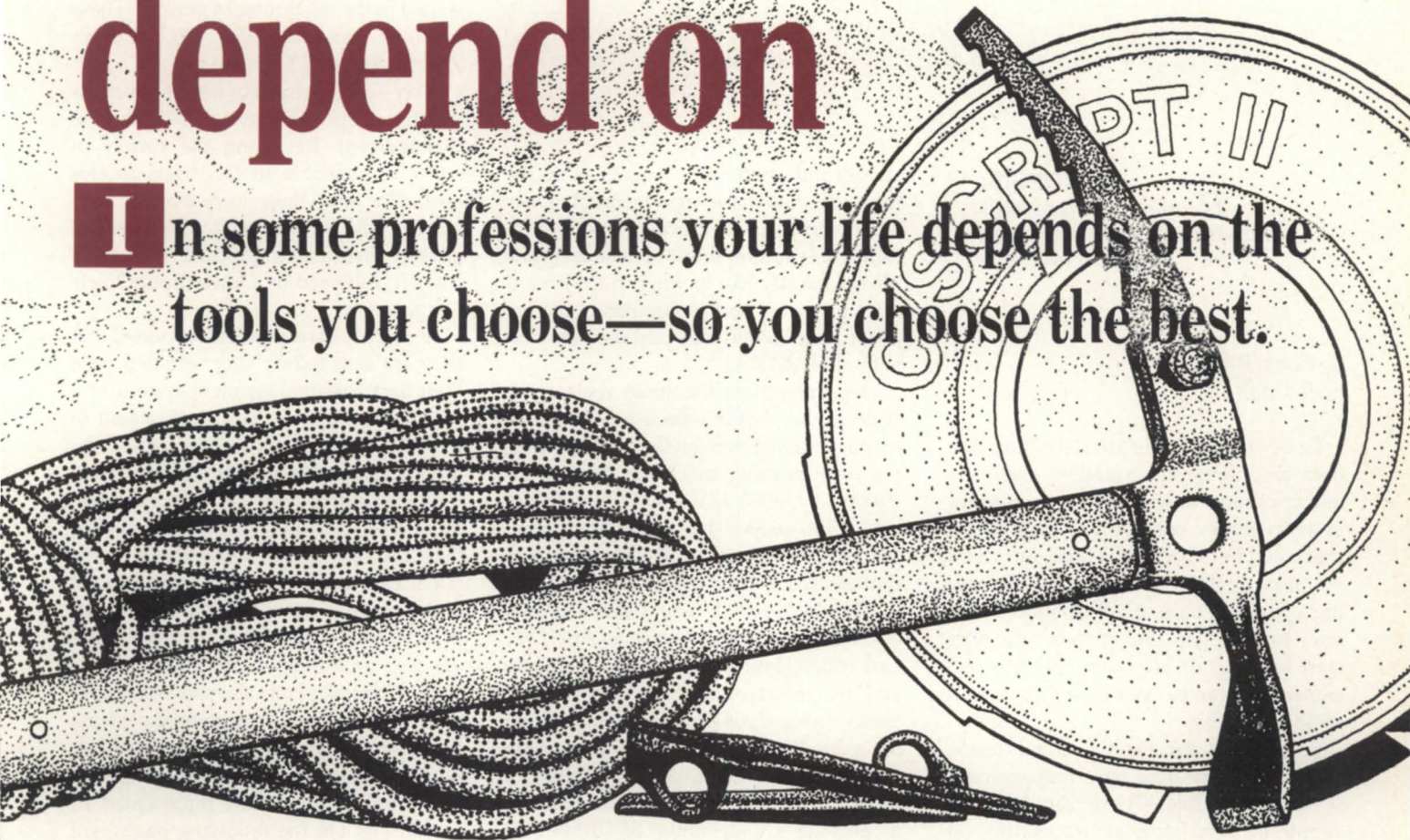

- **C/SCRIPT** - COBOL application development system.

- **Screen Demon** - Pop-up windows for DG terminals. Hot-key calculator, CLI, print screen, and more. Works with existing COBOL programs.

- **ICHOST** - Single and multi-terminal ICOBOL interpreters for MS-DOS systems. Up to 33 users. Fastest product of its kind.

- **Scream** - Fast file Transfers over ASYNC lines.

- **DG Dump/DG Load** - Create and load DG-compatible dump files on your MS-DOS or Unix system.

- **ICOBOL to RM/COBOL Translator** - Translates ICOBOL source code to RM/COBOL.

- **ICIO** - Access ICOBOL data files from a 32-bit program.

For more information

(205) 821-0075

## Threshold, Inc.

165 East Magnolia • P.O. Box 831 • Auburn, AL 36831

Circle 64 on reader service card.

C/SCRIPT is a registered trademark of Threshold, Inc.



# They went data way

**SYNOPSIS:**

*Reader survey reveals that data base management comes in all forms*

by Robin Perry  
Focus staff

Under the rather broad definition of a data base, there are countless examples and applications. Almost every computer system contains some sort of information that could be called a data base. But when you take on the responsibility of managing a complex base of information that is vital to an organization, then you may start looking for a system specially designed to organize your data and make it easily accessible.

Fortunately for Data General users, there are many data base management systems available. These can be very simple or very complex, depending on the user's needs.

In the June issue of *Focus*, we inserted a

survey into members' magazines on the topic of data base management. Once again, our readers responded with interesting revelations about their sites. While it's not exactly like looking in a mirror, it does give us a sort of composite picture of the people who make up the membership of NADGUG.

Here are some of the things we learned: Among the people who use a data base management system on their DG systems, the most popular machines are the MV/4000, MV/8000, MV/10000, MV/15000, and MV/20000—no surprises there. Almost every model of DG machine was represented at least once, from the Nova to the MV/40000. The overwhelming operating system of choice is AOS/VS. Our conclusion: if you have a Data General machine running under AOS/VS, there is a data base management system for you. It's too early for information about the new Unix-based machines to show up in our survey, but DG has vowed to provide a wide range of DBMS systems for them too.

Eighty-six percent of the respondents

did not use other vendors' CPUs in conjunction with their DG systems. But reflecting DG's strategy for interconnectivity with a wide variety of vendors, there were several different vendors represented in the remaining 14 percent. These included Tandem, IBM, DEC, Unisys/Burroughs, and Compaq.

Sixty-seven percent of the respondents purchased special software for data base management. Revealing the variety of software available to DG users in this particular area, there were over 20 software products mentioned. The most frequently mentioned product was DG's Infos II, followed by Oracle from Oracle Corporation.

A majority of respondents reported that they are satisfied or very satisfied with their data base management system.

A few areas emerged as prominent in the section that asked readers to describe their primary data base application. Many people said that their data base management system is used to manage mailing lists: the lists included members of the American Yacht Racing Union, lists of target markets for an association, lists of prospective customers for a software vendor, promotional lists, and so on. Manufacturing plants also showed a fondness for data base management systems for use in inventory control, accounting, quality control, and tracking. Also, several municipalities were represented in our survey. On the following pages, we present brief profiles of two of these data base applications. Δ

## Sonoma County traffic report

Sonoma County, north of San Francisco, is renowned for its glistening hills and redwoods, and for the wine that is produced from the grapes that grow there. But some people remember the topography for another reason. The county is the site of 2-3,000 traffic accidents every year, with that amount increasing annually.

An important function of the Sonoma County Public Works Department is to keep a detailed inventory of these accidents. Some 70 terminals are kept busy entering information

into the MV-based system. "We're constantly using the 4GL DBMS all day long. We have a constant trickle of reports from the CHP (California Highway Patrol)," said Keith Godsey, senior engineering programmer.

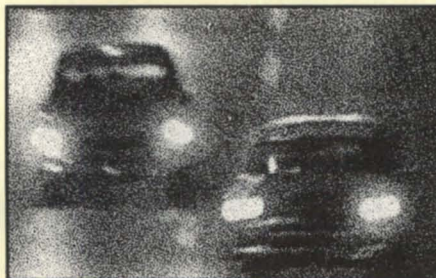

Every time an accident occurs in Sonoma County, information from the Cali-

fornia Highway Patrol is put into the data base. This information includes the location of the accident, the number of vehicles involved, vehicle code violations, road conditions, time of day, injuries, and other factors. Using this base of information, the computer system looks for unusual patterns in accidents, explained Godsey.

"A couple of years ago, we discovered a problem with stop signs. That is, if we didn't have a 'stop ahead' sign warning somebody that there was a stop, in about 40 percent of the cases, a person ran the stop sign and got involved in an accident. Because of the analysis that was done by our package, we put 'stop ahead' warn-

# HOW FAST CAN B32 ADAPT TO CHANGE?

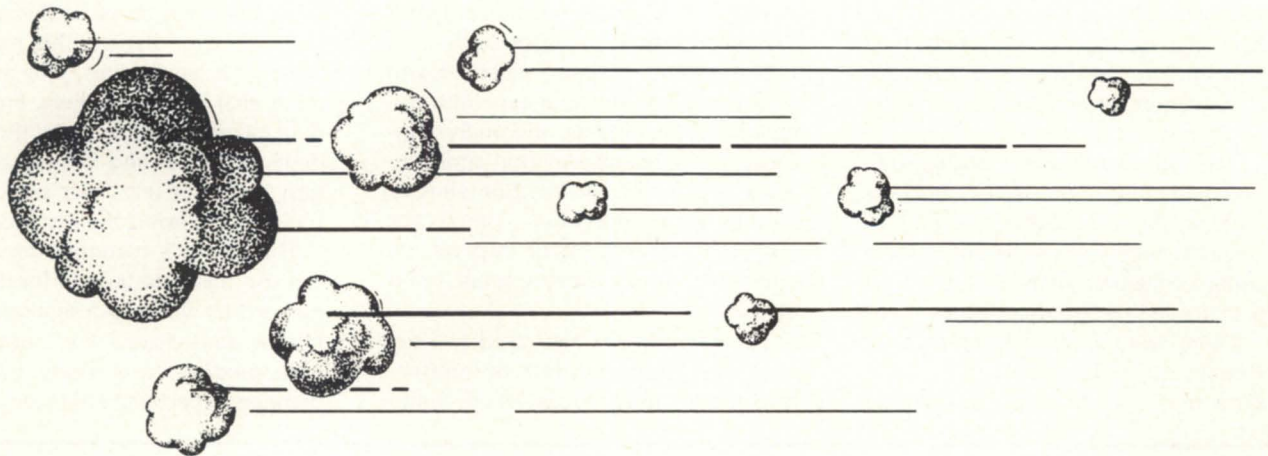

## WANT TO SEE IT AGAIN?

B32 is now available for Dasher 386 and other 386 PC compatibles...and it's still the fastest software around!

B32 under UNIX is a full implementation of B32, with all the features of B32 of Data General MV systems. Complete compatibility with Data General Business BASIC is maintained.

And of course, B32 brings you more of everything: program size, statements, and variables.

Best of all, B32 is easy to install, works just like your B32 or Business BASIC does now, and is backed by the best support in the business.

Call now for your free, full function B32 Demonstration Tape.

**MAXON**  
COMPUTER SYSTEMS INCORPORATED

**(212) 227-1922**

575 Madison Avenue  
Suite 1006  
New York, New York  
10022

85 Scarsdale Road  
Toronto, Ont., Canada  
M3B 2R2  
Fax: (416) 445-6228

U.K. Agent:  
SYNERGISTIC SOFTWARE COMPANY LTD.  
Hughenden House, Main Street  
Collingham, U.K. LS22-5AY  
Tel: 09 37 73446 Fax: 09 37 66903

ing signs throughout the county road system, and it reduced that type of accident by a considerable amount."

**Switching to Info**

The accident data base is just one of several maintained by Sonoma County. Godsey is in the process of converting the data base from a Fortran 77 program to Info, a DBMS from Henco Software, because "Info is a heck of a lot easier to work with than Fortran. Not only that, with Info, our users can generate their own queries and reports."

Another reason for choosing Info was availability. Sonoma County was looking for a job costing system. Fortunately, nearby Alameda County was using a system that was similar to what was needed by Sonoma County.

There were a few differences, of course. Alameda County was using the software purely as an accounting

tool, while Sonoma County was looking for a management tool. Also, Alameda County was running on a Prime computer system, while Sonoma County has a Data General system. But by using Henco's Info and a customized package from Quartet Systems, the system was converted for use by Sonoma County. "Quartet Systems was able to take a great deal of the source code virtually intact and move it over to our system and run it," Godsey said.

The system, still being installed, will be used to keep track of expenditures, make cost projections, and analyze information. This information could include studies of construction sites or billings from individual contractors. "Basically, management reports on where the money is being spent," said Godsey.

The data base is also used to keep track of a large inventory of information about county roads—their condi-

tion, traffic counts, radar speed studies, inventory of road buttons (where they are and where they have helped reduce accidents).

This information will be used with a program in development that will display a graphic history of an intersection. "What I'm doing with Info is to integrate all these systems into one, where if a person wants to see everything that's happened at this intersection, he can display the road, see whether it has buttons, plus any accidents that happened there. From that data he can determine why these accidents occurred, and if there is a pattern," said Godsey. "Then you can take the steps to correct the situation."

The county's planning department can use this data base to locate information that will help design safer roads in new subdivisions. For example, if a new subdivision is being built and planners expect that 600 more cars will

**Electronic Mail for PCs**

**CEO™ Compatible**

WITH

**TLC EXPRESS™**



Remote site with personal computer

EMAIL

1-800 Dialup or Telenet

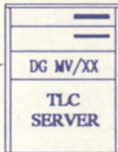

- Save on Phone Charges
- Tie in Remote Salespeople, Branch Offices, and customers
- Transfer DOS and AOS/VS files
- Integrate TLC EXPRESS into your own software

Call us for more information and a demonstration diskette.

**TLC Systems, Inc.** 508-478-8211  
5 Airport Drive, Hopedale, MA 01747, FAX: 508-473-3109

DG, CEO, AOS/VS AND MV ARE TRADEMARKS OF DATA GENERAL CORP.

Circle 66 on reader service card.

Dallas, we've got you covered!

Affiliates in Chicago



We are Compuplan International, Inc., an independent computer service company servicing Data General and compatible peripherals!  
Now get the service you deserve from the people you can *trust!*

**Desktop Systems to the MV Family, plus everything in between!**

Fax your configuration for a free quote—(214) 224-3281  
We also buy, sell, and rent Data General & PC clones.

Affiliates in Tulsa

**800-228-8889**

Houston, we've got you covered!

Circle 7 on reader service card.

be on the road each day because of the subdivision, the system will be able to predict how many traffic accidents will occur, said Godsey. The planning department could use the data base to find ways to reduce the number of potential accidents. "Maybe two years ago we had a subdivision on this type of road, and we had a whole bunch of this type of accidents because we didn't have a certain kind of warning sign there. If we see that type of situation come up again, we need to know to take this type of action," Godsey said.

As Godsey integrates more of the data bases, he will continue to explore useful ways to use the information. "It's an on-going system, still being developed. As we learn more and more, we'll be doing a lot more conversions." △

## Healthy customer list invigorating for Life Fitness



The mainstay of the Life Fitness Company of Irvine, California, is the Life Cycle, a programmable stationary bicycle. Keeping Life Fitness' data base in robust condition is a Data General MV/15000 Model 20 running Oracle, a relational data base management system.

The four-year-old company bought its first DG machine (an MV/4000 running Basic) in 1986 to use mostly for accounting purposes. But as the customer list grew, it became apparent that a superior data base management system was needed, said Senior Systems Analyst Ron Chagnon.

A major marketing tool for Life Fitness is a customer list of approximately 80,000 names. Each name is assigned different codes. Marketing people can retrieve names off this list according to any of the codes. "When we were running Basic, if we wanted the user to query zip codes, it meant a lot of work

**"YOU NEED DATA GENERAL EQUIPMENT. YOU NEED IT NOW. YOU NEED IT PRICED RIGHT. AND IT HAS TO MEET YOUR SPECIFICATIONS."**



Whether you want to upgrade or expand your Data General system, Security Computer Sales is "The Solution". We are recognized as one of the largest volume dealers in new and used Data General systems and components. That's why we can custom-configure the exact system you need, to YOUR specifications. And whether you need a complete system or just a cable, we make every effort to assure your equipment is delivered when you need it.

Just tell us what you need. Complete systems, CPU's, Controllers, Printers, Drives, Terminals, Memory, and Communications. MV's, S/280's, Nova's and Desktops. We have them all. And when you order from us, your system comes complete — down to the last nut, bolt and cable! What is more, before you get it, we completely clean, fully test — and if necessary, totally recondition — every item we sell.



Security Computer Sales is known for its great deals. You just can't get better price/performance. Our prices are all negotiable and open to bids too. And, we give you an additional discount on all cash purchases. We're buying too, and we pay top dollar. When it comes to the best prices, we are "The Solution".

We guarantee every piece of equipment we deliver to be complete, fully operational, and eligible for servicing by the maintenance company of your choice. And, we offer depot repair, on-site field service maintenance, and guaranteed uptime maintenance on remote sites — all for far less than standard DG prices!

**We Are "The Solution" For All Of Your Data General Equipment Needs**

We offer the best deals and the best price/performance in new and used Data General systems and equipment. Why wait any longer? Call "The Solution" today. Discover the Security Computer Sales difference for yourself!



**"THE SOLUTION"**

**Security Computer Sales, Inc., 622 Rossmor Building  
500 North Robert Street, St. Paul, MN 55101**

**PHONE: (612) 227-5683 or FAX: (612) 223-5524**

Circle 56 on reader service card.

in MIS to write a program that has an index on that particular field. With Oracle, you develop your application according to the specifications that were laid out through management and the programming staff, and all you do is enter "Query" and you basically can query off any field that's on the screen. You don't have to rewrite anything," Chagnon said.

"I know the marketing staff love it, without a doubt. They don't have to come to MIS and say, 'Give me a report that shows all the customers who bought this type of product over this time period.' They just go in there and query it up."

The customer list is updated daily by the accounting department, tele-marketing, and sales staff, thus eliminating a step, and chance for error, in transcribing information from one department to another. "There are two sides to the house, the accounting side

and the sales side. Both are updating and maintaining that particular data base," said Chagnon. When new sales leads come in they are entered into the system by the sales staff, he said.

"As the lead goes through the normal process, more information is captured about that lead. Eventually, when a sale is made, accounting starts to work with it. When (the salesperson) writes the order, they've already got all the information. It then has to be approved and that's when accounting gets into the loop. The normal process of handling customers has been simplified."

Chagnon said that he is very satisfied with Oracle because of the product's flexibility. "Because we are a marketing-based company, we plan to do a lot of market analysis work. (With Oracle) we can put together a design for software and halfway through the project, if we run into a snare of some sort,

we have the freedom and flexibility to change in mid-course without rewriting everything. It really gives you the flexibility to make design changes."

Life Fitness is adding to its product line, (there is now a whole series of programmable exercise products) and venturing into new markets. While previously it marketed mostly to health clubs, it is now reaching out to the private sector. With the expected growth of the company, Chagnon is anticipating growth in the demands on his MV system. The MV "is a great workhorse. It just keeps plugging along, although we're overloading it too much right now," said Chagnon. "We're really going toward networking in a distributed fashion, and that's what Oracle is fantastic for. The users will have access over their PCs. It's going to give them access without going through MIS. You've got to give the users the freedom to be creative." Δ

## FINANCIAL MANAGEMENT SOFTWARE FROM MAXON COMPUTER SYSTEMS

GENERAL LEDGER  
ACCOUNTS PAYABLE  
ACCOUNTS RECEIVABLE  
TAILOR-MADE DISTRIBUTION SOFTWARE

**Responsible purchasers of Financial Management software demand proof of performance – up front.**

**They call MAXON for a demonstration.**

Ask MAXON to show how Maxon software is designed, optimized, and continues to be enhanced for the Data General environment.

Ask MAXON about Maxon's high functionality and unparalleled performance.

Ask about installation.

Ask about training.

Ask about support.

Seeing is believing.

**MAXON**  
COMPUTER SYSTEMS INCORPORATED

AUTHORIZED  Data General SYSTEM DISTRIBUTOR

Call:  
(212) 227-1922

MAXON COMPUTER SYSTEMS INCORPORATED  
575 Madison Avenue, Suite 1006 New York, New York 10022  
85 Scarsdale Road  
Toronto, Ontario, Canada  
M3B 2R2

Circle 45 on reader service card.



**Informed buyers make better buys. Experience MAXON Financial Management Software.**

Winner of Customer Satisfaction Awards for previous three years.

Over 200 companies currently operating Maxon Financial Management Software.

MAXON is an Authorized Data General Systems Distributor.

Data General is a major force in the computer industry and has installed over 226,000 computer systems worldwide since its founding in 1968.



# FREE MAINTENANCE

FREE  
MAINTENANCE

**One year FREE Maintenance on Us,**  
on any of our High Performance Disks or Tape Systems Listed below.

**DDS Max 1066**  
\$23,695.00  
1066 MB  
\$22.22

**Disk Subsystem**  
Price for Subsystem  
Formatted Capacity  
Price per MB

**DGC 6357**  
\$34,700.00  
862 MB  
\$40.26

**DDS ZIP 15**  
\$16,655.00  
1600/6250 BPI

**Tape Subsystem**  
Price for Subsystem  
Density

**DGC 6299**  
\$29,690.00  
1600/6250 BPI

Offer also good on DDS Max-317, 429, 731 MB Disk Subsystem  
**CALL TODAY FOR DETAILS**

*We live our motto*  
"Total Solutions, Single Source".



40 West Gude Drive, Rockville, MD 20850  
301-424-7870



# B uilding blocks for design

**SYNOPSIS**

*Armed with a few basic design principles and the right development system, many people can implement their own solutions for managing office information.*

by Sue Dintelman  
Special to Focus

Who should read an article about data base design? You would assume that a programmer developing a new inventory system would be interested, and probably a data base administrator in charge of corporate information. But what about the sales manager, the office administrator, the word processing manager, or perhaps the department secretary, or personnel director? In today's automated office where word processing and spreadsheet knowledge are commonplace, more and more people need to be involved in designing computerized systems for managing information.

Data base systems, although not as widely understood or embraced by office personnel as spreadsheet and word processing packages, have become more usable by end-users who do not have traditional data processing training. By removing some of the difficulty of using a development system, the real problem with implementing an information system is more openly exposed: identifying what you want in your data base and how it should be organized.

What real world situation should this application model? Real-world situations can be very complex, and one difficult part of starting a data base implementation is deciding which aspects of the complex world to model with the very

simple constructs available. People routinely deal with exceptions, complex decision criteria, and special cases, but designing a computer system to do the same can be difficult. The key to a successful information system is to identify and implement the basic, routine tasks—freeing up time for people to work on the smaller percentage of the job that requires special attention.

As an example, consider that you are planning a system to produce packing slips and shipping forms for a company where 98 percent of the packages have U.S. destinations and the remaining 2 percent go to 15 different countries. It makes sense to focus your computerized solution on automating the U.S. packages and limiting your consideration of international packages to identifying them and printing out the information. The shipping personnel can then spend their valuable time working on the special cases that require different shippers, or special customs and export forms.

**Only three pieces**

There are only three constructs that are used when setting up a data base system. Everything you are considering for your application must be one of these:

- **Entity.** Entities are the things, facts, or occurrences of primary importance to

the application. Examples of entities are customers, cars, pieces of equipment, purchase orders, library card catalogue entries, and sales calls.

- **Property.** A property describes an entity, but has no real value itself, outside of the relationship with the entity. A phone number is an example of a property. A phone number is of little use unless it is attached to a company or person. Other examples of properties are names, prices, serial numbers, and dates.

- **Relationship.** There are two kinds of relationships that are considered in data base design: property/entity and entity/entity. For example, a phone number (property) is related to the company (entity) for which it is the phone number. Examples of relationships between entities are equipment and its owners, lawyers and their cases, and customers and their orders.

These are the only building blocks needed to design a data base application, so if things get confusing, just step back and see if what you are considering is a property, entity, or relationship. Remember that you will be fitting complex real-world situations into this simple model of data.

**Steps in design**

The following is a basic outline of the design process. Note that there is no computer work in the list, because the data base design should be done *before* any actual implementation is started. This doesn't mean that some of these steps won't be repeated after you have your system running, but many problems can be avoided by going through the following list with paper and pencil first.

1. Make a list of all the properties to be included in the data base.
2. Organize the properties into entities.
3. Check the entities by using sample data.
4. Determine what relationships exist between entities.
5. Check the design so far by trying the basic operations.

**Make a list of properties**

The first step is to tabulate all the properties that will be included in your application. If your new system is going to replace an existing manual system, take a look at the forms and reports that are currently being used.

# THE 8MM MIRACLE.



Y

ou'd probably think it was miraculous if somebody offered you a disk backup system like this:

- Stores over 2 gigabytes on a \$10 cartridge.
- "Push the button and go home" simplicity.
- A spectacularly affordable price.

MegaTape has a long history of amazing backup feats. But our new 8mm system, GT-88, will be a real revelation—even to the most jaded computer or workstation user.

Start with uncanny compatibility. That's because the GT-88 is



*completely transparent* to your CPU. That means you won't have to spend from now to eternity struggling with modified hardware or patched software; your standard backup utilities will work unchanged.

In use, you'll find the GT-88 can create spare time out of thin air.

It equals or beats standard 6250 bpi tape drives in speed—and you'll never have to hang around to change reels or cartridges.

Of course, buying any new technology involves

an element of faith.

So it's worth remembering that MegaTape has been in the backup business—and *only* the backup business—for nearly a decade. Thousands of our cartridge systems are handling daily backup at sites all over the world.

Our support organization is in place, ready to respond in your hour of need.

So if you'd like to work a few miracles around your site, call MegaTape today and find out how affordable the GT-88 can be.

And that's not a suggestion—it's a commandment.

MEGATAPE CORPORATION  
1041 Hamilton Road  
Duarte, CA 91010-0317  
(818) 357-9921 • Telex: 510 600 7131  
Telefax: (818) 357-2369

 **egaTape**

**THE GREAT LEAP  
FORWARD IN BACKUP.**

The key is to limit the properties to those that are essential for implementing your application. There is often a temptation to include many properties for no other reason than "why not?"

and this can lead to problems. Like many aspects of data base design, there are trade-offs. During this step, balance the additional complexity, space requirements, and data entry needs with a possible future benefit of maintaining nonessential properties.

### Organize properties into entities

Most properties will naturally fall into groups that correspond to your entities. After most of the properties are organized into entities, identify the key field or fields for each entity. The key is used to identify one occurrence of an entity and make it different from every other occur-

*If your new system is going to replace an existing manual system, take a look at the forms and reports that are currently being used*

rence. For example, in an application to keep track of equipment, the property number assigned by your company would be a good choice for an identifier. Inventory numbers, catalog numbers, and other codes can be used.

People are hardest to identify in this way, because their names are not unique. For this reason, a numbering scheme is often used to identify people. Many problems can be introduced into a design if you do not identify the key field or fields correctly. The importance of identifying a key cannot be overemphasized.

Keep in mind that some entities will correspond to events rather than things.

For example, if you are organizing information for expense accounts, you will have information about employees (name, department, job title, etc.) and information about the trips

(date, destination, transportation expenses, food expenses, etc.). In this example, the trip entity models an event rather than a thing. If there are some properties that do not seem to fit with any of your entities, continue with the next steps and come back to them. There may be another entity that you have not identified, but which will be discovered during the design process.

Check the design so far with sample data. On a piece of paper, write down examples of property values for the entities. By working through this step, you can often identify potential problems in your design. Two things to check for at

## Data General • Buy • Sell • Trade

### Processors

MV20000 Model 1 16MB	.....	SAVE \$
MV20000 Model 2 16MB	.....	SAVE \$
MV20000 Model 1 16MB, FPU	.....	SAVE \$
MV20000 Model 2 16MB, FPU	.....	SAVE \$
MV20000 Model 1 to Model 2 upgrade	.....	SAVE \$
MV15000 Model 20 8MB	.....	SAVE \$
MV15000 Model 8 to Model 20 upgrade	.....	SAVE \$
MV15000 Model 10 to Model 20 upgrade	.....	SAVE \$
MV10000 4MB Meter high cabinet	.....	\$26,000
MV8000-II 6MB Meter high cabinet	.....	7,800
MV8000 Model 9300	.....	1,750
MV7800 4MB 16 slot chassis	.....	8,800
MV4000 2MB	.....	2,800
MV4000DC 2MB, 120MB, floppy	.....	4,500
MV4000SC 2MB (w/MCPI) & as DC above	.....	7,000
MV2000 4MB 160 MB disk	.....	9,800
MPT100 Dual floppy	.....	350
MP100 8520-D	.....	350
S-140 256KB Floating point	.....	2,800
Desktop 10 Floppy, 15MB disk	.....	875
Desktop 20 Floppy, 15MB disk	.....	1,295
Desktop 30 Floppy, 15MB disk	.....	1,495
S-120 256K 16 slot	.....	550
S-280 BMC 2MB	.....	7,500

### Processor Options

8997 Expansion chassis MV15, 20	.....	\$7,000
8819 Second IOC for MV10000	.....	5,500
8762 Expansion chassis MV10,8,4,S280	.....	4,500
8761 Floating point unit MV4000	.....	1,500
8749 Battery backup for MV10000	.....	3,200
8746-B Battery backup for 8762	.....	
EXP Chassis	.....	1,800

8704 Floating point unit MV8000	.....	500
4543-B MCP1 8 Async 2 Sync DCH Ptr	.....	2,900
4463-ZT USAM-4	.....	475
4380 ISC-2 (Synch)	.....	950
4372-B TCB-16	.....	500
4371-C TCB-8 for expansion	.....	455
4370-A IAC-16 RS422, 20MA	.....	2,600
4368 IAC-16 RS232, 20MA	.....	3,800
4367 IAC-8 RS232, 20MA Modem Cnt	.....	2,100
1625 Power Conditioner 5KVA	.....	950

### Disk Storage Units:

6061 192MB Disk subsystem	.....	\$ 1,500
6122 277MB Disk subsystem	.....	2,400
6161 147MB Disk subsystem	.....	1,900
6214 602MB Disk subsystem	.....	3,800
6236 354MB Disk subsystem	.....	6,700
6239 592MB Disk subsystem	.....	11,900
6329 120MB MV2000/MV1400	.....	2,100
6336 71 MB MV2000/MV1400	.....	1,500
6363 160MB MV2000/MV1400	.....	2,500

### Terminals:

6053 D2 Monitor with keyboard	.....	\$ 100
6108 D200 Monitor with keyboard	.....	125
6130 D400 Monitor with keyboard	.....	250
6166-X D410 Monitor with keyboard	.....	400
6169-X D211 Monitor with keyboard	.....	275
6391-X D214 Monitor with keyboard	.....	350
6392-X D215 Monitor with keyboard	.....	385
6393-X D411 Monitor with keyboard	.....	600
6394-X D461 Monitor with keyboard (new)	.....	700
Note: Add \$45.00 per unit for Amber Screen.		
6284 D220 Color Monitor w/keyboard	.....	700

### Tapes:

6021 800 BPI new style	.....	\$ 600
6026 800/1600 BPI Blue, non FCC	.....	1,900
6026 800/1600 BPI Brown, FCC compliant	.....	3,000
6125 1600 BPI Streamer, FCC compliant	.....	500
6299 1600/6250 BPI Rack mount	.....	17,500
6300 1600/6250 BPI Meter cabinet	.....	18,500
6311 15MB cartridge MV4 DC/7800DC	.....	900

### Memories:

MV20000, All sizes	
MV15000, All sizes	
MV10000, 2Mb	
MV10000, 4Mb	
MV10000, 8Mb	
MV8000, 2Mb	
MV8000, 256Kb	
MV4000, 2Mb	
MV4000, 4Mb	
MV4000, 8Mb	

**Specials**  
D 216 (New) Terminal .. \$385  
D 211 Terminal .. \$275

## International Computing Systems

P.O. Box 343 • Hopkins, MN 55343

**(612) 935-8112**

FAX 612/935-2580



this time are duplication of properties and duplication of values. For example, you would not want to include an employee address in both the employee entity and the performance review entity. Verify that each property appears only once in the data base.

Figure 1 shows duplication of values. The equipment entity is part of a data base that will be used to keep track of the company equipment. It contains information including a description of the equipment, when and where it was purchased, how much it cost, when it is scheduled for maintenance, and who will do the service.

Notice that the addresses and phone numbers for General Instrument and for Jones Brothers appear more than once. There are two reasons to avoid this re-

**Figure 1: Duplicate addresses and phone numbers**

Inventory#	Equipment type	Service representative	Address	Phone
1367A	COPIER	ALPHA SERVICE	84 S. MAIN	314-7128
478D4	MODEM	COMPUTERLAND	2784 ELM	317-9421
36782T	TERMINAL	GENERAL INST.	146 RT. 85	314-2111
36783T	TERMINAL	GENERAL INST.	146 RT. 85	314-2111
39456	COPIER	JONES BROS.	3784 ANDERSON DR.	317-6501
36789T	TERMINAL	GENERAL INST.	146 RT. 85	314-2111
39457	COPIER	JONES BROS.	3784 ANDERSON DR.	317-6501

dundancy. One is that it takes up space. The more important reason is to reduce the opportunities for inconsistency. For example, suppose we need to schedule the first terminal for maintenance and find out when we call that General Instrument has moved. If we change the address for that record, we now have a company in our data base with two different addresses. When you have duplication of values, it usually means that you really have another entity.

In Figure 2 we introduced a new entity, service reps, for the information about each company that does service

for the equipment. Now when changes are made, there will be no inconsistencies, and the current information will be available for each piece of equipment by using the name of the representative to look up the address

in the service reps table.

**Determine relationships**

There are only three types of relationships between entities: one-to-many, one-to-one, and many-to-many. In the equipment example, the relationship between pieces of equipment and service representatives is one-to-many. Each service representative can service many pieces of equipment, but each piece of equipment has only one service representative. Other examples of one-to-many relationships are clients (one) and their support calls (many); patients (one) and

**MV**

**CONNECT WITH D:drive™**

*The software bridge for LANd locked systems*

**Connect your PC to your MV with D:drive™**

- MV looks like a DOS drive
- No new commands to learn
- Use existing Async ports—no additional hardware required
- Transparent to all application programs and DOS commands
- Random access to databases—no need to transfer an entire file

DOS Only Users won't know they are on the MV, but will appreciate file and peripheral sharing.

Dual System Users will love the ease of switching between terminal AOS/VS and DOS mode, all on the same asynchronous line.

Supports up to:

- 19.2 k Baud
- 30 subdirectories
- 1000 files
- 32 megabytes

Price: Only \$795, plus \$125 per personal computer—up to 32 users.

**Test drive D:drive\***

*\*Order Demo Version today—Only \$49. (Refundable with purchase.)*

**PC**

**DIGITAL DYNAMICS INC.** 3055 Plymouth Road Ann Arbor, Michigan 48105 (313)995-2400 FAX (313)995-3232

Circle 30 on reader service card.

their appointments (many); employees (one) and their insurance claims (many).

One-to-one relationships usually indicate that you can combine the two entities into one. However, there are times when separating a group of properties into a related entity may be helpful. An example of this is a medical application where a large questionnaire is used for about 15 percent of the patients. The several dozen responses to the questions could be added to the entity for patients, but this would make the patient entity more complex than it needs to be. In addition, depending on the type of system you use, putting properties in an entity actually reserves space for the values. If only some of the values are filled in, you will be reserving space that will always be empty. This is avoided by making a separate entity for the questionnaire responses.

Many-to-many relationships occur often in the real world. The classic example

**Figure 2: Redundancy eliminated**

EQUIPMENT		
Inventory #	Equipment type	Service representative
1376A	COPIER	ALPHA SERVICE
478D4	MODEM	COMPUTERLAND
36782T	TERMINAL	GENERAL INST.
36783T	TERMINAL	GENERAL INST.
39456	COPIER	JONES BROS.
36789T	TERMINAL	GENERAL INST.
39457	COPIER	JONES BROS.

SERVICE REPS		
Service	Address	Phone
ALPHA SERVICE	84 S. MAIN	314-7128
COMPUTERLAND	2784 ELM	317-9421
GENERAL INST.	146 RT. 85	314-2111
JONES BROS.	3784 ANDERSON DR.	317-6501

is students and classes. One student can take many classes, and one class can have several students. Other examples of many-to-many relationships are employees and trips (one employee can go on many trips; one trip can be taken by many

employees); and lawyers and cases (one lawyer can be assigned to many cases, one case can be handled by many lawyers).

When using the relational model of data, which is what most systems use today, many-to-many relationships can not be modelled directly. A new entity must be introduced to represent the relationship. If you had properties that did not seem to fit well into one entity or another, it may be because they belong to the new entity that you will introduce to represent the relationship in a many-to-many case.

The diagrams in Figure 3 correspond to the examples above. In this type of diagram, the boxes represent entities and the arrows between the boxes represent the relationships. A double-headed arrow indicates the "many" side of a one-to-many relationship.

Each travel occurrence associates one employee with one trip. The travel entity

## SPECTRA IS BACK!

The innovation and integrity are back. Now as a division of Western Automation, Spectra is back to provide you with high quality, top performing products for your Data General.

### - High Performance Disk and Tape Controllers -

- Spectra 117-Plus**
- Designed for Data General's ECLIPSE and MV series.
  - Supports up to four SMD disks.
  - 2.5MB/sec. transfer rate.
  - Disk interface to the BMC.

- Spectra 310-Plus**
- Fits into Data General's Nova/Eclipse, Point 4, Bytronix, Information Now, Integrated Digital Products and Rolm/1666 series.
  - Supports up to four SMD disks.
  - Up to 3.0MB/sec. transfer rate.

- Spectra 320-Plus**
- Compatible with Data General's Nova/Eclipse, Point 4, Bytronix, Information Now, Integrated Digital Products and Rolm/1666 series.
  - Supports four SMD disks and up to eight 1/2" tape drives.
  - Transfer rates: Up to 3.0MB/sec. on disk, up to 1.0MB/sec. on tape.

- Spectra 27-Plus**
- Fully compatible with DG's ECLIPSE and MV series.
  - Supports four SMD disks and eight 1/2" tape drives.
  - Transfer rates: 2.5MB/sec. on disk, 1.0MB/sec. on tape.
  - Disk interface to the BMC or Data Channel.

- Spectra 30**
- A quality tape coupler for the Data Channel emulating the 6021 tape subsystem.

For more information on any of our DG products, call or write today.

**SPECTRA LOGIC**  
A Division of Western Automation

1227 Innsbruck Drive  
Sunnyvale, CA 94089  
(408) 734-8121 FAX: (408) 734-8188

Circle 58 on reader service card.

is a good place to put expense information for a trip, since it will be different for each employee and each trip.

The enrollment entity associates one student with one class. One property in this entity may be the grade a student receives for the class.

The represent entity associates one lawyer with one case. This entity may have no properties other than the key for the lawyer and the key for the case. Even if there are no additional properties to be modelled, you must still introduce the new entity to represent the relationship between lawyers and cases.

Now you are ready to begin the implementation. Only now, after you have worked through the entire application on paper, should you begin to actually implement your application. You have your good design, which includes the entities, properties, and relationships that you will need to establish. As part of the previous step, you have sketches of the screens for data entry and inquiries. You also have

examples of output formats. Now you can concentrate on the details of using the development package, and you should very quickly see results!

Whether you are implementing a small, single-file mailing list application for yourself, or working on a large, complex system for an entire department, the benefit of following this systematic design process will be evident. △

**Figure 3: Relationships between entities**

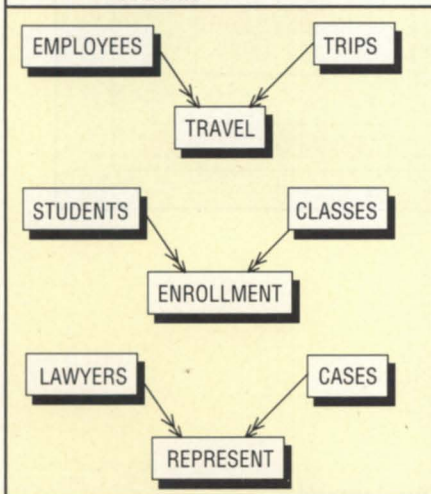

**Check design with basic operations**

Using your property lists and the entity/relationship diagrams, be sure you have included all the properties that you need to produce the different types of output required. For example, in the equipment application, if you need to produce a list of the equipment in each department, you will need to include the department as a property in the equipment entity. In addition to checking the output required, think through how you will add new information and how you will change existing information. Although it may seem like a lot of trouble to actually write down sample values and produce sample reports, it can save valuable time later.

*Sue Dintelman is CEO of DMS Systems and one of the developers of GENISYS, an office information system designed for end-users.*

# RELAX.

## Rave's price catalog has the best deals on DG & compatible equipment.



Give your budget a vacation. Check out the deals on our large inventory of DG and compatible systems, peripherals, parts and equipment. We offer mega-savings. Cash rebates. Immediate delivery. And all include our unbeatable **45-day warranty**.

We buy, sell, trade and lease on everything from Nova to MV.

So sit back, relax and call for your free price catalog today. Then enjoy the savings.



**RAVE COMPUTER ASSOCIATION, INC.**

35455 Stanley Drive  
Sterling Heights, MI 48077  
FAX: 313/939-7431



**(313) 939-8230**



**AUTHORIZED DEALER**

Circle 51 on reader service card.

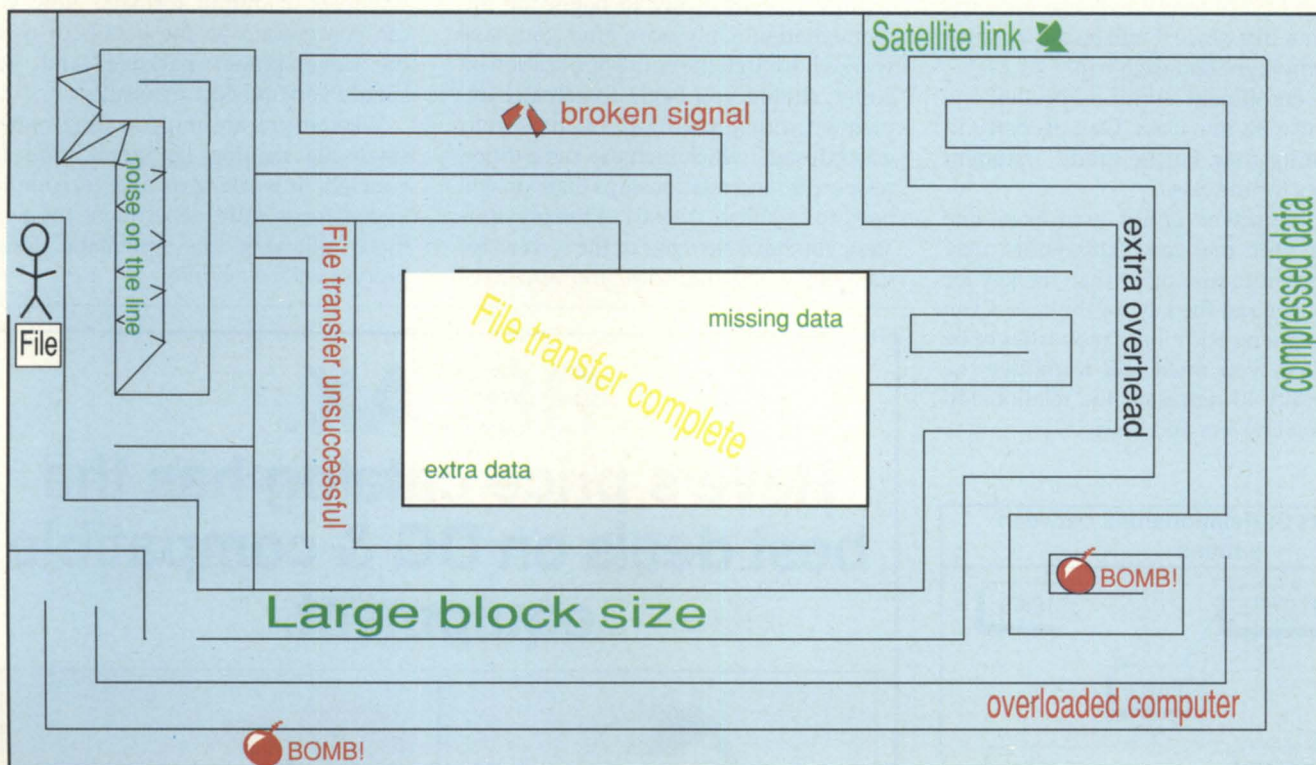

# Trade wars

## SYNOPSIS

*Many factors can affect the accuracy and speed of data transfer. This article analyzes several trade-offs between performance and cost.*

by Rainer McCown  
Special to Focus

In the quest to achieve the fastest, most accurate protocol for your communications needs, there are many trade-offs. These trade-offs can affect block size, reliability, and header information. Some factors that reduce transfer time are full duplex (sliding windows), automatic resume after disconnect, and data compression. Other ingredients in the equation are processor overhead, 7 bit capabilities, and ASCII only transfer modes. In this, my third article on communicating in noise, I will discuss these factors and their effects on data transfer.

### Block size

The protocol packet, or block, is broken into three parts: the header, the data, and the trailer. The information for the header and trailer can be included in 4 to 6 bytes. The size of the data portion is much more variable, going anywhere from 16 to 1,024 bytes. With Xmodem, the overhead is 4 (checksum) or 5 (CRC) bytes and the data size is 128 bytes, setting the blocking overhead at 4 percent.

With a half-duplex protocol, the correct receipt of each block must be acknowledged before the next block can be sent. If the computers are directly connected and have a high availability, then this turn-around overhead can be short. Decreasing the block size to 64 characters increases overhead from 6 to 12 percent, which is only marginally significant. Conversely, increasing the block size to 1,024 bytes with less than one percent overhead will save less than 6 percent in transfer time.

### Turn-around

Many situations will delay return acknowledgement. A satellite link introduces a half-second delay. A packet-switching data network or a fully loaded computer can introduce several seconds of delay, causing significant increases in the transfer time, especially in a transfer using small block sizes. These effects have induced many people to go to larger block sizes. I personally feel that the best solution is a sliding window (full duplex) approach.

### Header information

The file transmission process also consists of three parts: connection/identification, data, and end of transmission (EOT) codes. With early Xmodem, a single-byte header was sent every 10 seconds until there was a response. Xmodem CRC added a second byte to the header so the receiver could recognize it as having CRC capability. This growth capabil-



**Rock Solid Second Source**  
**Huge Stock Of DG Equipment**  
**Fully Reconditioned & Warranted**  
**Famous For Fast, Reliable Delivery**  
**Professionally Staffed Service Depot**

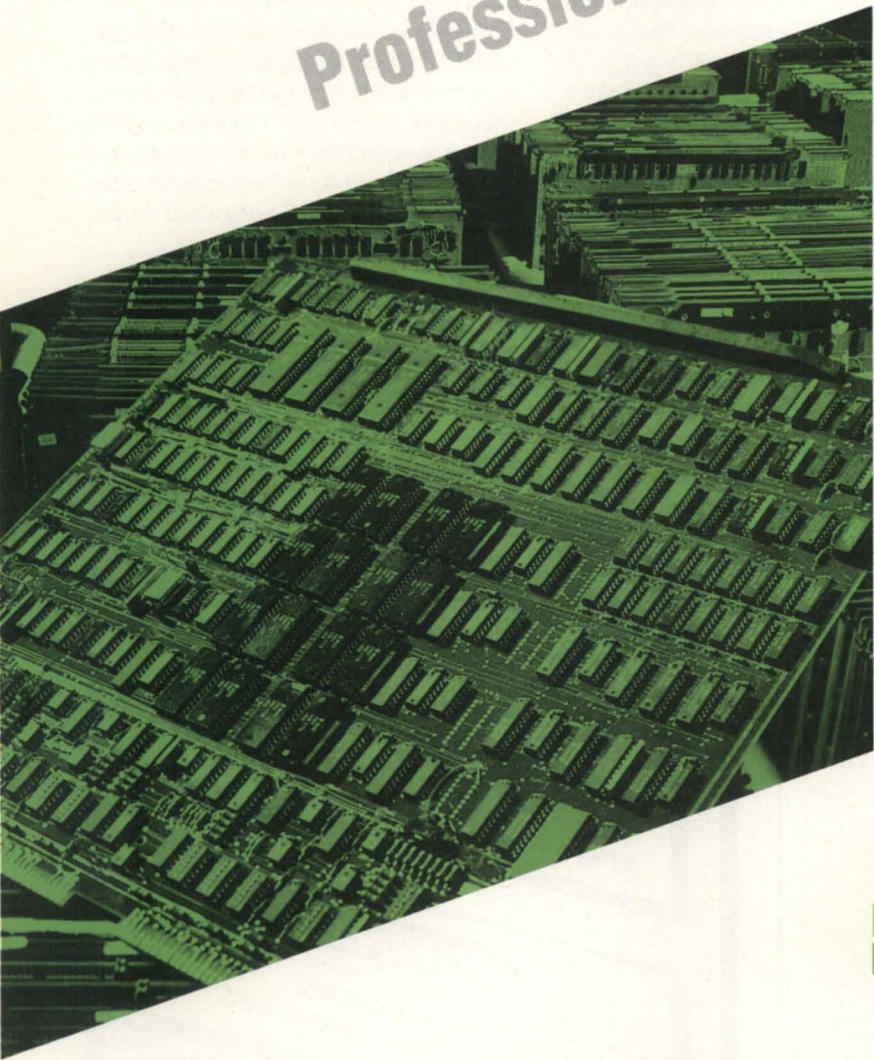

It takes tons of Data General equipment to fill a 12,000 square foot warehouse.

Ours.

Maybe we could get by with a little less, but then you'd have to wait for what you need.

And we didn't get to be one of the world's largest Data General second sources by making our customers wait.

So, if you need something from the Data General line, what are you waiting for? Give us a call right now.



**DATARAM**  
AUTHORIZED DISTRIBUTOR

**(313) 524-4900**

**FAX: (313) 524-4970**

**575 E. Big Beaver, Troy, Michigan 48083-1301**

Circle 46 on reader service card.

ity was possible because the original Xmodem was designed so that extraneous characters in the header would be ignored. This compatibility shows how important it is to define what happens with invalid commands so that when a new version needs to add information, it can do so without alienating itself from the older versions still in use.

More complicated protocols such as Kermit exchange a greater amount of information in their headers. This information includes filename and size, and system information like the revision number and software capabilities. Protocol options are negotiated to maximize throughput before the transfer starts.

It is important to keep enough of the directory information associated with each file so that the file received is completely indistinguishable from the original. This simplifies housekeeping and makes for better organization. Xmodem not only does not keep the original filename and date, but, because Xmodem has no mechanism for sending partial

blocks, the file size is rounded up to the next larger block size.

### Reliability

Reliability is hard to quantify. If a signal is clear and you simply need confirmation that data was sent correctly, then Xmodem can handle it with no problems. But when noise interferes with the signal, Xmodem deteriorates rapidly. The more retries you have, the greater the chance of bad data getting through. Xmodem has the propensity to "hang" or "lock up" and then time out and abort, thus limiting the chance of a bad block getting through on a bad line. This can be annoying, but it is not as bad as ending up with corrupted data. Use of a smaller block size will improve error detection and minimize the amount of data that needs to be retransmitted for each error. A cleaner approach is to use a more robust protocol with improved error management.

Xmodem returns only one byte for each block received: an ACK (acknowledge-

ment) or a NAK (negative acknowledgement). There is no error checking on this byte and no association of this byte with the block of data. Thus, a bunch of noise on the line could create a random string of ACKs and NAKs that would then randomly ACK or NAK the blocks of data being sent without regard to the actual data integrity. The Xmodem lockup problem occurs when the receiver is expecting one block and the sender is sending a different block due to an extraneous ACK or NAK.

Noise that causes extra or missing data is much harder to compensate for than changed data. If the receiver has made a read request for 128 bytes and only 127 show up, the program will wait and grab the first byte of the next block. One solution is to make one-byte read requests, but that action multiplies the operating system overhead by 128 times! Protocols that check for errors in this way severely impact system performance and are not able to receive data at higher baud rates. The solution I find is to use a full duplex

## ORDER ENTRY ORDER STATUS SALES AND MARKETING

WITH

### TLC EXPRESS™



Remote site with  
with personal computer

1-800 Dialup  
or Telenet



- Offload MV applications to the PC
- Tie in Remote Salespeople, Branch Offices, and customers
- Electronic Mail, and File Transfer
- VARS, integrate TLC EXPRESS into your own software

Call us for more information and a demonstration diskette.

**TLC Systems, Inc.** 508-478-8211

5 Airport Drive, Hopedale, MA 01747, FAX: 508-473-3109

DC AND MV ARE TRADEMARKS OF DATA GENERAL CORP.

Circle 67 on reader service card.

## K&M Computers

Sell • Buy • Lease

**(516) 232-2530**

FAX (516) 232-2709

Data General

Specializing in peripheral and communication sales and complete systems any configuration.

**DATARAM**  
AUTHORIZED DEALER  
Lifetime Warranty  
No Maintenance Required

77-10 Allwood Avenue  
Central Islip, NY 11722

Circle 41 on reader service card.

## Memory Boards for MV/15000, MV/20000 Computers

Dataram DR-1520 memory comes in 8, 16 or 32MB board capacities. The add-in memory uses 1Mb RAM technology to upgrade processor performance, and does not affect DG service arrangements. Boards are user installable, have Enable/Disable switch and LED indicators.

**Dataram Corp. Phone 1-800-822-0071 (NJ 609-799-0071).**

Circle 22 on reader service card.

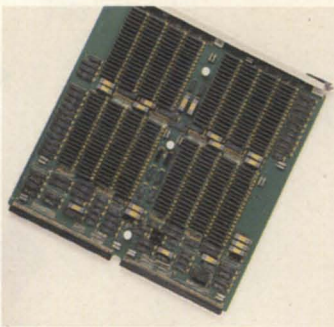

## Now up to 16MB Total Memory for MV/6000, MV/8000, MV/8000 II

Cost-effective DR-6080 memory boards improve response time, add power for more users, applications. Expand to full 16MB capacity with 4MB, 8MB, or 12MB boards, trade up to higher capacity. Full lifetime warranty.

**Dataram Corp. Phone 1-800-822-0071 (NJ 609-799-0071).**

Circle 26 on reader service card.

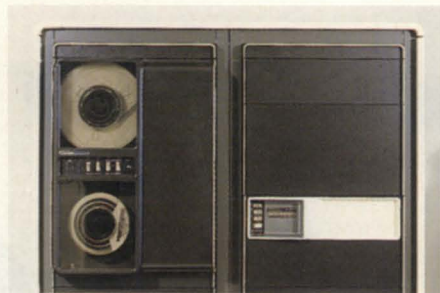
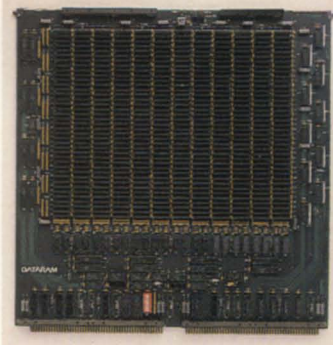

## Main Memory Upgrade for MV/4000 and MV/10000

DR-280 series memory offers a choice of 2, 4 or 8 MB of main memory per board. The DR-280 operates with highest reliability DRAM technology and can be installed in minutes — without hardware or software changes. **Dataram Corp. Phone 1-800-822-0071 (NJ 609-799-0071).**

Circle 23 on reader service card.

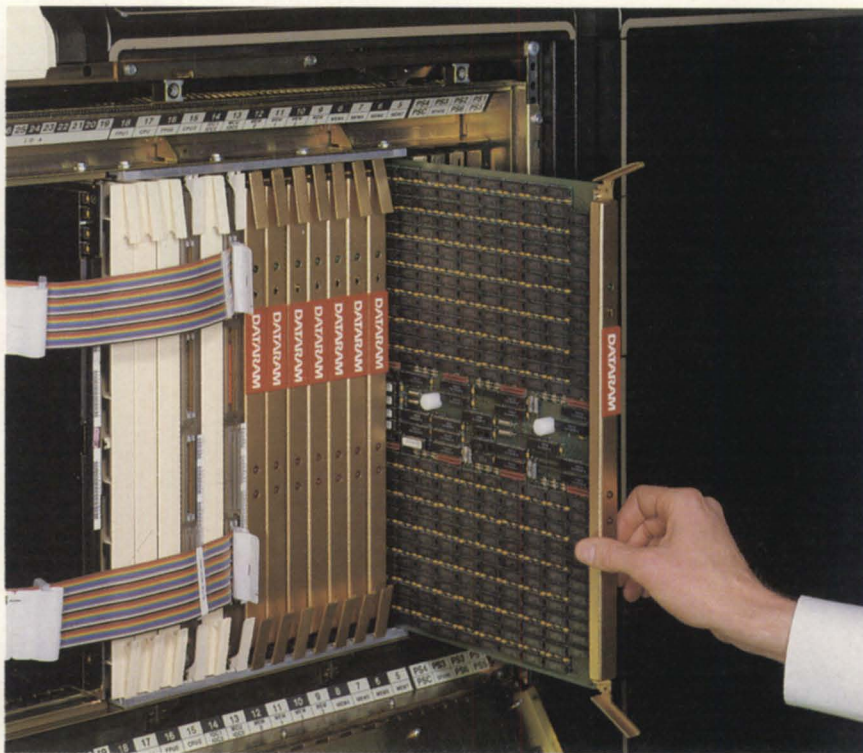

## Lifetime Warranty on Memory for MV/1400, MV/2000, DS/7500

High-reliability 1Mb DRAM technology on 4MB and 8MB boards brings low-cost boost to processor performance. Dataram DR-1420 memories plug directly into all three processors, do not affect DG service arrangements. **Dataram Corp. Phone 1-800-822-0071 (NJ 609-799-0071).**

Circle 24 on reader service card.

## Up to 16MB Extra Main Memory for MV/2500 Series

Dataram's DR-2500 memory boards, available in 8MB and 16MB capacities to improve processor speed and power, are fully compatible with hardware and software for DG's MV/2500. The plug-in memory needs no maintenance, has a lifetime warranty, and is available on a 30-day trial basis. **Dataram Corp. Phone 1-800-822-0071 (NJ 609-799-0071).**

Circle 25 on reader service card.

# Memory is power.

## Plug more speed, users, functions into your DG with reliable Dataram memory

No matter which DG computer you own, Dataram has memory to fill it. Totally DG compatible. Designed and built maintenance-free, to keep costs down. Backed by a lifetime warranty that delivers spares overnight — and pays the shipping!

Dataram add-in memory is the efficient path to maximum performance. With up to 32MB on a single board, it can overcome system restrictions on your MV/1000, your MV/2000, or

any DG in between, for more speed or users, or for expanded applications without sacrificing speed.

Buy just what you need now. When you need more power, trade in your Dataram board for a generous credit on a larger one. Or try a Dataram board for 30 days, no obligation. Find out how much more computer your DG can be — and how little it can cost. Call for details on Dataram memory for Data General.

# DATARAM

P.O. Box 7528, Princeton, NJ 08543-7528 • 1-800-822-0071 (NJ 609-799-0071)

Circle 27 on reader service card.

A · n · n · u · a · l · . . . C · o · n · f · e · r · e · n · c · e

16<sup>th</sup>

New Orleans - New Orleans Hilton & Convention Center  
September 18 - 21, 1989

### *Emerging Technologies: Changing the Challenge*

*The 1989 NADGUG conference revolves around a theme that will effect all of us for years to come. Emerging hardware and software technologies are changing the challenges faced by all of us. Be there — at the cutting edge.*

*During these four days in New Orleans you can find the answers you've been looking for at the largest gathering of Data General users ever! Pick from seminars, roundtables, exhibits; and technical, management, and end user sessions. You'll talk informally with the experts, and meet other DG users with similar systems and needs.*

*Plan to join us in New Orleans! By now you should have received your Conference '89 registration packet. If you register before August 19, you'll be eligible to win a DG/ONE and a free trip to the 1990 UK Users Group Conference in England.*

*There's a \$75 late fee for registrations received after August 19, and the New Orleans Hilton can't guarantee reservations after this date. So...don't be late! If you need more information, contact the NADGUG staff at 1-800-USR-GRUP (512/345-5316 outside U.S.)*

**NORTH AMERICAN  
DATA GENERAL  
USERS GROUP**

**1-800-USR-GRUP  
(512/345-5316 outside U.S.)**

protocol, which can extract valid blocks of data from the input stream, even if the blocks are not aligned with the blocks read by the operating system.

**Reducing transfer time**

I have pointed out that increasing the block size can reduce the transfer time in a noise-free environment, but in an uncontrolled or unknown environment, this modification can be a poor choice. The reducing effect of a larger block size can be had by a sliding window protocol at the cost of only a little extra overhead.

Data compression applied to text files can easily decrease transfer time by 30 percent. Complicated schemes can provide 50 percent, or more, compression; but often the added processor overhead will prevent the additional compression from being realized.

Two other things must be considered when deciding whether to implement a compression algorithm in the protocol: stand-alone compression programs on the PC such as ARC or PKZIP can compress the files much more effectively than an on-the-fly protocol; and certain modems that implement MNP (Microcom Network Protocol) compression will perform compression in hardware between two MNP modems, regardless of the software protocol used.

If either of these situations exist, then protocol data compression could hurt, rather than help, the transfer times. Because of the large advantage in a few cases, such as a data file that is mostly filled with nulls, a very simple compression scheme could be valuable. This simple scheme might notice a large block of the same character and then send a special packet that contains just the count and the data value.

Automatically resuming an aborted transfer can save a lot of time (but not very often). There are several options on restarting an interrupted transfer. If the connection is broken and part of the file has been received correctly, that partial file can be written to the disk along with enough information to uniquely identify the file, the date, and the source. Then the next time that a connection is made and the file is resent, the protocol recognizes the fact that it's a continuation, and sends only the rest of the file.

This general solution requires a very sophisticated protocol and a longer

startup time to interchange the additional information. Also, if the transfer is aborted on purpose, a file fragment will be left on the disk.

A less complicated solution is to "hold" the current state of the transfer in memory and switch to a submodule that can handle the communications (dialing the phone, etc.) and start-up negotiations. This module would ensure that a resume

was appropriate, then revert back to the main transfer program. This solution would not work if the operating system terminates the program when the connection is broken.

**Special situations**

Seven-bit and text-only capability are features of Kermit. These capabilities were designed several years ago to be compat-

**UK and EUROPEAN users**

***We sell and support all DMS products in your own time zone!***

Want to **dramatically** reduce your disk access times and thus booster system performance with **DISKOPT?**

Need comprehensive information on your system's usage to enable you to tune the software and hardware utilization on your machine? Need masterly presented figures to plan and justify your upgrade paths? You need **RAS**, call us!

Ever heard of a 4GL which allows you to create systems as complex as personnel or sales order processing systems without one line of 4GL code? With full data interchange with CEO data tables or general information stored in CEO or WordPerfect? We have! Steal a march on your competitors, move into the 1990's and let us help you help your company with **GENISYS**.

*For more details on all these products, contact us now:*

**Le Software Man Ltd.** Telephone: + 44-1-809 2762  
 PO Box 545, London N7 8DF Telex: 9312110518 LS G  
 (England) Fax: + 44-1-809 2762

**le software man** LTD.

Fluent French and Spanish spoken here, some German . . . and at times we also manage a little English!

We also sell the famously tight *GUARDIAN* access & logon security software, *INFO-LYNX*, the bewitching *SCREEN DEMON*, and of course . . . *THE\_ULTIMATE* and *The\_ULT Routines Library*. With such vintage portfolio on offer we have got to be talking to you some day. So don't leave it to chance, circle your reader response card or call us, the likelihood is: we'll solve your problem!

Circle 21 on reader service card.



# OFFICE AUTOMATION WORKSHOP FOR DATA GENERAL USERS

Sponsored by OASIS (the Office Automation  
Special Interest Subcommittee)

**September 18, 1989**  
**New Orleans, Louisiana**  
**New Orleans Convention Center**

## Join OASIS for the annual conference workshop with sessions including:

- *20/20 Integration*
- *CEO Data Tables*
- *Wordperfect 5.0*
- *Data General Customer Support Center*
- *"Brainstorming" — Security issues in future  
Revs. of CEO. DG Development staff  
will be in attendance.*

This workshop is held in accordance with the 16th Annual North American Data General Users Group conference September 18-21 at the New Orleans Hilton and Convention Center.

Register for the workshop by checking the appropriate box on your conference registration form, due August 19, 1989. On-site registration will be available. Cost of the one day workshop is \$75.

For more information  
contact:

Charlene Kirian	704/251-9551
Bobbie Pressman	312/948-1814
Wes Thomas	614/764-4361

NORTH AMERICAN  
DATA GENERAL  
**USERS GROUP**

ible with all of the mainframes and mini-computers available at the time. Since many of these computers would only accept 7-bit ASCII characters, excluding the 32 control characters, this capability was built into Kermit. It is probably not useful in a protocol today. Not using the control characters does have the advantage that XON/XOFF flow control can be active during the protocol transfer, which is often a problem with other protocols.

### Summary

The same protocol must be available at both ends of a communications channel in order to perform a file transfer. If you only communicate between certain sites, any protocol will work, but if you occasionally need to transfer files to other companies or locations, then it is important to use one of the popular protocols. Xmodem is the most widely available PC protocol, with most minis and mainframes supporting it. Kermit is the most popular protocol for mini and mainframe computers and is available on most PCs. Proprietary protocols such as Blast, or the Crosstalk and Hayes protocol, are usually more expensive, but they come with support and maintenance. The proprietary protocols are potentially more robust and provide more features.

Full duplex capability provides the best combination of trade-offs for the user because it increases error detection and correction capabilities while reducing the total transfer time. File header information should be interchanged so that the transferred files do not lose their integrity. A combination of a file compression program, such as ARC, with the Xmodem protocol provides this capability, in addition to providing another layer of error checking along with, of course, compression. I find that enhanced capabilities such as transfer resume, compression, and the capability to transfer files in both directions simultaneously, are valuable only if they come at very little additional cost in terms of processor overhead, dollars, or transfer time.  $\Delta$

*Rainer McCown is president of Rhintek, Inc., a Data General system software ISV since 1977. He has been heavily involved in interconnecting PCs and DG minis. He can be reached at P.O. Box 220, Columbia, MD 21045; 301/730-2575.*

# A complete listing of the NADGUG software library

All NADGUG members interested in receiving the NADGUG software collection should send a 1,200-foot tape to:

Randy Berndt  
American Urological Association  
6750 West Loop South, #900  
Bellaire, Texas 77401

MV/2000 and MV/1400 users should send one **formatted, error-free** tape cartridge. Software contributions should be sent to the same address. Be sure to include your membership number. (Special thanks to Kevin Danzig for help with preparing the MV/2000 cartridges.) Allow 4-6 weeks for delivery.

People with AOS/VS rev 6 should send a 2,400-foot tape and specifically request DUMP\_II instead of the usual compressed version. The decompression program is rev 7 specific.

Please include a self-addressed envelope with sufficient return postage. In compliance with postal regulations, do not date the postage. Either disable the date printing completely, or set the date to "--" or zeros.

## Big Brother

Automatic log-off program written in Fortran 77. Donated by the U.S. Forest Service. 181 blocks.

## B.J.'s BBS contributions

This addition to the library consists of about 20 items, including various programs, documentation, and macros. Some of the more interesting items include the :SYSMGR benchmark suite, a continuous incremental backup, a clean-up file maintenance program, a program to find strings in files, and a type-backward program. 5,749 blocks.

## Black Jack

Kim Medlin of Data General presented this at the Las Vegas conference. 15,079 blocks.

## CRTEDIT

This is the old RDOS screen editor ported over to VS. 51 blocks.

## DBCHECK

This program checks the open status of an INFOS file and examines the check-pointing status of a file. 230 blocks.

## DUMpload

DUMpload is a Macintosh program

to dump and load AOS/VS-compatible dumps on a Macintosh. 140 blocks.

## ERP

A process-termination program developed by NASA and modified by Manville. In Fortran 77. 338 blocks.

## FILEMNGR

With this new version, you can move, copy, delete, view, and perform several other options faster. This is distributed as shareware. If you try it and continue to use it, you are requested to pay a registration fee. From Kim Geiger. 459 blocks.

## FTNCVT

This is a Fortran 5 to Fortran 77 translator. 287 blocks.

## Games

Games is a collection from various places. A new version of Conquest has been added as of April '89. 19,516 blocks.

## Glossary

Glossary is a program from John Grant that builds a list of words used in a document and shows where they are used. 416 blocks.

## IMSLUTIL

This is a collection of CLI macros, Cobol routines, and assembly routines callable from Cobol. By IMSL of Houston. 6,154 blocks.

## JAG\_UTIL

JAG\_UTIL consists of several programs: Filecount, Userspace, Scan, and Laminate. 1,501 blocks.

## Kermit

Kermit is a file-transfer protocol developed at Columbia University. Uses 9,328 blocks.

## Logout

Another auto log-out system. 246 blocks.

## Look

Look is used to view text files. It allows you to move forward and backward in a file. This program was donated by Data General. 438 blocks.

## Macros

This is a collection of macros from various sources. 452 blocks.

## MENUDIR

This is an initial user menu that can chain to other applications. It features a

password-control system. From the Fed SIG. 492 blocks.

## Misc Kerm

An expanded version of AOS Kermit, this now includes other versions of Kermit including DG/One Kermit. 6,298 blocks.

## Notify and Prior

Two contributions from Concept Automation. Notify tells you when a process has terminated. Prior lists the priorities of processes. 273 blocks.

## QHelp

QHelp is a tree-structured help facility. 2,277 blocks.

## RDOS Kermit

Now available. You must request the Kermit tape (rather than the library tape) to get RDOS Kermit.

## SKLSCRN

This is the Cobol standard entry screen featured in George Burns' article that appeared in the April 1988 issue of *Focus*. 385 blocks.

## Softtrans

This is a file-transfer protocol written in Fortran 77. It's used to communicate with proprietary PC communications packages. 496 blocks.

## Spell

Can check the spelling of a word or spell-check a document. Submitted by Richard Kouzes. 5,163 blocks.

## SWITCHES

SWITCHES is the GET.SWITCHES routine from John Grant's column in *Focus*. 1,297 blocks.

## TEX

Version 2.26a is now available. TEX (Terminal Emulator with Xmodem) is a terminal-emulation program written by David Down. He has recently revised the TEX software to include a command language. TEX is being distributed as shareware. At the end of 30 days, either remove it from your system or send the author a \$45 fee. 495 blocks.

## VT100KER

VT100KER is the VT100 emulator from John Grant. 1,135 blocks.

## Xfer

Xfer is a tape-conversion utility. 653 blocks. Δ

# Do you speak my language?

## SYNOPSIS

*Secret decoder rings, encryption engines, or plain data transformation: there are ways to streamline the process of translating character sets.*

J'avais un program a faire,  
Pour lire une fiche a memoire.  
But I still could not hack it,  
without a ?READ sub-packet.

I think that I can safely assume that not all *Focus* readers are bilingual, so I will provide a rough translation of this month's poem.

I had a program to do,  
to read a file to memory.  
Mais, ce n'`etait pas fait,  
sans un ?READ sous-paquet.

## Translations

Over the course of working with computers, most of us have had to translate from one language to another. In a few cases, the translations involve French, as in the example above, or Spanish, ASCII, EBCDIC, BAUDOT, etc. Artificial intelligence work is involved in human language translations, but most of the other translations are often simple substitution translations.

One of the system concepts that I like to demonstrate is the "lean and mean" principle—get as much done with as little as possible. This involves another type of translation when programming—human brain-power to CPU horsepower. Of course, one must not get overwhelmed by realities of scale and expend mega-





hours to code something that produces nano-WATTs of CPU work.

This month I would like to demonstrate how being lean and mean can help you reap horsepower from your computer without investing too much brainpower.

One translation requirement could be to produce an output file from an input file, in which the two files have different character sets. In a recent exercise, the translation needed to be from DGI to ROMAN-8, so that reports could be printed on a fancy laser printer. The translation itself wasn't really a problem, but it was taking too much time to run the macros, SORT/MERGE, and SPEED filters.

### Messages from the past

Investigation (and reading John Grant's articles) has taught us that a very efficient method for handling this situation would be "Let's write a program!" We all know that we must at least open the input and output files, read the input file, perform the translation, and write to the output file. By now, we also know that doing things one character at a time is probably inefficient. Therefore, we will not spend too much time thinking about one massive IF THE-INPUT-CHARACTER IS THIS THEN THE-OUTPUT-CHARACTER EQUALS THAT, ELSE IF THE-INPUT-CHARACTER IS . . . ad nauseam. This approach is very efficient because so little thought goes into the development of the code. However, it is very wasteful of CPU horsepower because of all the conditional testing.

When people translate things, we seldom use the approach of testing each entity. Translating text is not done by reading a word and testing it against each word in the two-way dictionary. With no prior knowledge of the text to translate, one would read a word, and then using the index in our dictionary, look up what the word means. Using the index is much more efficient than traversing the dictionary sequentially until we find a match.

Translating character sets can be handled simply by indexing in code. All you need is a table or an array in which to look up the output value for a specified input value. When translating, you would probably use some feature of the language you are using (character array indexing or character pointer arithmetic). It would now seem as if this is the minimal limit to

**Figure 1: Sample character set**

```
ABCDEFGHIJKLMNPOQRSTUVWXYZ,!.
abcdefghijklmnopqrstuvwxyz:?
```

**Figure 2: Sample translation table**

```
ABCDEFGHIJKLMNPOQRsTUVWXYZ,!
ibgdgfmhijklmnapqaccivwxyz:;?;
```

**Figure 3: Sample translation**

```
Source:
  Focus IS great.
Translated:
  Magic is magic!
```

the processing required to do the job. In one respect this is true, but not everything has been examined.

How many calls are we making to the system to read the data? Is it one per character, line, block, or page; or once for the whole file? Is it true that every character must be translated, and that we must issue the ?READ system call? Being lean and mean, we implement the system call directly from the language of choice.

Unlike some *Focus* readers, I do not know all of the parameters to the ?READ packet, so I index into the ?READ portion of the system call dictionary, and look up the details of that particular call. Lo and behold, there are some optional sub-packets. (Being lean and mean, AOS/VS lets a programmer invoke optional extensions to a system call. This is done by using additional programming sub-assemblies that snap on to the main packet.)

### ?READ and translate

If we look into the system call details, we find a "field translation packet extension." A few default transformations are available for dealing with ASCII ↔ EBCDIC, LOWERCASE ↔ UPPERCASE, and parity. You can also have a simple substitution translation. All that is required is the address of the array that was built when the "smarter" version of the program was written.

### Field translations

By reading the details of this packet extension, we find that AOS/VS performs the translation while the data is being moved into our destination buffer. If a raw translation is desired, then we could tromp through the file in large steps. In the case of converting a file from DGI to ROMAN-8, however, it was found that a

CR code needed to be added after every NEW LINE. This indicated that the program should issue data-sensitive ?READS, and that the CR character should be written to the output file after the translated data.

For a simple translation like DGI to ROMAN-8, we would specify in the extension that we want one translation to be done, starting at the beginning of the buffer; and that we want all of the characters in the input buffer to be translated, using the table that we supply.

### Example

To show how this would work, let us take a small character set that consists only of the alphabet and a few of the punctuation characters, as seen in Figure 1. Figure 2 is a translation table. The table is a simple positional remapping from the input characters' original position to give us the desired output characters. Given a source string in Figure 3, and using the translation table in Figure 2, we would come up with the resulting string in Figure 3.

A ?READ system call would have a full 256-byte translation table with the address of the table in the sub-packet and a request for only one translation, starting with the beginning and going for the entire length of the buffer's contents. The careful reader might notice that they are called "field translation sub-packets," which indicates that we can have more than one of them apply in a call, and that they can be applied to "fields" of data. When the fields overlap, the translations occur in order of appearance within the extension of the packet.

### Final word

Secret decoder rings, Enigma encryption engines, or just plain transformations of data are some of the uses of the field translation extensions to the ?READ call.

With any luck, my next article will get off of the topic of ?READ calls, and on to some other system concepts that have yet to be explored. Δ

---

*Michael Dupras is senior consultant for the Software Products and Services Division of DG Canada. He may be reached at Data General, 1827 Woodward Dr., Ottawa, Ontario, Canada K2C 0P9.*

---



## A good mystery for summer reading

### SYNOPSIS

*An MV/10000 running benchmarks gets "turned on" at certain speeds. If you like to play detective, see if you can figure out why.*

### :SUMMER\_VACATION

I figure that nobody reads the August column because everybody's off at Disney Land/World with their varmints. I know I'll be there; I've got reservations at Anaheim for late August to drag some visiting relatives from Italy around and get my once-yearly injection of serious techno-thrills from riding Star Tours. Plus I lost my official Star Tours cap a while back and I need to satisfy a physical cap fault.

So, given that we're all gonna be letting the system run itself during the month of August, I figure that this is no time for some long complex column on some useful technical subject. In other words, It's Multi-Topic Whimsy Time Again . . . .

### :MYSTERY

Unlike a certain contributor to one of

the other DG magazines who claims to be unstumpable—in spite of the fact that about 50 percent of the answers he publishes to submitted questions are completely wrong—I'm frequently stumped and I have no shame when it comes to admitting it. So I'm going to relate a problem to you that currently has me stumped and see if any of you can come up with a solution. For those of you not conversant at the hardware level, this will be a good case study on the detective work involved in tracking down obscure problems.

A client of mine has his very own operating system. Yeah, I know that this is roughly equivalent to building your own car because you don't like anything that's commercially available, but we can debate that later. Anyway, this little operating system was originally designed for DG's Nova series of computers and their clones. The problem arose when the op-

erating system was recently ported to an MV/10000 and the client found that it ran slower than the Eclipse S/280 version by about a third. The port involved minor changes to modify the MPPU code from the S/280 to use the ATU instead on the MV/10000. The bulk of the code is still plain old 16-bit Nova instructions, with a smattering of 16-bit Eclipse instructions.

In order to make trouble-shooting the problem simpler, a short (100 instructions) 16-bit benchmark was devised to measure the relative speeds of the processors. The benchmark simply loops a million times running eight identical copies of an eleven instruction test. A bootable version of the benchmark was then prepared and copied to tape with TBOOT on file 0. Here are the results of running the benchmark:

S/280: 29 secs  
MV/10: 38 secs

The times were obtained by a human sporting an extremely accurate Timex with an incredibly precise sweep second hand.

I'm purposely not going to list the benchmark instructions because I think it distracts from the analysis. Bear in mind that the client's operating system also runs slower on the MV/4000, so that pretty much eliminates anything specific to the simple benchmark.

A version of the benchmark capable of running under AOS/VS was coded up and run; it took 18 seconds, or slightly less than half the time of the standalone benchmark. The fact that the time was almost exactly a factor of two improvement may be a clue. Then again, it may just be a coincidence.

My first suspicion was that perhaps the fact that the benchmark was running in "physical" machine state was a problem. I guess I ignored the fact that the operating system sets up the ATU with a simple logical↔physical page translation and turns on the ATU. Anyway, a small piece of code was added to load a default page table set into the ATU and turn it on.

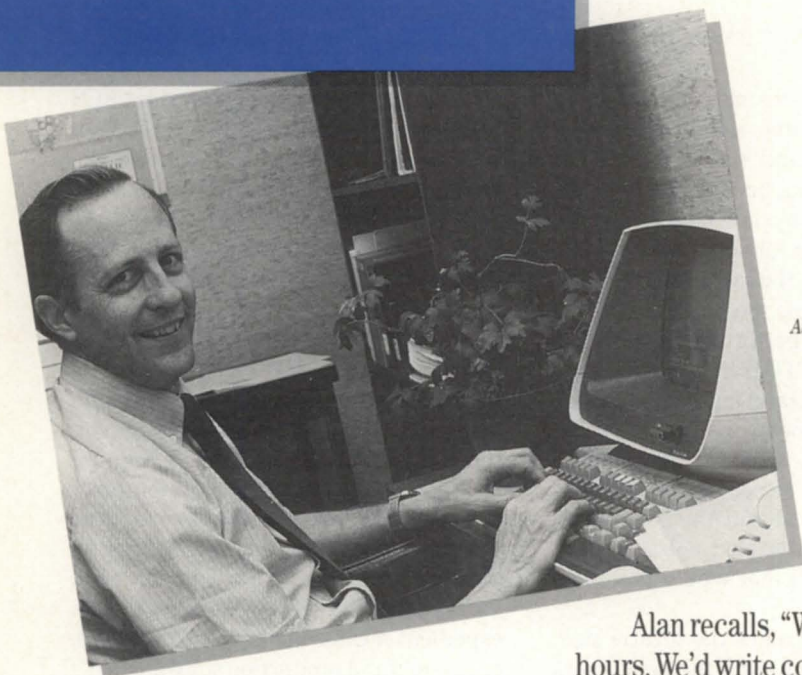

*Alan Ashton, in the early days of WordPerfect, working at a Data General terminal.*

## WordPerfect:<sup>®</sup> It all started on the Data General.

WordPerfect Corporation's relationship with Data General goes back to the very first keystroke.

Alan Ashton and Bruce Bastian had arranged with Orem, a small town in central Utah, to write a word processing program for the city's Data General minicomputer.

Working around the clock in the basement of city hall, Bruce and Alan huddled over a Data General computer. They were developing what would become the new industry standard in word processing. WordPerfect<sup>®</sup>.

Alan recalls, "We worked long hours. We'd write code until two or three in the morning, or as long as one of us could stay awake."

And while they developed the program by night, they tested it by day on the city staff. The clean screen, speller interface, and other features are a direct result of listening to what the secretaries wanted.

*Under the direction of Bruce Bastian and Alan Ashton, WordPerfect has grown from Satellite Software, a two-man development team, to WordPerfect Corporation, the world leader in word processing.*

This pattern of development continues today. With WordPerfect Corporation's support system, users not only receive friendly service, but they are making suggestions that shape the future of WordPerfect products.

Data General, naturally, is one of our strongest platforms. And we continue to listen to DG users. We now work with CEO, and we have developed other tools such as M-Edit, a macro editor, and P-Edit, a program editor. These smaller scale editors tiptoe around heavy DG programs for quicker, lighter editing.

In addition to WordPerfect, WordPerfect Library also originated on the Data General and introduced our electronic mail and calendaring programs.

So from its beginning in the city cellar, to its position as the world leader in word processing, WordPerfect offers you powerful features and the best support in the industry.

"We aimed high from the beginning," Bruce explains, "and we kept our standards high all along."



**WordPerfect**  
CORPORATION

1555 N. Technology Way · Orem, UT 84057  
Tel: (801) 222-4100 · Telex: 820618 · FAX: (801) 222-4477

## DG & COMPATIBLE BUY • SELL • LEASE

### CPU

MV/15000, 20000  
MV/10000  
MV/8000  
MV/7800  
MV/4000, 4000DC  
MV/2000  
NOVA 4-C, S/20  
S/140, S/280

### MEMORY

for all MV &  
ECLIPSE  
for all NOVA &  
MICRO

### PRINTERS

4320 55CPS LQ  
4589 SERIAL  
4422 SERIAL  
OKIDATA 192, 292  
HP LASER JET II

### DESKTOP

DG/10, 20, 30 PKG  
DISK UPGRADES  
USAM-4, USAM-1  
CARTRIDGE TAPE  
MEMORY

### COMMUNICATIONS

IAC-8, IAC-16  
TCB'S  
COM BASIC I/O  
ATI-16, AMI-8  
ALM-8, ALM-16  
MCP-1 W/TCB

### DISK/TAPE

354, 592MB  
96, 192MB  
73, 147MB  
10, 12.5, 20, 25MB  
6231 CART N/E  
6026, 6123, 6125  
6299, 6300, 6021

### CRT'S

6053, D-100, D-200  
D-210, 211, 410, 460  
D-214, 215, 411, 461  
D-216, 412, 462, 470

### COMPATIBLES

ZETACO CDC  
FUJITSU SCIP  
DATARAM STC

### SPECIAL

★★★★

DG/10, 128KB, DUAL FLOPPY,  
MONO MONITOR....\$495

### AMES SCIENCES, INC.

2 EAST MAPLE AVE. TRAPPE MD 21673  
(301) 476-3200 • FAX 301-476-3396

Circle 1 on reader service card.

## Why blast your CPU...

# TurboTran (XMODEM/YMODEM)

Error-Free  
file transfer  
that won't drive your  
system into the dust!

### TurboTran Includes:

- Checksum & CRC Modes
- Integration with CEO
- PC Support Utilities
- AOS & AOS/VS Systems
- Many Other Extras!

## \$225

30 Day Risk Free Offer

### Data Bank Associates, Inc.

20010 Century Blvd., Suite 104  
Germantown, Maryland 20874

(301) 540-5562

FAX# 301/540-8105

Circle 16 on reader service card.

## SYSTEM MANAGER'S LOG

The standalone MV/10000 speed was still 38 seconds.

One of the problems with complex architectures like that of the MV/10000 is that the various and sundry caches can play tricks on you. So next I speculated that the cache may not have been performing up to par for some reason. Having no way to test the cache effectiveness, I decided to cripple the machine and see if the benchmark performance degraded. I used the SCP-CLI DEGRADE command to turn off the ATU and instruction caches. This time the benchmark ran in 59 seconds. Obviously, some caching was in effect during the 38-second runs. In retrospect, I wish I had run the benchmark with each cache disabled one at a time. I'm not sure what that would have told me though.

Anyway, here comes the bizarre part. Next we tried relocating the benchmark to different places in memory and running it. The benchmark consists of about eight words of data separate from the code. Here are the results of this test:

Data	Code	S/280	MV/10
50	460	29	38
50	1,000	29	38
50	2,000	29	38
50	3,000	29	38
50	4,000	29	18
50	5,000	29	38

Weird, huh? Wait; it gets weirder. The procedure for running the benchmark at the various locations was to BOOT 22 to get the benchmark loaded from tape, then use the SCP-CLI to enter a small (eight-word) program at location 100 to relocate the benchmark to the target address and run it. As soon as we hit the high speed version at 4,000 we went back and tried to run the previous copies at 1,000, 2,000, 3,000, and 5,000. They now ran in 18 seconds, too! Something about running the copy at 4,000 "turned on" the MV/10000, and then running copies anywhere else after that "turn on" would result in fast times. But as soon as we re-booted from tape, the MV/10000 "turned off."

Later testing showed that several other addresses were "magic" also—specifically 10,000 and 40,000. There may be others, but we didn't search for them.

So, Watsons, what's the secret? Specifically, what needs to be added to the initialization logic in my client's operating

system to get the MV/10000 "turned on?" What's the underlying mechanism that caused this whole thing? How does AOS/VS get the MV/10000 into fast mode (it must be in fast mode, the stand-alone version of the benchmark proved it)?

If this little problem makes you wonder about the accuracy of most benchmarks on complicated processor designs, it should.

### :THINGS\_TO\_COME

It probably doesn't come as much of a surprise if you've been reading my columns for very long that I have little regard for the increasingly common practice of coding system software with little attention paid to the underlying cost in machine resources. I have no problem with coding "Bic" software using the most expedient means available (e.g., a 4GL), but system and production software that's going to get executed zillions of times during its lifetime deserves more attention to performance.

Until now, there have been only two major causes behind the tendency of software resource consumption to outpace the availability of higher speed processors and advances in compiler optimization technology.

The first cause has to do with the increasing tendency to write system software in high-level languages using inexperienced programmers, and then skip the step of having a skilled optimization team go over the finished product to identify key bottleneck areas to be re-coded or redesigned in light of their cost.

The second cause has to do with the mindless quest to automate the job of system and production program development using application generators and data base tools that attempt to hide the physical details of what's actually happening from the programmer (presumably because the programmer is too stupid to handle it). When you separate actions from their effects, the results are predictable; ask anyone who's ever been a PFC in the Army.

The new cause that's starting to rear its ugly head is related to the crushing cost of "layered" software. Layered designs are almost inevitable in the world of multi-vendor hardware and software situations (e.g., writing software to run on multiple manufacturer's systems, or writing software to support multiple file systems).

So far, this cause has yet to become a factor on proprietary systems such as AOS/VS because portability is not an issue.

All of this was brought home to me recently by an apparently innocuous review of a new software product for MS-DOS, and an announcement by IBM in the trade press that went mostly unnoticed.

The reviewer was describing his experience of attempting to test the new port of Adobe's incredibly successful Illustrator package from the Mac to IBM-compatible PCs. The package is one of the first to use the new Presentation Manager interface to the OS/2 operating system.

The first problem cited was that the software took minutes to respond to commands if the PC had any less than 2 MB of physical memory available. The second problem cited was that even with sufficient(!) memory, commands still took 10 or 15 seconds on anything less than a 16 MHz processor. In fact, the reviewer claimed that a 16 MHz processor was "barely tolerable," and that a 25 MHz processor was much more reasonable.

A check with a friend who has contacts inside Adobe revealed that the approach taken by Adobe for the OS/2 port was to take the Mac sources—which were coded mostly in a high level language with key parts coded in assembly specifically for the Motorola 68000 series engine in the Mac—and convert them to a portable format that is theoretically machine and system independent. Add the incredible overhead of the Presentation Manager, also coded in a high level language with little apparent regard for memory and processor consumption, and you end up with what the reviewer experienced.

The announcement by IBM that went pretty much unnoticed was related to the cancellation of a major programming project instigated by IBM in an attempt to accomplish two objectives: to demonstrate the efficacy of its new System Application Architecture programming standard, and to become a force in the mainstream financial application software industry currently dominated by third-party suppliers such as Management Science Associates.

IBM threw in the towel after several thousand person-years of effort and an investment of about \$60 million because

of two simple problems: the thing ran slower than maple tree sap in December, and the size and complexity of the layered code was more than a single human could grasp in one lifetime.

## :THINGS\_TO\_COME:WRAP\_UP

This may seem like a long leap of logic, but a lot of what I've just described is actually a good reason to cheer up. To

my mind, it explains why there will always be a place for proprietary systems, whether Unix ever gains a significant foothold in the marketplace or not. (Are you aware that Unix accounts for only 15 percent of the installed systems on this planet, even after 10 years of supposedly being on the brink of taking over?)

The effect is obvious: proprietary systems will always offer more bang for the

# For Sale

MV/20000 MOD 1 CPU

MV/15000 MOD 10 CPU

MV/15000 MOD 20 CPU

## UPGRADES:

- UVIK-G IOC2 Upgrade for MV/20000
- UVIK-H IOC2/3 Upgrade for MV/20000
- UVIKW-A MV/20000 MOD 1 to MOD 2
- U15810 MV/15000 MOD 8 to MOD 10

# BUY SELL TRADE

**SYSTEMS • PERIPHERALS • COMMUNICATIONS • SPARE PARTS**

Orders received by 7pm EST usually shipped the same day  
from Los Angeles International Airport.



**CATALINA  
COMPUTERS, INC.**

1001 W. Arbor Vitae St., Inglewood, CA 90301

**(213) 215 - 0641**

FAX # 213/649-1065

Circle 4 on reader service card.

buck because there is less need to squander resources in pursuit of the elusive portability god, and the overhead of layering will be less likely because the manufacturer specifies a single interface optimized for the manufacturer's own proprietary hardware and software. For example, the only user interface on AOS/VS is via PMGR using the Screenedit I/O facility.

As long as there are people out there needing cost-effective high performance computer systems offering efficient software packages, and as long as they don't care what the underlying engine is (CISC vs. RISC, AOS/VS vs. Unix), providers of packages on proprietary systems will have no shortage of customers, and portable types trying to horn in on their market will find themselves at a prohibitive

performance disadvantage.

## :RETROSPECT

The macros in my June column suffered the usual butchering at the hands of the typesetting software. The galleys that were sent to me for proofreading were minus the figures, which showed up as empty boxes. Anyway, I spotted a few problems in the speed macros where multiple adjacent spaces got collapsed into a single space and single spaces got collapsed into spacettes. If you tried to type the macros in from the figures and couldn't get them to go, I suggest you pick up copies of them from the BBS and forget trying to key them in.

Since June's comments about Infos 5.00, several other users have called to say that they also installed it and saw dramatic results. However, one caller said that he was experiencing an occasional abort of the Infos global server with an "internal consistency error." This may be an isolated problem because this user has a very complex index structure. Luckily, all of our Infos files are absolutely vanilla-flavored single-level, single-key ISAM. Occasionally we splurge and use alternate keys, but multi-level keys are a rarity. Maybe that explains why we haven't had any problems. It also explains why our data bases are faster than bunny rabbits compared to some of the varicose vein style index designs I've seen.

## :LAST\_CHANCE

The NADGUG National Conference is coming up next month, and so far we've received only one entry in the CPU squandering contest. If you can't come up with an entry, I might have to submit a few myself and award the trophy to me (I wisely didn't include a clause prohibiting employees, relatives, girl/boy friends, drug dealers, and other :SYSMGR hangers-on from entering the contest).  $\Delta$

*BJ is the President of B.J. Inc., a San Francisco-based consultancy specializing in system auditing, system management, and performance analysis. :SYSMGR is a division of B.J. Inc. BJ can be reached at 109 Minna St., Suite 215, San Francisco, CA 94105, 415/550-1444. The :SYSMGR bulletin board number is 415/391-6531 (1200/2400 with optional MNP level 4, CHAR/605X/AUTO-BAUD) or 415/550-1454 (voice).*

# AXIS

## The ICOBOL Developer's Solution

Compiles ICOBOL programs on most popular computers under most popular operating systems.

AXIS... for portability, productivity, profitability.

Wild Hare Computer Systems, Inc.  
P.O. Box 3581  
Boulder, Colorado 80307-3581  
U.S.A.

TEL: (303) 442-0324  
FAX: (303) 440-7916

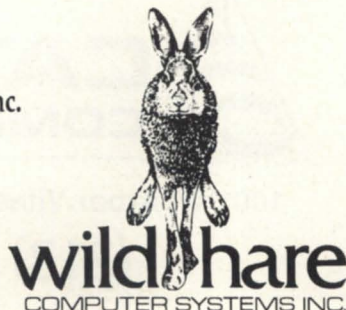

Circle 70 on reader service card.

# Some tape is reel attractive —even magnetic

## SYNOPSIS

*The author continues a discussion on backups by looking at various off-line storage devices available for use with DG systems.*

Today's technology provides many solutions for off-line storage. The short-term options are almost exclusively implemented with magnetic tape. For this article, I will use the term "magnetic tape" to mean only the standard reel-to-reel magnetic tape. I will use the term "tape cartridge" or "cartridge" when referring to the myriad different cartridge tapes.

### Tape is widespread

By far the most common medium for data storage is magnetic tape. There are several reasons for this, the main ones being that it is inexpensive, and that it can be used with nearly every brand of computer. It is the closest thing to a standard in the computer industry. I have yet to receive a tape that I couldn't read and process on my MV/4000. (By the way, this says a lot for the quality and flexibility of DG's interface in both Cobol and CLI.)

### Tape is cheap

How cheap is magnetic tape? For full-sized MV systems (those with 15-inch controller boards), for less than \$500 you can get a used 1600 BPI tape drive subsystem (model 6125) that can stream 20 MB of data to a \$12 tape in about 10 minutes. For most smaller systems, this is an acceptable solution.

My favorite drive is the 6026 dual den-

sity drive. Although not a streamer, it performs well, dropping over 40 MB to tape in 15 minutes or less using DUMP\_II. Furthermore, its performance is not compromised by non-streaming software, and it makes a standard systape on an empty MV/4000 in about six minutes. Again, this is an inexpensive solution, since used subsystems can be found for under \$3,000. Users of small DC systems will have to shell out a little more (\$6,000-9,000) for a standard magnetic tape unit. Every user I know who has done this has been pleased with the results.

### 6250 tape is almost as cheap

Users of large systems (1 GB or more) may find the 1600 BPI format limiting because it takes too much time to back up the system and, more importantly, it takes too many reels of tape. Many have opted for the 6250 BPI tape units. These start at \$17,500 for third-party and go to \$25-30,000 for a new DG unit. They perform about eight times better than the old faithful 6026 unit, copying 150-160 MB of data to a 2400-foot tape in as little as 10-15 minutes, depending on the utility. I think any large user should have at least one of these units on each system.

### "Cheap Tape" not so cheap

The standard tape cartridge unit is the 20 MB. DG priced the unit at \$1500 retail and made it the main off-line media of the MV/2000 for two reasons: it is cheap and small. Had DG configured the system with a reel-to-reel tape, it would have doubled the physical size of the machine and added \$5,000 to the retail price. But there is a flaw with the "cheap tape": it redefines the meaning of slow. Backing up 20 MB of data takes close to an hour. If you start having soft errors on the tape, it could easily take two or more hours. Thus, to back up your almost full 160 MB disk, it takes at least eight hours. The "cheap tape" ends up costing a fortune in operator time. (Most of this section also applies to the MV/1400 and MV/1000.)

**Better than "cheap"**

We have found two solutions to this problem. One is to add a standard magnetic tape unit. They are available both from DG and third-party sources for \$5,000-9,000. They install in minutes, and provide faster and more reliable backup, as well as a way to communicate with the rest of the world via 1600 BPI tape (some units also provide 800 and 3200 BPI).

Another solution, available for about \$3500, is a tape cartridge unit that emulates the standard tape unit. We have them at two sites and they can move over 100 MB to cartridge tape in about 40 minutes. This is the most economical way to back up an MV/2000. I still have a personal preference for the full-sized reels, despite their cost, because they provide virtually unlimited communications ability.

**Giant economy size cartridges**

Some users of medium-to-small systems (using 200-300 MB of disk) eventually get tired of backing up on their 6026 in 1600 BPI. (So what that it only runs 10-15 minutes per tape (with rewind), and only takes 5 or 6 reels?—it is starting to be a lot more work than pleasure.) For these users, the Megatape unit is ideal. Originally available only in a 300 MB cartridge, it is now available in capacities up to 1200 MB. Also, DG sells the 600 MB unit as model 5080 for users who require

# Why Join NADGUG?

## Reason #6

# Strength in Numbers

As an individual Data General user, you may have little chance to have your system concerns heard by the right people at DG. You need to get to the people that can make things happen. The North American Data General User Group talks to these people and is listened to. This collective voice of users cannot be ignored or put on hold. There is definitely strength in numbers! NADGUG has several channels for you to communicate with Data General. On the

local level, regional and special interest group meetings are an excellent place to meet Data General representatives and have one-on-one conversations. The Executive Advisory Board is the official voice of NADGUG to Data General.

**NORTH AMERICAN  
DATA GENERAL  
USERS  
GROUP**

NADGUG officers and Focus are two more ways to get your views heard. Become a part of the collective voice and participate in the two-way communication with Data General, join NADGUG today!

**1-800-USR-GRUP**  
512/345-5316 (outside U.S.)

*Removable disk is making a comeback, but now, instead of removing the disk platters, you remove the entire sealed disk and servo mechanism*

a single vendor system.

One of my clients can dump his entire Argus drive (about 100 MB of data) in about six minutes on a single tape! The cartridges cost about \$150 each, and the manufacturer recommends replacing the tape every 50 uses for a respooling charge of about \$50. On a per megabyte basis, the tape costs about the same as standard magnetic tape. (For more information about Megatape, see Tim Boyer's article on page 65.)

**A few last thoughts about tape**

Of the many other types of tape cartridges, the most promising are the video tape-based units. I have heard of one unit available in the mini world that backs up multiple gigabytes of data in a little over an hour, using a standard \$4 video tape and a slightly altered home video unit. I'm not sure if these units are available for use with DG equipment, but I hope that if they are, someone will call and tell me all about them (or at least send in the



reply card with the manufacturer's phone number.)

**Removable disk**

Back in the 16-bit days, before sealed disk technology and speedy streaming tapes, using multiple disk units with removable packs was the preferred method of backup. It allows you to copy entire disk images in minutes, compared to taking an hour or two for a tape dump. You have the option of retrieving either the entire disk or individual files.

Removable disk is making a comeback, but now, instead of removing the disk platters, you remove the entire sealed disk and servo mechanism. I'm watching for this to become available on DG, because there are at least three third-party manufacturers who make it possible on DEC. They use the same 5-inch sealed disk canisters as the microcomputers. This is really a plug-in disk unit, as opposed to true removable media. Of course, it doesn't matter how you store the data off-line; what is important is that you do.

This type of unit would be ideal for my work environment. We normally work on only two or three clients' systems at a time. We could devote one canister to each client, storing the software and data off-line. We could simply mount the client's canister when that information was needed. Backups would be made to duplicate canisters or tape.

**1000 points of light**

Laser disks have had one major problem in the computer industry. Since stored data is almost always subject to change, how could this non-erasable, non-re-writable medium be used? At one time, there were discussions about using laser drives to eliminate system generation tasks. This would simplify the distribution of operating systems, because there would be no need to custom generate a system to define your configuration. Your system's configuration would be loaded during the boot process. This strategy, however, never proved viable in the mini world.

Recently, a number of more practical uses have started to appear. Zetaco was the first company to make a magnetic disk emulator that is truly plug-compatible and transparent to AOS/VS. It has two parts, the laser disk and a sealed 5-inch magnetic disk. All writes to the drive are handled by a Winchester disk drive.

Only after the drive becomes full is anything written to the laser disk. Since the sealed disk provides an approximate 80 MB buffer to the permanent write-once memory of the laser disk, it is generally sufficient to allow only "finalized" data to get to the disk.

One client uses a laser disk unit as an archive disk for CAD/CAM drawings, and only copies data files to it after a

design is complete. Once a design is put into production, it is no longer subject to revision. Not until the laser disk is full (1 to 2 GB for DG models) will the directory information be written on the laser portion. At that point the disk does become a read-only volume.

**Mayday! Flashback**

One of the topics I discussed in my

**IN  
CASE OF  
EMERGENCY**



**CALL  
FAST TRACK  
SYSTEMS, INC.**

**FAST TRACK is best equipped to provide disaster recovery services to your company**

**Look at the facts:**

- Multiple hot sites for better geographic coverage
- Fully equipped locations: Manhattan, Brooklyn NY, and Chicago
- Largest base of installed equipment, and most equipment per subscriber of any Data General disaster recovery firm
- Facilities manned 24 hours a day, 7 days a week by trained operators
- Data General VAR authorized to provide disaster recovery services

- The only Data General hot site facility with its own off-site high security data storage vaults offering 24 hour, 7 day a week courier service
- Fully equipped computer room, office space and conference room facilities dedicated to disaster recovery subscribers
- On-site inventory of hundreds of modems, multiplexors, and terminals
- Private communications network available in most major U.S. cities
- In-house Data General communications expertise ready to provide solutions to your networking needs

**Before disaster strikes, you need FAST TRACK SYSTEMS™**

**(212) 422-9880    (800) 633-3282**

Data General has qualified FAST TRACK SYSTEMS as a provider of **DG/hot site** services based on FAST TRACK having met criteria established by Data General.



**FAST TRACK SYSTEMS, INC.**

61 Broadway New York, NY 10006

FTS is an independent company providing its disaster recovery services for users of Data General equipment.

Circle 34 on reader service card.

# DATA GENERAL

BUY • SELL • TRADE

★ SPECIAL 6300 1600/6250 BPI Tape S/S..... \$11,900★

**CPU's:**

MV15000 Mod 10 .....	Call
MV10000 w/BBU .....	\$19,900
MV7800 w/4MB .....	4,900
MV4000 w/o Mem .....	1,500
MV2000 w/2MB 70MB Disk, Cart .....	4,900
MV8000 9600 Series w/2MB .....	2,500
MV6000 w/2MB .....	1,900
Eclipse S/140, w/256K, 16 Slot .....	1,250
DT Mod 10/Mod 20 w/256KB 15MB Flpy .....	990
Nova 4/X w/256KB, 16 Slot .....	990

**MEMORIES:**

8990-D 16MB MV20/MV15 Mem .....	\$15,900
8871 8MB MV4/MV10 Mem .....	5,900
8870 4MB MV4/MV10 Mem .....	2,500
8765 2MB MV Universal Mem .....	790
8708 2MB MV8000 Mem .....	790
8687 256KB S/140 Mem .....	290

**DISKS AND TAPES:**

6236 354MB ARGUS S/S .....	\$5,900
6161 147MB Disk S/S .....	1,790
6061 192MB S/S .....	990
6239 592MB ARGUS S/S .....	11,900
6123 Micro Streamer .....	990
6026 800/1600 BPI Tape S/S .....	1,390

**CRT's:**

D214 .....	\$325
Dasher D410 .....	325
6169 Dasher D211 .....	295
6168 Dasher D210 .....	250
Dasher 460 .....	295

**COMMUNICATIONS:**

IAC16 .....	\$3,100
IAC8 .....	1,250
ISC II .....	690
4340 AMI8 .....	290
4342 AT116 .....	390
4206 MCA .....	450

**PRINTERS:**

M200 340CPS .....	\$690
4327 300LPM Band .....	1,400
B1000 Data Products .....	4,500
6194 TP2 Enhanced .....	950

**CONTROLLERS:**

Floating Pt. for S/140 .....	\$790
25MB, 10MB, 20MB, Controllers .....	200
Comm Basic I/O .....	690
6026 800/1600BPI Controller .....	690



**COMPUTER WHOLESALERS**

MARK BRADT      404-455-4542      FAX 404/457-5841  
3246 Marjan Drive      Doraville, Georgia 30340

Circle 11 on reader service card.

# EMULATION

**IS SOMETHING MISSING FROM YOUR DG TERMINAL EMULATOR?**

**Introducing EXACT DG Terminal Emulation**

@Con/PC and @Con/PC Plus are the first programs to allow your PC to emulate all the features and functions of DG terminals (D210 through D411).

**Blazingly FAST File Transfers, Too**

@Con/PC Plus uses ConX, its own file transfer protocol, which is up to ten times faster than competing products. XMODEM and ASCII file transfers are also supported for added flexibility.

@Con/PC, only \$95.  
@Con/PC Plus, only \$149.

Distributor inquiries welcome. Special bundling license available to VARs.



- 132-column compressed screens
- True underlining on EGA/VGA monitors
- Realistic emulation of all attributes
- Baud rates to 38,400
- 15 function keys on the PC keyboard
- Mouse support
- 120-Command macro language
- Memory resident mode
- Runs under DESQview™

**Demo Disk \$10.**  
Deductible from Purchase Price  
Call 516/283-4994

33 Flying Point Road • Southampton, NY 11968

Circle 35 on reader service card.

My May column has caused me (and apparently some other people) a few headaches. Due to a number of phone calls from users and DG marketing personnel, I feel obligated to clear the air, especially since I had no desire to generate ill will with the DG marketing or sales forces.

My May column included a report on a discussion I had with Frank Keaney, then vice president of tactical marketing for DG. We discussed a solution for licensed sites that purchase a one-shot upgrade fee and then encounter a problem with that revision.

The current procedure allows users to purchase a specific revision for a flat fee. I pointed out several drawbacks to that type of upgrade program, including lack of recourse for users if a specific revision can not be used at their site. I then pointed out a *possible solution*, namely, that the one-shot purchase could also include the remaining updates to that revision. So in order to make one thing perfectly clear, read my keystrokes: *this is not DG procedure*. At this time DG has no plans that I am aware of to consider altering its procedure. Hence, if you make the one-shot purchase upgrade, you must use that specific update or try again with another P.O.

*(Editor's note: How things change! Since this column was written, Keaney has resigned from Data General, and the company has reversed its policy concerning Software Subscription Service.)*

**Cobol 3.30 vs. 3.20**

Egad! I have found another problem with Cobol. The line:

01 WS-VARIABLE      USAGE INDEX  
   VALUE 200.

compiles correctly with Cobol 3.20 but gives a compile error under 3.30. I haven't read the entire release notice but I can't imagine anyone *wanting* to have that removed.      Δ

*Jim Siegman is a contributing editor to Focus, chair of the NADGUG Audit Committee, and treasurer of the Chicago Area Data General Users Group. Send comments or questions to him c/o Datamark Corp., 3700 W. Devon, Suite E, Lincolnwood, IL 60659; 312/673-1700.*

# Less is more

## SYNOPSIS

*The unit looks good, the front panel is efficient, and the footprint is so small that the cables weigh more than the drive. Our reviewer tests the Megatape GT-88 tape drive.*

I'm trying to figure out how to start this review of Megatape's GT-88 tape drive. I feel like Jon Lovitt's liar on the "Saturday Night Live" television show. "You see, I just got this tape drive. It holds 200 megabytes . . . no, 500 . . . no, 2 gigabytes. Yeah, that's the ticket, 2 gigabytes. On one tape. No, a cartridge tape. An 8-millimeter cartridge tape. And it costs 25 . . . \$12,500. Yeah, \$12,500, and that includes the controller. And it transfers files faster than a 6026. Twice as fast. That's the ticket—it holds 2 gigabytes on an 8-mm cartridge tape, costs under \$13,000, and transfers data at twice the rate of a 6026 drive."

I know it sounds too good to be true, but that's what I'm reviewing this month. The Megatape GT-88 is a 2 GB tape backup unit that uses 8mm cartridge tapes. If you're already using a Zetaco BMX-2, the unit plugs right in and is configured as a Megatape MT-500. If not, the whole subsystem is available for \$12,500. When our shipping department brought me the unit, my first reaction was to ask, "Where's the rest of it?" The unit is small—14-1/2 inches x 8-1/2 inches x 4-1/2 inches—and weighs only 16 pounds. This is the first time that I could show off a new piece of equipment by tucking it under my arm and walking from office to office.

The front control panel is elegantly simple. There are only two buttons, On-line and Eject. On the GT-88/2, there is an additional switch that allows you to change back and forth between CPUs.

This way, you can have two machines sharing the unit. From a user's viewpoint, I like this minimalist approach. The rewind button always seemed superfluous, because I issue a rewind command from the console. Separate On-Line and BOT buttons are a waste, too—why would I want the tape at the BOT if I didn't want it on line?

The GT-88's insides look like that of a VCR. The tape is passed by a rotating head at a shallow angle. In this way, the actual track written is much longer than the width of the tape. Each track consists of 8,192 bytes of user data, along with 3200 bytes of ECC data. This length of ECC will enable burst errors of up to 264 bytes to be corrected. Also included on the track are 1200 bytes of servo data to enable precise head-to-track alignment, so that the data recorded on your GT-88 can be read on mine.

The configuration switches are handier than the original MT-750, but still not very accessible. You have to turn the unit over to get to them—fortunately not too much of a job with a 16-pound tape drive. The major use of the switches is to set the transfer rate. You want to set the unit to transfer as quickly as possible, but due to the nature of a streaming drive, you lose a lot of time if the tape has to do much repositioning. To help avoid excess repositioning, the unit includes 1 MB of cache memory.

## The test

So the unit looks good, the front panel is efficient, and the footprint is so small that the cables weigh more than the drive. But how well does it work?

I created a directory with about 50 MB of history files. This size was chosen so that I wouldn't have to take the rewind time of the 6026 into effect. The GT-88 dumped the files in 4-1/2 minutes, or better than 11 MB/minute. My 6026 took over 9-1/2 minutes. To load files back, the Megatape unit used 7 minutes, while



the 6026 took 9-1/2. Since this was a directory with a small number (21) of large files, I decided to try dumping my programs directory, which has 13 MB in 900 files. The GT-88 and the 6026 both ran at almost 5 MB/minute, so the type of files that you're dumping can make a difference. Practically, however, most of your backup space will consist of large data files rather than small program files, so the GT-88 should have a decided advantage. If you're doing multi-reel dumps, the rewind time alone gives the GT-88 an edge.

To see what the capacity of the unit really was, I kept dumping everything to tape using DUMP\_II and the STAT switch. When I was finally out of room, STAT reported 2.06 GB dumped to tape. Close enough.

### Closet space

The 8mm cartridges themselves are just a little larger than an audio cassette, and cost somewhere in the \$10-12 range. In my case, with about 400 MB of data on

disk, I can keep an entire week's backup on one cartridge! For an outlay of about \$600, I could now, if I wanted to, keep a backup of all of my disks every day for an entire year in about the same space as 10 tape reels. Obviously I won't, but it certainly has made doing backups at night easier.

Instead of mounting four or five tapes per night, we now load a cartridge once a week. I have an ICobol program that converts the day of the week to a number, and writes it to `TODAYS_NUMBER`. A macro then does a dump each night to that tape file—`X DUMP_II/BUFF=32768 @MTC0:[TODAYS_NUMBER]`—and at the end of the week, I've got a whole week's backup on one tape. I can tuck it in my pocket, and I have the perfect form of off-site backup. And my wife doesn't yell about all of those bloody tape reels in the top of the coat closet. For those of you whose biggest gripe about the previous Megatape units was the price of the cartridges, there goes your last excuse.

There's a niche for an entrepreneur here, by the way. The cartridges are too large for an audio cassette rack, and too small for anything else. Somebody needs to come up with a storage rack for these things. Send me one after you've made your first million.

Maintenance on the GT-88 is minimal. Megatape sells a special cleaning cartridge that is to be used once a month or every 32 GB, whichever comes first. A cartridge is good for three cleanings, and a package of four—sufficient for a year's worth of preventive maintenance—is \$100. Don't buy regular 8mm cleaning cartridges; use of them will void the warranty.

### Documentation

The biggest problem that I had with the GT-88 is documentation. The manual that I originally received is, to put it nicely, minimal. To put it not so nicely, it's simply horrible. There's plenty of technical information, but little or no practical information.

When I get a new piece of equipment,

# Introducing EO-322

## Eraseable Optical Disk

CacheBox controlled access as low as 7 ms.  
for all of DG's MV/and AViiON Computers

- Removable cartridge stores 322Mb on each side, 644Mb/cartridge total.
- AOS/VS, AOS/VS II, DGUX, DG RDOS and other operating systems supported.



**Delphi Data**

(714) 279-7955 Fax: (714) 279-7957  
9069 Cajalco Road, Building 1 • Corona, CA 91719

Call for your  
VAR pricing.

AOS/VS, AOS/VS II, DGUX, DG RDOS are registered trademarks of DGC.

Circle 28 on reader service card.

my primary need is to know how the switches have to be set in order to hook it up to my system. I don't necessarily need to know what the switches are *for*—just where they should *be*. The manual that originally came with the GT-88 explains the purpose for each switch, but contains no machine-specific information on how to set them. It wasn't until I was sent a new set of PROMs that Megatape included a two-page "Tek-Tip" that showed the Data General settings. This week I received version two of the manual. It included the switch information, but little else.

When I went to use the Zetaco set-up tape, I discovered that there wasn't a listing for a Megatape GT-88. I used the MT-500 settings, which worked, but I would have appreciated a note in the guide telling me to do so. The manual also doesn't say which tape unit the GT-88 is emulating. I originally set it up as MTD0, which resulted in very quick dumps, and consistently failing loads. I kept getting "Indecipherable dump formats." Switch-

ing the tape to MTC0 has made all of the problems go away.

The supplied manual was very nice for a review (after all, how else would I know to write that the heads trace a path 3.037 inches long at an oblique angle of 5 degrees?), but what is needed here is a user's handbook along with the technical manual. Fortunately, Megatape's technical support department was available and very willing to help me make this drive work.

It seems to me that a GT-88, in conjunction with a 6026, may be the ideal set of backup equipment. With the price of used 6026s quickly falling towards \$1,000, you can have 2 GB of backup capacity, along with a 1600 BPI tape for media compatibility, for far less than the cost of a 6250 BPI tape drive. For further information contact:

MegaTape Corporation  
1041 Hamilton Road  
P.O. Box 317  
Duarte, CA 91010-0317

**Odds and Ends Department**

I was having problems using ICOMPACT, the replacement for COLLAPSE that came out with ICobol 1.51, with a particular file, so I decided to log on to OIS and browse through the software announcements. Sure enough, the program has a small bug in it. It tends to corrupt your file with an access error 9B when you do a rewrite to a file with an alternate key that has an odd number of bytes. A replacement module is available.

I saw a story in *PC Week* that Ryan-McFarland has added a SCREEN section in order to be more compatible with DG Cobol. Now, this must be a first—someone trying to be compatible with DG! Sometime soon I'll be taking a look at RM Cobol-85 to see just how compatible it is.

△

*Tim Boyer is EDP Manager at Denman Tire Corporation. He may be reached at P.O. Box 951, Warren, OH 44482, 216/898-2711 or on the NADGUG bulletin board at 415/924-3652.*

# LPI: THE SOURCE FOR STANDARDS IN COMPILERS.



Whatever language you're working in, there's an LPI compiler that can boost your performance in development and execution while meeting all applicable ANSI and industry standards. LPI's unique product line offers a complete environment including an exceptional array of debugging and conversion aids. Our modular, integrated architecture maximizes reliability while enabling you to combine different languages in a single program, then debug them through a common source-level facility. And our exclusive code generator technology protects your application investment by allowing easy migration without conversion. Add LPI's unmatched documentation and CareWare<sup>SM</sup> technical support, and no wonder our products are the standard among America's leading hardware vendors. Call your hardware representative or LPI today for information, ordering, and immediate delivery.

## LPI compilers for Dasher/386 UNIX systems.

**LPI** CALL: (508) 626-0006

Language Processors, Inc., 959 Concord St., Framingham, MA 01701  
Federal Office (301) 595-2558, Telefax (508) 626-2221

The companies mentioned herein own various trademarks.

Circle 42 on reader service card.

# Corporate organization

Summer 1989

**Edson de Castro**  
President & CEO

**Ronald Skates**  
Executive VP &  
Chief Op. Officer

**Corporate Relations**  
James Campbell  
VP

**Legal**  
Jake Frank  
VP

**Sales**  
Herbert Richman  
Exec VP

**Corporate Marketing**  
Stephen P. Baxter  
VP

**Nippon Data General**  
Hisashi Tomino VP,  
Chairman NDG

**Systems Development**  
Tom West  
Senior VP

**Communications Systems**  
Colin Crook  
Senior VP

**Manufacturing**  
Frank Silkman  
Senior VP

**Customer Services**  
Michael Schneider  
Senior VP

**Finance & Administration**  
Michael Evans  
VP & CFO

**N American Sales**  
Angelo Guadagno  
VP

**Software Bus. Unit**  
Joel Schwartz  
VP

**Central Tech. Services**  
Fred Cochrane  
VP

**Telecommunications**  
Vahe Sarkissian  
VP

**Mfg Support**  
Lee Henning  
VP

**US Field Operations**  
OPEN

**Controller**  
Robert McBride

**Americas/Far East**  
Wayne Fitzsimmons  
VP

**Sales Support & Planning**  
Anthony Nicoletti  
VP

**Network Services & Operations**  
John Kavazanjian  
VP

**Treasurer**  
Ellen Richstone  
VP

**European Operations**  
Dave Lyons  
VP & GM

**Tactical Marketing**  
OPEN

**Information Management**  
James Ryan  
VP

**Sales Planning**  
Ray Fortune  
VP

**Human Resources**  
Don Bateman  
VP

Focus will present on a regular basis a chart of the corporate structure at Data General. The current chart shows vacancies in the US field operations and tactical marketing positions created by the resignations of William Bentley and Frank Keaney. Also, Ellen Richstone has been promoted to vice president since the last printing.

# JOIN FORCES

## IN THE FIGHT AGAINST POOR SYSTEM PERFORMANCE!

### INFOS reorganization with the VS.TOOLBOX™

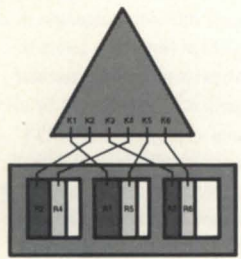

**Before reorganization:** Modifications have made the INFOS file disorganized. As each record is accessed, a different page must be read from disk. A large amount of I/O is required, and INFOS performance is poor.

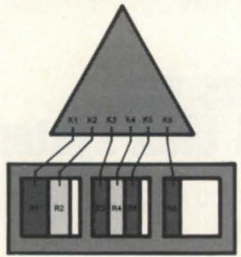

**After the VS.TOOLBOX:** Data records have been re-written sequentially. During sequential processing, each page must be read from disk only once. The amount of I/O is reduced, and INFOS performance is improved.

**PHONE:**  
**(913) 823-7257**

### Disk reorganization with the DISK.PAK™

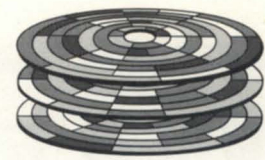

**Before reorganization:** Directory information, frequent files, and available space scattered throughout the disk. High average seek distance and poor performance.



**After the DISK.PAK:** Directory information and frequent files clustered on a few cylinders, available space made contiguous. Low average seek distance and improved performance.

### EAGLE Software, Inc.

P.O. Box 16 / 169 E. Cloud  
Salina, Kansas 67402-0016

VS.TOOLBOX and DISK.PAK are trademarks of EAGLE Software, Inc.

**FAX:**  
**(913) 823-6185**

Circle 33 on reader service card.

# Bits and bytes from the bulletin board

## AOS/VS rev 7.64

From: David Wright

We upgraded our systems to 7.64 recently. I have not found many new and exciting things yet, although I have found some problems. As a new member to this bulletin board, I see that I am not alone. My position requires writing installation procedures for our software, and also tape reproduction macros. I have run up against a little bug in the DUMP\_II.PR that I don't like. When using the /FLAT switch to dump a subdirectory, the subdirectory name is now included in the file. When doing a load back to disk, I get the files correctly, but now I get a CPD or DIR included. Has anyone else seen this and is there a patch or work-around (other than having to DIR into the directory and not use the /FLAT switch)?

From: Kevin Danzig

Had you tried it under prior revs? My understanding is that what you experienced is the correct way the /FLAT switch works.

From: Rob Mougey

DUMP\_II has always loaded the directories when using the /FLAT switch. We started our system on 7.57 and now run 7.64 of AOS/VS.

From: David Wright

We used previous revs for this operation and, prior to 7.64, I did not have a problem getting only the files using the /FLAT switch. We went from 7.60 to 7.64, so I can't comment about 7.62. This started occurring after 7.64 was in place. I have changed all of my macros to compensate for this and do not get the errors when trying to compare the old file listings with the new ones.

From: Bruce Johnson

What you've experienced in getting unwanted directories using the /FLAT

switch is what I've noticed in the three years I've worked with AOS/VS. I was always fussing at our operators about the directories they'd pull in on a restore. That dates back into rev 6 at least. Regarding LOAD\_II, check your macros and be sure your switches are actually being passed through.

## To VS 2 or not to VS 2

From: Tim Boyer

This is bound to cause some discussion . . . . Since I bought my MV/8000 after July '88, I have [a limited time] in which to receive—absolutely free—VS 2. Do I go, or do I stay?

From: Kevin Danzig

Do you need any of the features of VS /II? (Is there some future super disk that you are going to buy with enough space to typeset every telephone directory in the continental U.S.?) Are you happy with what you have? Do you feel a need to buy more memory?

I don't understand your question. Get it and load it, if you must. But keep your systapes for VS/Classic. Considering our past conversations about bargains (does the word Fuji ring a bell?) even if something is free, if it doesn't help or do something for you, its potential costs can outweigh any gain.

From: Tim Boyer

Do I *need* it? Probably not. But then again, I was perfectly happy with RDOS. Some of the features would be nice—eg, mirroring logical disks. My real problem is: do I get it now, or wait (and risk the problem of not being able to afford it when I want it), or wait (until Unix takes over and the whole question becomes moot), or what?

From: Kevin Danzig

Mirroring LDs would be nice. Are you

running a transaction-based environment that needs them or a simple ICobol setup with some on-line data entry and batch jobs (and a bunch of non-interactive jobs run regularly from live consoles)? I am not putting down ICobol or ISAM. In fact, I exploit them (simple INFOS DBAM as well) and try very, very hard not to use DBMS under whatever name you give it, because of corruption. Do you really need VS/II? (I wouldn't mind rev. 8 though!)

From: Bruce Johnson

That's an interesting consideration. I don't know enough about the memory requirements and performance of the two VSs to clearly pick one over the other. If the machine you have is the only DG you are going to work with, then perhaps you ought to go with II. Good luck with your decision—and be vocal about your reasons for the rest of us.

## DX16 terminals

From: Tom Moore

Has anyone had experience with the new DG D216/416/462 terminals yet? I am curious as to the usefulness of having two RS-232 ports and being able to switch between tasks. I used a Sperry-Univac terminal that had a similar feature. Any input would be helpful.

From: Randy Berndt

I have the 462 and the dual port feature is very helpful but, as is usual with DG, they only went half way to completion. If you use the second port as another tube, compressed screens don't work . . . aaaargh! So the 462 is *not* a 461 replacement if you want to use dual ports and compressed at the same time. I think this is an incredibly stupid design mistake. Also, if you ride ctrl-S ctrl-Q to quickly start and stop screen displays (like typing a file and q/s'ing every couple of lines), the 462 gets in some weird race condition and sends out a ctrl-S at about

## HOW CAN UNIX HELP YOU?

With help from Robert Reese & Associates!

Our experience with AOS/VS, RDOS, DG/UX, UNIX, and XENIX can help you port your programs, data, and macros safely and quickly to your choice of platforms.

As an authorized reseller for Data General Corp., The Santa Cruz Operation, and others, we have the background to plan, implement, and assist you in your conversion.

Make the most of your existing investment! Call today to see how you can share the exciting world of open systems.

Robert Reese & Associates, Inc.  
4040 McEwen, Suite 310  
Dallas, Texas 75244  
800/678-2992 214/392-2992  
FAX 214/490-0238  
UNIX, XENIX, AOS/VS, RDOS, & DG/UX  
are trademarks of ATT Corp, Microsoft Corp,  
and Data General Corp.

Circle 74 on reader service card.

- How much memory do I need?
- How many disc drives do I need?
- How many users can I support?
- What's my response time?

:PERFMGR can help you find the answers to these and other questions about your configuration.

Includes a tutorial on AOS & AOS/VS system performance measurement and analysis.

AOS/VS :PERFMGR \$499  
10 DAY TRIAL COPY FREE!

# :SYSMGR

Software for System Managers  
A Division of B.J. Inc.

109 Minna Street, Suite 215  
San Francisco, CA 94105 (415) 550-1454

Circle 62 on reader service card.

## Synergistic Software Company Ltd



Third-Party software products that could improve the efficiency of your computer operations...

- B32 - now on SCO/XENIX as well as AOS/VS
- DiskOpt - even for single disk systems
- EMU/470 - the best value D470 emulation for PCs
- JAM - the best front end for Oracle
- PacerLink - for complete Mac integration
- PC/Remote - for PC integration on async lines
- Screen Demon - add snap to ICOBOL or VS/COBOL
- Text Scout - information retrieval for CEO
- VS-Booster - because VS does not cache data
- WPFile - electronic cabinetry for WordPerfect
- WordPerfect - superlative word processing
- 20/20 - the definitive spreadsheet

Free demo for many of these packages!

Hughenden House  
Main Street  
Collingham  
West Yorkshire  
LS22 5AY

Phone 0937 74637  
(24hr) 0937 73446  
Fax 0937 66903

Circle 59 on reader service card.

WE BUY-SELL & TRADE

### CPU 's/MEMORIES /SOFTWARE :

MV 20000/15000  
MV 2000/4000/8000/10000  
Desktop Model's 10/20/30  
NOVA & Eclipse CPU's & Memories

### DISKS/TAPES:

6239 592MB Disk Subsystem  
6236 354MB Disk Subsystem  
6161 147MB Disk Subsystem  
6122 277MB Disk Subsystem  
6061 192MB Disk Subsystem  
6060 96MB Disk Subsystem  
6161 147MB Disk Subsystem  
6160 73MB Disk Subsystem  
6125 1600BPI Tape Subsystem  
6026 1600/800BPI Tape Subsystem  
6021 800BPI Tape Subsystem

### PRINTERS:

DP300 300 LPM Subsystem  
4215 600 LPM Subsystem  
4034G 300 LPM Subsystem  
PR1250 Rolland Printers

### CRT'S:

6500 D216  
6168 D210  
6246 D-460  
6391 D-214  
6169 D211  
WY60 WYSE

### COMMUNICATIONS:

4368 IAC-16  
4367 IAC-8  
4257 ALM-16  
4255 ALM-8  
4241 ULM-5  
4340 AMI-8

Call for prices on Equipment not Listed  
All Equipment Guaranteed  
For Data General Maintenance.

**COASTAL COMPUTER SERVICES INC.**  
**(206)734-3928**

Circle 6 on reader service card.

the same time you do, then after your ctrl-Q, it sends another ctrl-S after about eight characters. Repeated ctrl-Qs give you the file in eight or so byte chunks. Very aggravating. The only solution is to hard-reset (CMD-ERASE PAGE) the tube. Even with these negatives, I still think the dual port is worth it.

From: Doug Rady

You get the same trouble on the D412. The VT220 emulation leaves a little to be desired regarding keyboard definition. I've got a D412 at home and at work and I like being able to switch into VT220 mode and back on the fly. I don't find the dual port thing useful, due to the loss of compressed video when in dual port mode.

From: Tom Moore

If the term was running one port to the MV, and the other port to a PC (or PC network), would the loss of compressed screen capabilities matter?

From: Randy Berndt

Yes, it would matter, since a 461 uses compressed screens, and the 462 is supposed to work like a 461. I have some wide files that I like to fire up a compressed edit session on. I can read all the text, and not waste I/O painting the screen back and forth.

From: Andy Uzick

We bought 10 D216s about six months ago. We promptly found out that: (a) the NEW LINE key repeats when held depressed—a colossal annoyance—and (b) about 9 out of every 10 bells sent to the terminal were ignored. The former remains to be corrected. They did send us new proms (albeit weeks after they said they would) to fix the bell problem, but they over-corrected. A busy room full of them sounded like a nuclear missile alert. We installed an unofficial FCO—a piece of electrical tape over the bell—which helped somewhat.

On a happier note, our new D462 works fine, but the self-test is slow and the loss of 132-columns when dual-porting is a real pain.

From: David Down

We have a few, and our biggest problem was some of the software doesn't recognize the new terminal type and treats them like D200s. Δ



# The latest products for DG systems

## PC\*I Token Ring expands connection opportunities for DG users

Westboro—Data General expanded its industry-standard networking options with the introduction of PC\*I Token Ring, a set of hardware components that supports IEEE 802.5 access methods. PC\*I Token Ring allows customers using DG's Personal Computer Integration (DG/PC\*I) platform to access IEEE 802.5 Token Ring local area networks.

### PC\*I Token Ring pricing\*

Model	Description	List price
#4630	Intelligent Ring Controller	\$5995
#4634	Professional Ring Controller	\$ 595
#4715	Trunk Access Unit	\$ 650
#4717	Token Ring Copper Repeater Pair	\$2900

\*PC\*I Token Ring is available for shipment 120 days after receipt of order.

DG/PC\*I users now have access to a variety of networking standards including Ethernet, StarLAN, and 802.5 Token Ring.

PC\*I Token Ring is a token-passing method in which a "token" picks up and delivers messages to computers connected along a star-wired network. Features include:

- A 4 MB per second data transfer rate
- A star-shaped ring topology providing

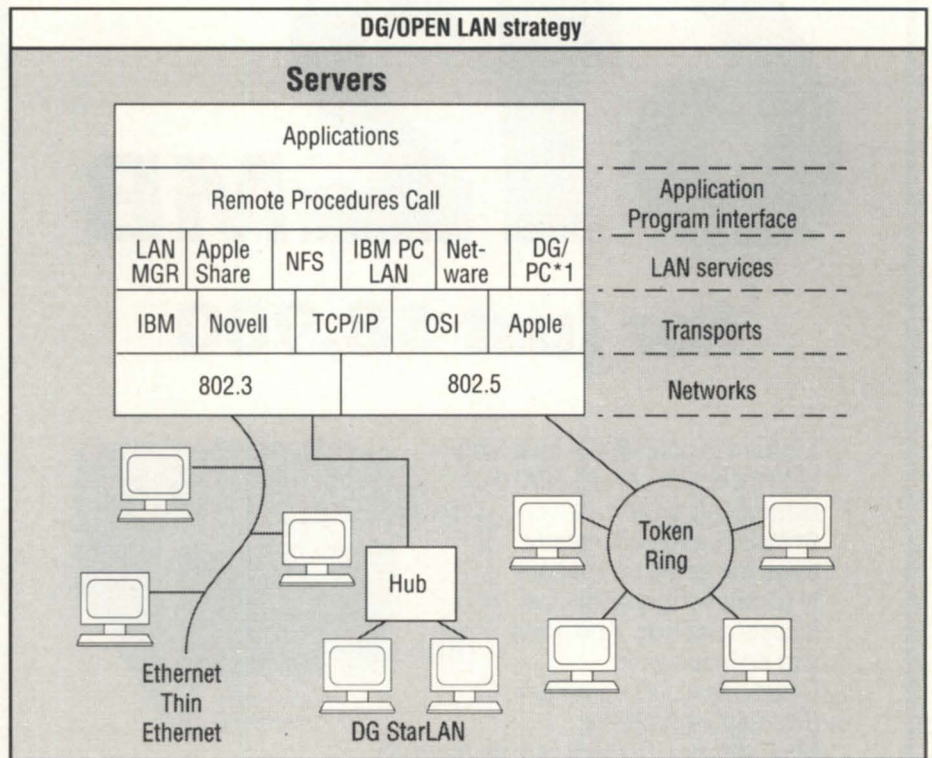

connections for up to eight IBM personal computers

- Support for IBM cabling systems and hardware components including IBM adapters and multi-station access units.

PC&I Token Ring hardware includes:

- A professional ring controller for the Dasher 286, Dasher 386, IBM PC family, and PS/2 models 25 and 30 personal computers
- A trunk access unit that provides PC\*I Token Ring connections for up to eight personal computers
- A Token Ring copper repeater and a fiber repeater to extend network distances.

PC\*I Token Ring supports the Data

General Dasher 286, Dasher 386, IBM PC, PC AT, PC XT, and PS/2 series, as well as the Eclipse MV family of servers.

Data General, 3400 Computer Dr., Westboro, MA 01580; 508/898-4051. Δ

Circle 77 on reader service card.

## DG introduces three mid-range minis

Westboro—Data General demonstrated its commitment to the MV family line of computers with the introduction of the Eclipse MV/15000S series, three mid-range packaged systems that include an integrated floating point unit and pre-configured disk and tape subsystems.

The three packages, Models 8, 10, and 20, support from 16 to 64 MB of memory in 8 MB, 16 MB, and 32 MB increments. Systems can be upgraded by replacing the CPU board. The MV/15000S is configured with a choice of three peripheral packages, including a combined storage subsystem with one 322 MB disk, two 322 MB disks, or a 1 GB disk subsystem, and an auto-loading 1600 BPI tape drive.

The combined storage subsystem supports up to seven mass storage devices in a compact, rack-mounted chassis. It includes system and user disk, tape backup, and interchange media.

Prices for the MV/15000S series start at \$90,700 and include an operating system right-to-use for an unlimited number of users. DG claims the packages offer a price savings of up to 20 percent

over competing systems like the IBM AS/400 systems or the MicroVAX and VAX6300 series.

*Data General, 3400 Computer Dr., Westboro, MA 01580; 508/898-4051.* Δ

Circle 78 on reader service card.

## D:drive allows MVs to drive PCs

Ann Arbor, MI—Digital Dynamics, Inc., announced D:drive, a software product for MV family computers that allows PC files to be stored in the MV via an asynchronous line. The software is transparent to programs and DOS commands.

D:drive gives companies that use PCs and MVs the ability to read and write MS-DOS files on the MV. Storage capacity is over 32 MB per user. A terminal emulation feature allows users the ability to switch between AOS/VS and MS-DOS operation.

*Digital Dynamics, Inc., 3055 Plymouth Rd., Ann Arbor, MI 48105; 313/995-2400.* Δ

Circle 81 on reader service card.

## New CAD software solution aids highway design

Westboro—A new software solution for civil engineers and land developers is being offered by Data General. DG /AROSE (automated road or site engineering) for InfoCAD integrates highway design and terrain modeling with coordinate geometry and geographic information systems.

The product combines the highway design, earthwork capabilities, and terrain modeling enhancements of DG /AROSE with InfoCAD's graphics, applications, and GIS platform. InfoCAD is a product of Digital Matrix Services, Inc., (DMS), a DG value-added reseller.

*Data General, 3400 Computer Dr., Westboro, MA 01580; 508/898-4051.* Δ

Circle 79 on reader service card.

# 612<sub>MB</sub>

## for just \$8,900

It's hard to choose the best feature of Indocomp's new IS-4210 disk storage subsystem. At 612MB, it gives you nearly twice the additional capacity of other subsystems, yet it costs a lot less. And it lets you interface your L-bus-based DG computer (MV/2500, MV/2000, MV/1400, or DS/7500) with as many as 7 peripherals.



The 612MB disk—a Control Data WREN V—is just the beginning. The IS-4210 has a powerful IS-4200 SCSI controller, an AOS/VS-compatible driver, and a sturdy, compact, desktop enclosure. Cable and power supply are included.

The IS-4210 storage subsystem gives you the most capacity for the least money. . . and it's available now. Call Indocomp or your Indocomp distributor today. (Also ask about other products to help you get the most from your DG computer, like the IS-3200 VME adapter, the IS-4100 intelligent I/O controller, and the IND-68000 intelligent I/O frontend.)

### INDOCOMP SYSTEMS, INC.

P.O. Box 157 • Drayton Plains, MI 48020 • (313) 666-9715 • FAX (313) 666-1001.

Circle 37 on reader service card.

## Mainstreet offers full-text DBMS

New York, NY—A new free-form search and retrieval software has been introduced for Data General systems by Mainstreet Software, Inc.

Equipped with a command set for full Boolean and proximity searches, the systems require only a word, or string of words, to retrieve target text or documents within data bases. The system runs on all micro, mini, and mainframe platforms, and provides interactive access in multi-user environments.

Mainstreet Software, Inc., 381 Park Avenue S., New York, NY 10016; 212/779-8398. Δ

Circle 84 on reader service card.

## Eagle SW launches PCOPY\_PAL

Salina, KS—Eagle Software, Inc., released PCOPY\_PAL, a utility that selectively retrieves files from AOS/VS PCOPY tapes. By loading only specified files, the PCOPY\_PAL eliminates the need to find a free disk on which to load the entire PCOPY.

PCOPY\_PAL allows the user to load specific files based on pathname, pathname template, time of creation, time of last modification, time of last access, or file type. It supports many of the same functions as LOAD\_II.

PCOPY\_PAL costs \$850 for the first license, and \$500 per subsequent license. The price includes support and maintenance for the first year after purchase.

Eagle Software, Inc., P.O. Box 16, Salina, KS 67402-0016; 913/823-7257. Δ

Circle 82 on reader service card.

## Applied Computer Solutions brings Sneakernet to DG

Alamogordo, NM—Applied Computer Solutions has announced a suite of programs for personal computers that allows

# SYSGEN DATA Ltd. MARKETING

## Data General COMPUTERS & PERIPHERALS WORLDWIDE

MV10000 8 MB .....	\$25,000	MV 4 & 10 Memory 4 MB .....	\$3,000
MV8000 2 MB .....	2,250	MV 4 & 10 Memory 8 MB .....	4,950
MV4000 2 MB .....	1,750	MV8000 Memory 2 MB .....	750
MV4000 CPU 0 MB .....	1,250	COMM BASE I/O Rev 12 .....	750
MV4000 DC CPU w/4MB .....	4,960	IAC 16 (RS 232) .....	3,750
MV4000 SC CPU 2MB .....	Call	IAC 8 (RS232) .....	1,500
M600 1MB, ALM 16, 6026 .....	1,500	MCP 1w/TCB .....	1,500
Zetaco BMX2 .....	1,800	DG 160 MB Disk .....	2,650
6122 S/S Earthtone S/S .....	750	4433 Printer .....	450
6239 S/S .....	11,250	ISC-2 .....	1,000
120 MB Drive .....	1,200	6026 and cabinet (Earthtone) .....	2,250
6231 Tape Drive S/S .....	500	Exp. Chassis (MV10000) .....	1,750
6311 Tape Drive .....	800	BBU (MV10000) .....	750
LAN Board-MV2000 .....	1,000	4327 B300 .....	1,500
LAN Board-MV10000 .....	2,950	4364 B600 S/S .....	2,500
Sync MV2000 .....	700	D460 ...\$400; D410 ..\$375; D411 .....	400
WIOC (MV10000) .....	4,500	Multitech Modems 2400 Baud New .....	325
MV 4 & 10 Memory 1 MB .....	500	Micom 8 Port MUX .....	950
MV 4 & 10 Memory 2 MB .....	1,100	Micom 4 Port MUX .....	500

**BUY • SELL • TRADE • LEASE**

PRICING SUBJECT TO CHANGE WITHOUT NOTICE  
 QUANTITY DISCOUNTS AVAILABLE ON ALL ITEMS  
 ALL EQUIPMENT SOLD IS WARRANTED FOR 30 DAYS  
**WE ALSO DISTRIBUTE IBM PC, XT, AT, COMPAQ & PERIPHERALS**

12 ELKLAND ROAD, MELVILLE, NY 11747 (516)491-1100 fax: (516)491-1559

Circle 60 on reader service card.

## Virtual Terminal Emulation and File Transfer

VTerm facilitates dial-up sessions to and from any remote system, including file transfer capability. DG to DG communications using complete virtual mode. DG to PC in TTY compatible mode (great for bulletin boards, etc.).

VTerm Features Include:

- TTY Emulation
  - Supports all public networks
  - Pre-programmed script files most popular networks
- Menu-driven CEO® Style User Interface
- Xmodem File Transfer Protocol
- Supports Generation and Use of Script Files
- Context Sensitive Help
- Default Answers for Most Parameters

Price \$495.00

AMR  
 P.O. Box 619616 MD 4360  
 DFW Airport, TX 75261-9616  
 (817) 963-3435



CEO is a registered trademark of Data General

Circle 2 on reader service card.

# AD INDEX

Company	PG#	RS#	Company	PG#	RS#
Ames Sciences, Inc.	58	1	Minitab Statistical Software	75	-
AMR	73	2	NADGUG	14	-
BL Associates, Inc.	1	3	NADGUG	62	-
Catalina Computers, Inc.	59	4	NADGUG Bulletin Board	75	-
Clafin & Clayton, Inc.	22	5	NADGUG Conference 89	50	-
Coastal Computer Services	70	6	NPA Systems Inc.	29	47
Compuplan International, Inc.	36	7	OASIS	52	48
Computek Ltd.	15	8	Oracle Corporation	21	49
Computer Engineering Associates, Inc.	7	9	Rational Data Systems	15	50
Computer Systems Remarketing Corp.	15	10	Rave Computer Association, Inc.	45	51
Computer Wholesalers	64	11	Rhintek Inc.	17	52
Concept Automation, Inc.	25	12	Robert Reese & Associates, Inc.	70	74
Concept Automation, Inc.	24	13	Robson & Deakin Ltd.	26	53
Cybertek Software, Inc.	C2	14	SAS Institute Inc.	10	-
Data Assurance Corporation	28	15	SCIP	6	54
Data Bank Associates, Inc.	58	16	SCIP	32	55
Data General Continuing Products Division	C3	17	Security Computer Sales	37	56
Data General Corporation	13	-	Shalless Software Pty. Ltd.	22	57
Data General Customer Service Division	9	18	Spectra Logic	44	58
Data General Direct	3	19	Synergistic Software Company Ltd.	70	59
Data Plus	30	20	Sysgen Data Ltd.	73	60
DataLynx	51	21	:SYSMGR Bulletin Board	75	-
Dataram Corporation	49	22	:SYSMGR, a division of B.J. Inc.	15	61
Dataram Corporation	49	23	:SYSMGR, a division of B.J. Inc.	70	62
Dataram Corporation	49	24	3CI	16	63
Dataram Corporation	49	25	Threshold, Inc.	33	64
Dataram Corporation	49	26	Threshold, Inc.	26	65
Dataram Corporation	49	27	TLC Systems, Inc.	36	66
Delphi Data	66	28	TLC Systems, Inc.	48	67
Design Data Systems	39	29	Vantage Software, Inc.	25	68
Digital Dynamics Inc.	43	30	Verdugo Computers, Inc.	5	69
DMS Systems, Inc.	23	31	Wild Hare Computer Systems Inc.	60	70
Eagle Software, Inc.	19	32	WordPerfect Corporation	57	71
Eagle Software, Inc.	68	33	Zetaco	C4	72
Fast Track Systems, Inc.	63	34			
Flying Point Software	64	35			
Hanson Data Systems, Inc.	24	36			
Indocomp Systems, Inc.	72	37			
Infodex	22	38			
International Computing Systems	42	39			
Interscience Computer Corporation	18	40			
K & M Computers	48	41			
Language Processors, Inc.	67	42			
MAXON Computer Systems Incorporated	35	43			
MAXON Computer Systems Incorporated	31	44			
MAXON Computer Systems Incorporated	38	45			
McIntyre's Mini-Computer Sales Group Inc.	47	46			
MegaTape Corporation	41	73			

## PRODUCTS AND SERVICES

Company	PG#	RS#
Applied Computer Solutions	73	75
Computer Techniques, Inc.	75	76
Data General	71	77
Data General	71	78
Data General	71	79
Dataram Corporation	75	80
Digital Dynamics, Inc.	72	81
Eagle Software, Inc.	73	82
Interface Electronics, Inc.	75	83
Mainstreet Software, Inc.	72	84

## ON-LINE HELP *Who to call for answers about NADGUG and FOCUS*

### NADGUG's electronic bulletin boards

(300 or 1200 baud modem)

Rational Data Systems .....415/499-7628

OIS (to get an OIS ID and password, contact a DG field engineering telemarketing representative).....800/325-3065

In Massachusetts .....800/952-4300

In Canada .....416/823-7830

### NADGUG membership, address changes

Suzanne Himes.....800/877-4787

(Outside the U.S.) .....512/345-5316

### Information on RIGs or SIGs

Cathlene Gentry .....800/877-4787

(Outside the U.S.) .....512/345-5316

### Editorial questions, comments, article suggestions

Greg Farman or Robin Perry

(please send product announcement to the address listed below).....512/345-5316

### Information about advertising in FOCUS

Sharon Dennis.....512/345-5316

### Back issues of FOCUS

Turnkey Publishing staff.....512/345-5316

### NADGUG staff

c/o Turnkey Publishing Inc.

Stillhouse Canyon Office Park  
4807 Spicewood Springs Road  
Suite 3150

Austin, TX 78759

### FOCUS Magazine

c/o Turnkey Publishing Inc.

Stillhouse Canyon Office Park  
4807 Spicewood Springs Road  
Suite 3150

Austin, TX 78759

transfer of data between Data General machines and PCs.

The Sneakernet portfolio includes:

- SNet—a Data General MS-DOS file utility that initializes RDOS diskettes and makes transfers between DG and MS-DOS formats

- Fixeol—a utility to convert line terminators to MS-DOS, RDOS, or AOS/VS format

- DGDUMP—a utility that puts MS-DOS files into an RDOS dump format file
- DGLoad—a utility that extracts files from an RDOS dump format file and puts them into an MS-DOS environment.

Prices are: SNet, \$100; Fixeol, \$25; DGDUMP, \$45; DGLoad, \$45. The entire suite sells for \$150.

*Applied Computer Solutions, 2336 Union Avenue, Alamogordo, NM 88310; 505/434-0206.* △

Circle 75 on reader service card.

## Interface releases Prism multiplexor

Farmington Hills, MI—Interface Electronics has released Prism, a statistical time division multiplexor for small- to medium-sized (2 to 24 users) communications networks.

Features of the Prism include: ring and alternate routing in case of link failure, static balancing, dynamic balancing, traffic bypassing, and peer-to-peer communications. In the peer-to-peer communication design between multiplexors, the network can be configured either at a remote site or at the host site, without additional programming.

*Interface Electronics, Inc., 37500 Enterprise Court, Farmington Hills, MI 48331; 313/553-9820.* △

Circle 83 on reader service card.

## QUEO\_V 4GL available for DG

Clarks Summit, PA—Computer Techniques, Inc., has announced the availability of the QUEO\_V fourth generation language data base management system on the Data General platform.

QUEO\_V's menu-driven operating system allows users to select modules such as data dictionaries, programs, and screens that are integrated to provide ease of use across a spectrum of applications.

It utilizes a "what you see is what you get" (WYSIWYG) method for creating files, designing screens, and generating reports. The user can design a screen format with field and data information. The QUEO\_V compiler generates a data dictionary, data file, and an entry/query/update file. This allows users to prototype an application.

QUEO\_V runs on AOS/VS, DG/UX and MS-DOS operating systems.

*Computer Techniques, Inc., P.O. Box 257, Clarks Summit, PA 18411; 717/586-1030.* △

Circle 76 on reader service card.

## Memory expansion for MV/7800 series

Princeton, NJ—Users of Data General MV/7800XP, MV/7800DCX, and MV/7800UX machines can now expand to 8 MB, 12 MB, or 14 MB of memory using the new DR-7800X memory board from Dataram.

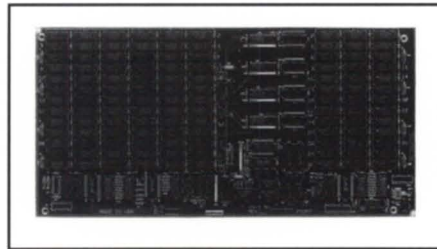

DR-7800X

The DR-7800X memory board is 100 percent compatible with DG hardware and software, so it is ready to plug in and run. List prices are \$4,000 (4 MB), \$8,000 (8 MB), and \$10,000 (10 MB).

Standard with all Dataram memories is the lifetime warranty/express spares program. If anything goes wrong with a Dataram memory board, a spare board will be shipped overnight.

*Dataram Corporation, P.O. Box 7528, Princeton, NJ 08543; 1-800/822-0071 or 609/799-0071 (in New Jersey).* △

Circle 80 on reader service card.

### DIAL-UP BULLETIN BOARD

#### Use the NADGUG BBS!

*No Charge—Simple, on-line registration. Supported by your membership dues.*

300, 1200, 2400, 9600 baud  
24 hrs/day, 7 days/week

**415/499-7628**

Now with multiple lines and downloads!  
Operated by **Rational Data Systems, Inc.**

:SYSMGR BBS specializes in file transfer of RDOS and AOS[VS] DUMP files - no messaging facilities. XMODEM, YMODEM, and KERMIT supported. 415/391-6531 (one line), 1200 baud (Vadic 3447), 8 data bits, 1 start/stop bit or 415/550-1454 (voice). Systems is MV/4000, terminal mode is CHAR/605X.

### SOFTWARE

#### Statistical Software

- Powerful
- Fast
- Easy-to-use
- Inexpensive

**MINITAB**

STATISTICAL SOFTWARE  
3081 Enterprise Dr., State College, PA 16801

**814-238-3280**

Editor seeks intelligent, articulate individual to create stunning, witty prose for established computer publication devoted to users of Data General equipment. Do you enjoy the creative process, sharing your inner thoughts with others, and writing about your passion (as long as it's clean)? Are you my dream writer? Call Tina at 512/345-5316 and knock my socks off!

# FOCUS

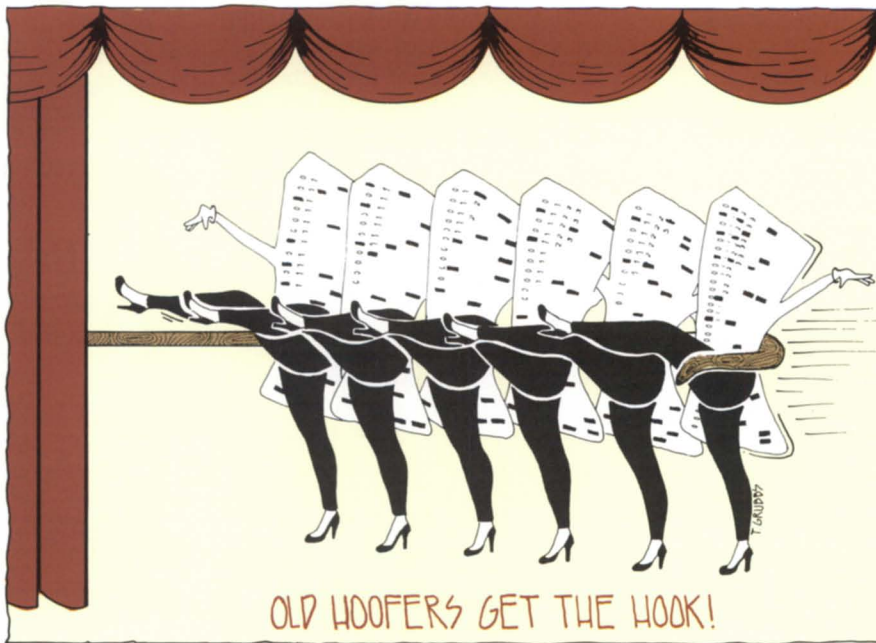

**Zetaco, Inc.**, of Minneapolis, has signed a \$5 million, three-year value-added reseller agreement for Data General's new 88000-based Aviiion systems. Zetaco will also license DG/UX, the company's Unix operating system designed for RISC machines. Zetaco President **Dick Clasen** said a combination of factors influenced the company's decision. These included the speed and multi-processor functionality of DG/UX, aggressive pricing of the Aviiion workstations, and DG's VAR program.

**Bargain-hunting?** *The Wall Street Journal* reports that astute investors are looking for a few companies that have hidden values in their land holdings. Data General, which bought property in California and Boston around 15 years ago, is one such company. The land and buildings are carried on the books at their original cost of \$234 million ("probably grossly understated"), and Data General shares at 17-3/4 are a "bargain," according to **Michael Metz**, market strategist for **Oppenheimer & Co.**

**Dataram Corporation**, a developer, manufacturer, and marketer of computer memory and peripheral products, reported revenues of \$14.4 million for the fiscal year ending April 30. For the fourth quarter ending April 30, the company reported revenues of \$4 million. **Robert V. Tarantino**, president and chief executive officer, cited the rapid growth in the company's DG-compatible products. Dataram introduced four DG add-on memory products during fiscal 1989.

**Data Assurance Corporation (DAC)**, a provider of disaster recovery services to Data General users, has announced the opening of its third hot site. Located in mid-town Manhattan, the facility serves small MV class computers, allowing up to 40 users to perform data entry and administrative duties. Users can also access larger DG computers at DAC's Denver megacenters or Philadelphia hot site. The New York facility was opened under an agreement with **Vantage Software**.

**Fast Track Systems, Inc.**, announced that the **Victims Services Agency (VSA)** has signed a large-scale contract for Fast Track's facilities management services. Under the agreement, the services will be performed at Fast Track's recently completed computer center in Brooklyn, NY. Fast Track will install, operate, and manage the VSA computer system. Fast Track will also provide operations personnel, off-site data storage, hot stand-by systems for protection in the event of computer downtime, and disaster recovery services. VSA manages the witness data base systems for the **New York City District Attorney's Offices**.

**Data General** has signed a value-added reseller agreement with **Environmental Systems Research Institute, Inc. (ESRI)**, a supplier of geographic information systems software. ESRI, a former DG inde-

pendent software vendor, entered the VAR agreement in order to market a turnkey solution consisting of its **ARC/INFO** geographic information systems software running on MV family computer systems.

**Mega Ltd.**, a United Kingdom software and systems house, has appointed **Information Access, Inc. (IAI)** of Cleveland, as U.S. distributor for its Data General-based corporate accounting and management information software. The agreement with IAI represents a considerable expansion of Mega's international operations and makes its **Miracle** suite of software systems available in the U.S. for the first time.

**Policy change!** Data General has officially reversed its policy regarding **SSS** and **Support Plus (SPSA)** services. Users are no longer required to have at least one CPU on Support Plus before they can purchase SSS. (Under SSS a user automatically receives software revisions and upgrades. Support Plus is a higher level of service that includes SSS and technical support from DG's service center in Atlanta.)

**Larry Lapide**, manager of software support services for DG, said the policy revision was based on feedback (including articles in *Focus*) from customers who complained loudly when the "at least one CPU must have Support Plus" policy was announced last October. "Once in a while DG does what is right," Lapide said. "Hopefully, the *Focus* customer base will appreciate the policy revision."

# DIRECT FROM OUR FACTORY TO YOUR BUSINESS.



## MEETING CUSTOMERS' NEEDS AND EXPECTATIONS.

At Data General we uphold the tradition of providing more powerful and cost efficient computers. And our customers have come to expect advancements from us in other areas including operating systems and utilities, data management systems, development tools, communications, office automation systems and applications.

## WE BELIEVE IN BEING DIRECT.

It stands to reason, since we are the original equipment manufacturer, that we are the experts when it comes to refurbishing our Data General equipment. Our quality refurbished products—from CPUs to peripherals—are installed by both large and small customers. We offer you more benefits with each refurbished sale than any other source in the marketplace.

## WE'LL DIRECT YOU TO THE RIGHT EQUIPMENT FOR YOUR NEEDS.

With the help of a Data General sales representative or your Value-Added Reseller (VAR), you may choose from our large product selection ranging from laptop portables up to the large ECLIPSE computers as well as packaged systems, magnetic peripherals, terminals, and communications and terminal interfaces.

## DIRECTLY SPEAKING, WE TAKE "REFURBISHING" AS A SERIOUS BUSINESS.

You can feel assured that there are no risk factors involved when you purchase our refurbished products. Take advantage of these benefits...

- We offer low, competitive prices!
- Our products are refurbished with the latest ECOs relative to software enhancements!
- The warranty is identical to the warranty for our new products!
- We guarantee that each refurbished product has Data General field service certification before it is shipped to you!
- Data General field engineering and maintenance services are available!
- We offer Data General leasing options!

## DIRECT FROM OUR FACTORY TO YOUR BUSINESS.

We have a dedicated marketing staff in our Continuing Products Division (CPD) ready to assist your DGC sales representative or VAR with configuration and pricing information.

Whether you are looking for a packaged system or a stand alone one, CPD marketing will locate the product or, depending upon your company's DP needs, may suggest a better product alternative. So if you are as serious about quality refurbished equipment as we are, then call your local Data General sales office or VAR immediately. They will work with CPD marketing to bring you the best solution... **direct from our factory to your business!**

## TELEPHONE YOUR DATA GENERAL SALES REPRESENTATIVE OR VAR TODAY!

Or write for our free reference catalog on refurbished equipment. Data General Corporation, ATTENTION: Advertising Manager, 2400 Computer Drive. M.S. 1-D, Westboro, MA 01580.

# Data General

Continuing Products Division

(508) 870-1400

© copyright Data General Corporation. 1988.

---

# NEW

---

**SKS-HP Disk Subsystems with  
R.A.M.S.-like performance!**

# FAST

---

80% *more* transactions per second per dollar, drives with 16.5 *ms* average seek time, and 2nd generation SCSI technology make SKS-HP the fastest subsystems around!

# BIG

---

SKS-HP provides 2.6 times *more* megabytes per dollar than R.A.M.S.! Build the system you need, from 654 megabytes up to 4.2 gigabytes!

# SMALL

---

These 5.25" drives need only 3½" vertical space in your rack, and draw only 55 watts per drive.

# EASY

---

SKS-HP Subsystems are plug-and-go compatible with your 32-bit MV computer running under AOS/VS. Call us for a quote on price & delivery.



***For the full story on how you can add a higher-than-R.A.M.S. performance at a lower price, with Data General-compatible, Argus-emulating SKS-HP Disk Subsystems, call us today!***

**(612) 941-9480**

**ZETA-O**

*The Link To Tomorrow.*

*A Subsidiary of the Carlisle Corporation*

6850 Shady Oak Road  
Eden Prairie, Minnesota 55344  
telex 290975, FAX 612-941-1395