

May 1989

FOCUS

The Magazine of the North American Data General Users Group

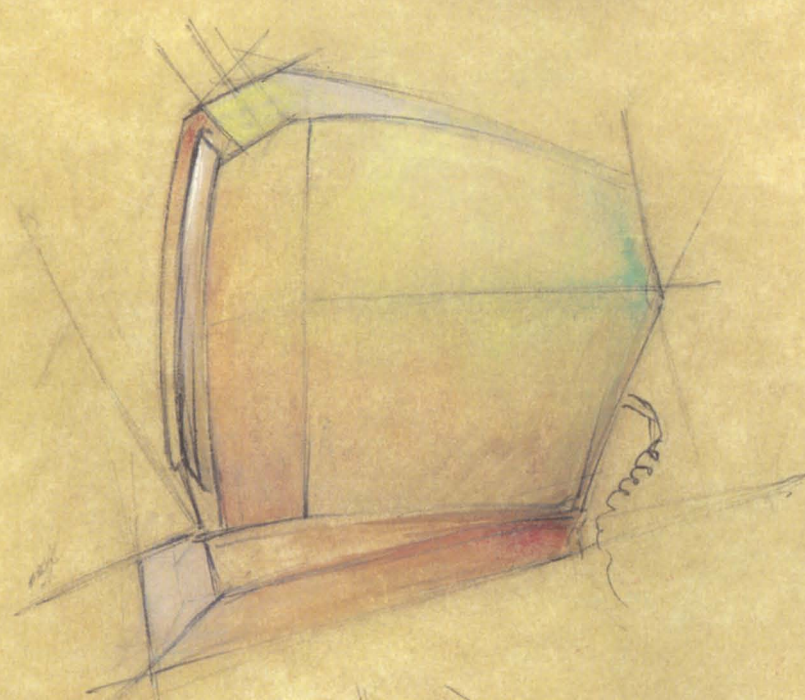
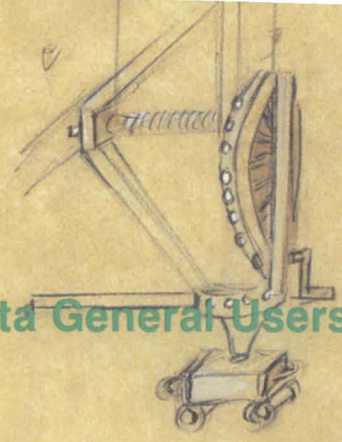

Expert systems

Can genius be duplicated?

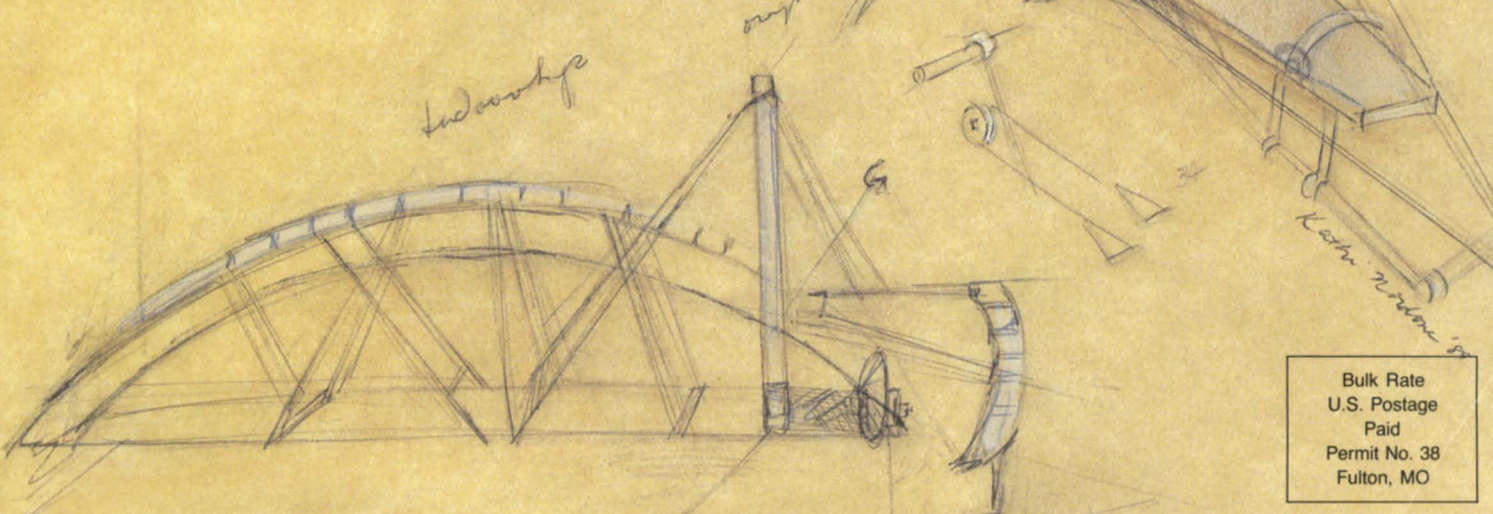

Bulk Rate
U.S. Postage
Paid
Permit No. 38
Fulton, MO

Now, there's no



Your DG MV™ hosts some pretty powerful applications. And your PCs give you convenience you just can't find anywhere else. The problem has been that you couldn't get them to work together. *Really* work together.

Until now, that is. Because now the revolutionary CQCS™ 4GL features true PC concurrency. Complete with DG PCI™ Trendview™ and CEO™ integration.



CQCS gives you a relational view of your database.

Full source code compatibility. And identical implementation on both MVs and PCs.

What's more, CQCS is right at home on the entire DG 32-bit MV/Family, the DG PC Family and all IBM® PC compatibles.

Each PC has access to both INFOS™ and its own database. And meanwhile, your



You don't need any programming knowledge to use the CQCS Report Writer. Automatically generated plots and graphs come with the package.

o competition.



DG screens are supporting PC ergonomics. Like advanced windowing. And full color.

But the real CQCS story is productivity. Because it runs programs like lightning. Much faster than COBOL can. With no increase in machine overhead.

CQCS is fully compatible with existing applications written in any 3GL. Including ICOBOL.™

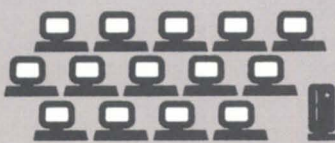

CQCS uses surprisingly little machine overhead. So your MV is free to support more DG and PC terminals.

It's exceptionally easy to use. And once you're installed, you get solid phone and on-line support from DG experts.

So call Cybertek and let us show you what the preferred DG 4GL can do for you. Not to mention your PCs. Because everything works better when we're all working together.

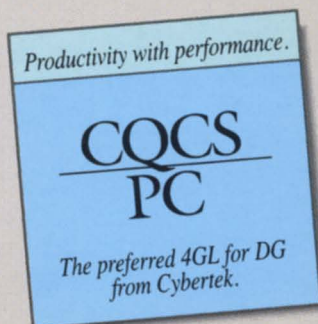

DG
MV
VS.
PC.

PRESIDENT'S PAGE

Spring fancies
by Donald W. Clark

LETTERS

Comments from our readers

ROUNDUP

New Orleans preview
Getting ready for Conference '89;
RIG/SIG committee to offer workshop
by Cathlene Gentry

Uniform reveals DG's commitment
to Unix and industry standards
by John Huddleston

UNIX

The view from San Diego
USENIX conference helped show
DG's place in the Unix picture
by Don Dewar

BULLETIN BOARD

Bits and bytes from the bulletin board

SOFTWARE LIBRARY

A complete listing of the NADGUG
software library

FOCUS ON: EXPERT SYSTEMS

The age of reason
In the world of artificial intelligence,
there are many experts
by Robin Perry

18

FOCUS ON: EXPERT SYSTEMS

Stand and deliver
Expert systems in the U.S. Forest Service

20

FOCUS ON: DESKTOP PUBLISHING

Many faces for CEO
Office/Publisher lets users create
professional-looking documents
by Joe Cannata

2

6

FOCUS ON: DESKTOP PUBLISHING

Wordperfect is the keystone for Focus'
typesetting and pagination system

8

8

OS/2

Testing the waters
New products, new choices, new terminology
confront workstation users
by Brad M. Friedlander

8

8

REVIEW

Office party
New features make Wordperfect's Office
a strong OA contender

12

12

FUND-RAISING

Fine-tuning tradition
MV system helps orchestrate fund-raising
for Carnegie Hall centennial
by Betsy Zullo

14

14

14

14

14

14

14

14

14

14

14

14

14

14

14

14

14

14

14

14

14

14

14

14

14

14

14

14

14

14

14

14

14

14

14

14

14

14

14

14

14

14

14

14

14

14

14

14

14

14

14

14

14

14

14

14

14

14

14

AOS[VS] TRICKS

Don't duplicate. Instantiate!
Good code only needs to appear once
by John A. Grant

50

SYSTEM MANAGER'S LOG

If it ain't broke, don't fix it
Diagnosing SEPAC's priority scheme
by Brian Johnson

52

DISCOVERIES

Short accounts
Small discoveries on a variety of topics
by Jim Siegman

60

OIS

Streamlined
Improved menus eliminate guesswork
for DG's On-line Information Service
by George Tuthill and Linda Strenck

64

OA TODAY

Under Wordperfect's Spell
Spell-check ensures accuracy of documents
—and makes crossword puzzles a breeze
by Guy Pribyl

66

GAMES

Adventures await
The three 'I's of writing computer games
by Larry Morse

68

PRODUCTS AND SERVICES

The latest products for DG systems

71

ON-LINE HELP

Who to call for answers about
NADGUG and Focus

72

PRISM

Brief notes from the DG community

80

REVIEW

File transfer products
You have a choice of speed, ease-of-use, and price
by Tim Boyer

42

THE WORKSTATION

Hot links
Termserver, ITC tame
terminal connection nightmares
by Doug Kaye

44

TERMINAL READS

Time out
Regaining control from the component
between the keyboard and the chair
by Michael Dupras

46

Cover illustration by Kathi-Ellen Nordone

Focus, the Magazine of the North American Data General Users Group (ISSN 0883-8194) is the official monthly publication of the North American Data General Users Group (NADGUG) in cooperation with Turnkey Publishing, Inc.

NADGUG offices are located at Stillhouse Canyon Office Park, 4807 Spicewood Springs Road, Suite 3150, Austin, Texas 78759, phone 512/345-5316.

Postmaster: Send address changes to Subscription Department, Turnkey Publishing, Inc., Stillhouse Canyon Office Park, 4807 Spicewood Springs Road, Suite 3150, Austin, Texas 78759.

Focus Magazine is distributed to members of the North American Data General Users Group.

Membership fees are \$40 per person. A one-year subscription to Focus (12 issues) costs \$36. For all memberships and subscriptions outside North America, add \$50 to defray costs of mailing. For information on NADGUG membership, call 1-800/877-4787. Address all other correspondence to Focus Magazine, c/o Turnkey Publishing, Inc., Stillhouse Canyon Office Park, 4807 Spicewood Springs Road, Suite 3150, Austin, Texas 78759.

NADGUG is an independent association of computer users: it is not affiliated with Data General Corporation, nor does it represent the policies or opinions of Data General Corporation. The views expressed herein are the opinions of the authors, and do not necessarily

represent the policies or opinions of NADGUG or of Turnkey Publishing, Inc.

Advertisements in Focus do not constitute an endorsement of the advertised products by NADGUG or Turnkey Publishing, Inc.

Copyright © 1989 by the North American Data General Users Group. All rights reserved. Reproduction or transmission of contents in whole or in part is prohibited without written permission of the Publisher. The Publisher assumes no responsibility for the care and return of unsolicited materials. Return postage must accompany all material if it is to be returned. In no event shall receipt of unsolicited material subject this magazine to any claim for holding fees or similar charges.



Spring fancies

Spring . . . a time for April showers, May flowers, and youthful fancies lightly turning to thoughts of the 1989 NADGUG annual conference in New Orleans next September 18-21 . . .

Actually, I don't recall my fancies ever turning to thoughts of NADGUG when I was a youth, but that's probably only because NADGUG hadn't been invented yet. I'm sure the current younger generation has rearranged its priorities. Or if not, they should.

The NADGUG annual conference is a subject I feel strongly about, especially in the spring. That's because each spring the NADGUG Executive Board meets to do half a year's worth of business. We always meet in the city that will host our conference the next fall, and planning for the conference is always one of the main topics.

This year's spring board meeting was no exception. We met March 9-10 at the New Orleans Hilton, right next to the Mississippi River. There was a lot of business to discuss—and I'll get back to that shortly—but right now I want to dwell for a few minutes on the conference.

The 1989 Conference will be a new undertaking in many ways. It's the first time we've had to arrange with a convention center to get all the room we need for sessions, exhibits, and other activities. In the past, we've always been able to fit everything we needed into a single hotel. However, each year our conference has gotten bigger, not just in the number of attendees, but also in the number and variety of sessions offered, the types of social events scheduled, and especially in the number of vendors ex-



Phyllis Danieli leads NADGUG members on a tour of the convention center.

hibiting their products.

If you came to Philadelphia for Conference 88, you saw the limit of what we could do with a single hotel. There just wasn't enough space to go around. That will change this year in New Orleans—in a word, the convention center there is *huge*.

The Executive Board was an amusing sight as we toured the convention center. Phyllis Danieli, who is coordinating all of the activities that go into a successful conference, led about 40 of us out the door of the Hilton and across the trolley line to the Riverwalk. We almost lost some of us

FOCUS

The Magazine of the
North American
Data General Users Group

NADGUG LEADERSHIP

President:

Donald W. Clark

Vice President:

Lee Jones

Treasurer:

Frank Perry

Recording Secretary:

Dennis Doyle

Audit Committee:

Jim Siegman

Meetings Committee:

Jan Grossman

Membership Committee:

Bart Bates

Planning Committee:

Joyce Carter

Publications Committee:

Wes Thomas

RIG/SIG Committee:

Charlene Kirian

FOCUS MAGAZINE

Editorial Advisory Board:

David Appel

Tim Boyer

Steve Kern

Steve Kristan

Jim Siegman

Wes Thomas

Editor/Publisher:

Greg Farman, Ph.D.

Associate Publisher:

Sharon Dennis

Associate Editor:

Robin Perry

Contributing Editors:

Tim Boyer

John A. Grant

George Henne

Brian Johnson

Doug Kaye

Charlene Kirian

Jim Siegman

Contributors:

Joe Cannata

Don Dewar

Michael Dupras

Brad M. Friedlander

John Huddleston

Larry Morse

Guy Pribyl

Linda Strenck

George Tuthill

Betsy Zullo

Senior Art Director:

Ann Soto

Art Director:

Pat McMurray

Production Artist:

Tracy Grubbs

Production Assistants:

John Houser

Carolyn Kelly

Business Manager:

Brenda Millet

NADGUG Membership Coordinator:

Suzanne Himes

RIG/SIG Coordinator:

Cathlene Gentry

Administrative Assistant:

Jose F. Dimas

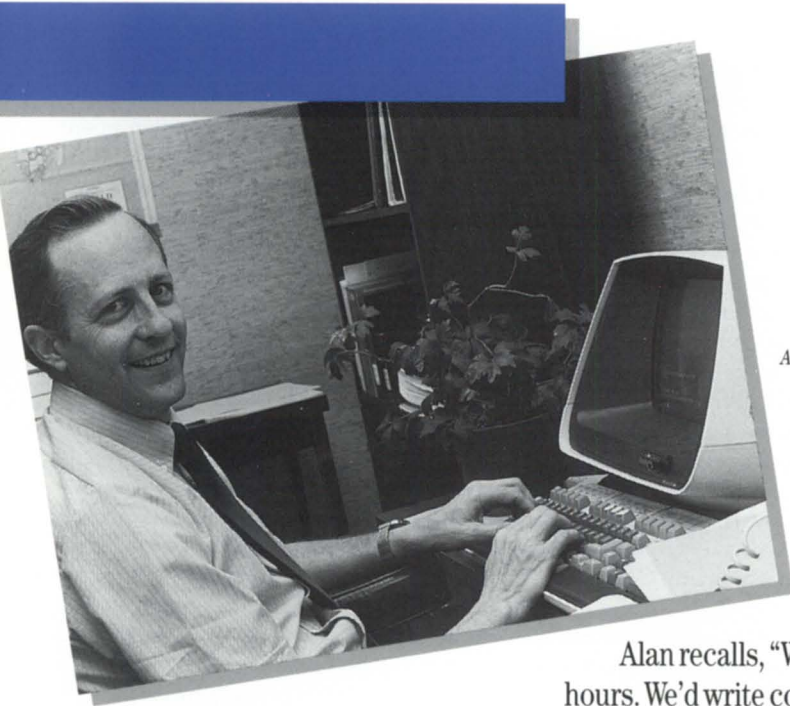

Alan Ashton, in the early days of WordPerfect, working at a Data General terminal.

WordPerfect:[®] It all started on the Data General.

WordPerfect Corporation's relationship with Data General goes back to the very first keystroke.

Alan Ashton and Bruce Bastian had arranged with Orem, a small town in central Utah, to write a word processing program for the city's Data General minicomputer.

Working around the clock in the basement of city hall, Bruce and Alan huddled over a Data General computer. They were developing what would become the new industry standard in word processing. WordPerfect[®].

Alan recalls, "We worked long hours. We'd write code until two or three in the morning, or as long as one of us could stay awake."

And while they developed the program by night, they tested it by day on the city staff. The clean screen, speller interface, and other features are a direct result of listening to what the secretaries wanted.

Under the direction of Bruce Bastian and Alan Ashton, WordPerfect has grown from Satellite Software, a two-man development team, to WordPerfect Corporation, the world leader in word processing.

This pattern of development continues today. With WordPerfect Corporation's support system, users not only receive friendly service, but they are making suggestions that shape the future of WordPerfect products.

Data General, naturally, is one of our strongest platforms. And we continue to listen to DG users. We now work with CEO, and we have developed other tools such as M-Edit, a macro editor, and P-Edit, a program editor. These smaller scale editors tiptoe around heavy DG programs for quicker, lighter editing.

In addition to WordPerfect, WordPerfect Library also originated on the Data General and introduced our electronic mail and calendaring programs.

So from its beginning in the city cellar, to its position as the world leader in word processing, WordPerfect offers you powerful features and the best support in the industry.

"We aimed high from the beginning," Bruce explains, "and we kept our standards high all along."



WordPerfect
CORPORATION

1555 N. Technology Way · Orem, UT 84057
Tel: (801) 222-4100 · Telex: 820618 · FAX: (801) 222-4477

PERFORMANCE @ LOWER COST

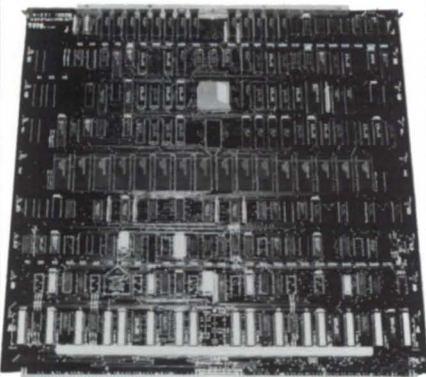

Our **IAX 16** is 100% compatible to the General's IAC 16, but that's where the similarity ends. . . the **IAX 16** offers unmatched response time, convenience and value . . .

- * high speed CMOS based
- * 21% faster/more traffic
- * emulations:

IAC 16=4368/4370

IAC2-16=4368A

- * RS232/RS422 per channel
- * a low 4.1 amps vs. 8.0
- * power up diagnostics
- * correct cabling detect
- * any device code setable
- * runs all DG diagnostics
- * screened on board setup

The **IAX 16**, like our add-in **MEMORY BOARDS**, are performance values because we design them that way. . .

no cloning around.

(213) 282 8700

SCIP

449 So Beverly Dr Ste 201
Beverly Hills, CA 90212

LETTERS

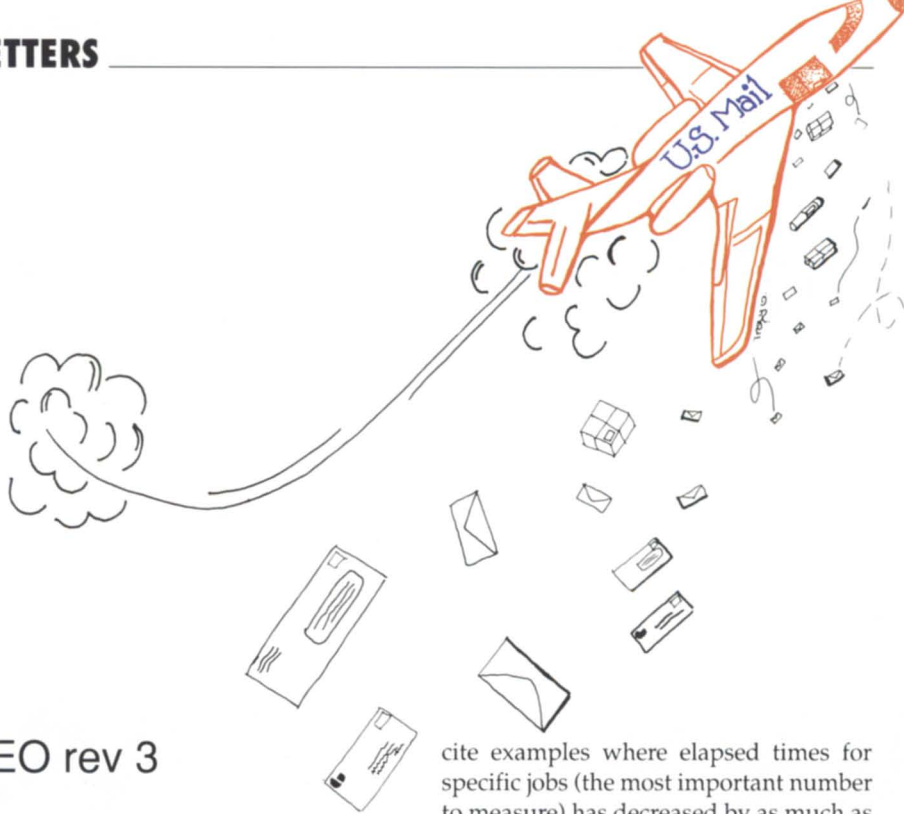

CEO rev 3

We read with interest the paragraph "CEO rev 3 and the host name problem" from ("Does DG value small business?") by Randall Berndt in the February *Focus*.

We are a single CPU site which beta tested CEO rev 3 and it was a disaster. A large number of errors we found were to do with the fact that we only had one CPU. The anguished cry, "Don't these guys think that there are sites with only one CPU?" interspersed with four-letter words was shouted on more than one occasion.

We have a sign fixed to our branch office door, "Data General system software quality control department."

By the way, some errors are still with us 15 months later.

Yours Truly,

Colin Sparrow-Clarke

Director, Systems & Computing Services

Alberta Tourism

Administration Division

Disk optimization

In response to Brian Johnson's dismissal of disk optimization products as "anxiety ware" (Bulletin Board, *Focus*, March 1989) we maintain that the real answer to the question "Does disk optimization improve performance?" continues to be "It depends on the environment!"

To counter his claim of only a 5 percent reduction in disk service time, we could

cite examples where elapsed times for specific jobs (the most important number to measure) has decreased by as much as 50 percent after optimization with the DMS Disk Optimization and Management Utility. The reason we don't publish specific numbers is that there are a large number of variables that impact system performance and the results of specific tests may not be fully applicable in all environments. However, it is very easy for someone to conduct their own test. A system manager can easily obtain a demonstration copy of DiskOpt, then time some of their more common tasks before optimization and after optimization. Is performance better or not?

Brian Johnson used to believe in disk optimization (see *Focus*, February 1987, p. 42). The reason he gave for not expending the effort to eliminate fragmentation is that "you create an artificial environment where disk response time is better than it should be for a few days or a week, and in the process you foster unrealistic expectations on the part of your users." Since DiskOpt is fast enough to run on a daily or weekly basis, this "artificial environment" will cease to be artificial.

We can argue about seek distance, service time, and number of requests per second, but ultimately the only way to see if disk optimization will help a specific system is to try it.

Sincerely,

Sue M. Dintelman

CEO

DMS Systems, Inc.

The shortest distance to a complete installation is a direct line.



When you buy products for your Data General computer you want someone who understands your equipment. Which is why you should call us—DATA GENERAL DIRECT. Because we design and test each product to complement every system, you're assured of the highest quality products.

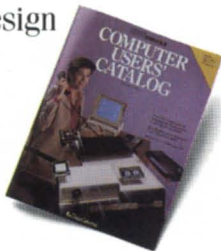

And with our enormous buying power, you get the lowest price.

Hardware. Software. Accessories. Supplies. At DG/DIRECT, we stock every product imaginable for your computer. From unique environmental products to supplies that have been custom designed to fit your Data General equip-



ment perfectly. All backed by a level of support that only our technically trained sales specialists can provide.

For a free copy of our latest DG/DIRECT Catalog, and to be put on our mailing list, call us today. It's the shortest distance between you and a perfect installation.

Data General
4400 Computer Drive MS-1D
Westboro, MA 01580

1800 343-8842
Supplies & Accessories

1800 336-9001
Hardware & Software



New Orleans preview

Getting ready for Conference '89; RIG/SIG committee to offer workshop

A sneak peak at the **New Orleans Hilton and Convention Center** was one of the perks for attending the spring meeting of **NADGUG's** Executive Board March 9-10. After the first day of the meeting, the attendees were given a tour

of the convention facilities that will house **NADGUG's** 1989 Conference. The convention center is impressive and *large*. It was exciting to see how much growth has happened to the conference facilities, **NADGUG's** executive board, and **NADGUG** itself.

At **NADGUG's** spring board meetings each committee gives a report after which all the board members discuss the plans and goals for each committee. This was the first board meeting for the newly formed Membership Committee. **Bart Bates** of **Gibson Petroleum** (403/263-

6300) is the chairperson. He presented several ideas for increasing **NADGUG** membership. Among those being considered are incentive plans aimed at current **NADGUG** members and Data General employees. Other plans include recruiting new members from **RIGs** and **SIGs** and issuing membership cards. All **RIG/SIG** leaders should soon receive **NADGUG** membership applications for distribution. Please help us pass on the benefits of **NADGUG** membership!

The **RIG/SIG Committee** met the morning of Saturday, March 11, to for-

Uniform reveals DG's commitment to Unix and industry standards

by John Huddleston • Special to Focus

Data General wears two hats these days. It supports its proprietary **AOS/VS** operating system, and it also supports a **Unix** operating system. Taking it a step further, Data General's **Unix** supports both the **AT&T Bourne** shell and the **Berkeley C** shell. (This is something that **AT&T** did not implement until its **System V** version 4.0.) Actually, to describe Data General's involvement with the word "support" is an understatement.

While in San Francisco to attend the **Uniform** conference from February 27 through March 2, I learned that Data General is chairing the committee for the development of the **88Open Binary Compatibility Standard (BCS)**. The **BCS** standard will allow executable programs to be transported from one hardware platform to another. That is, developers who write **BCS** software for the new Data General **88K**-based system can be assured that it will run on other **88K**-based machines as well. **AT&T**, with hardware based on the **SPARC** chip, has also joined the **BCS** committee. This benefits software developers by increasing the domain of their applications.

The **BCS** standard also benefits users in a variety of ways. Their investments in software need not be wasted if they decide to change hardware platforms. In general, software costs should be reduced. In addition, **BCS** identifies characteristics for **Motorola**-based **Unix** systems that are important for application portability. The **IBM PC** and its clones are marketed this way—if a program does not work on a particular **IBM PC** clone then that machine is deemed imperfect and rapidly disappears from the marketplace.

Wordperfect Corp. is scheduled to receive an **88K** system in June, and should have its word processing software ready in September of this year. Although **Wordperfect** already runs under **AOS/VS** on Data General **MV** class machines, there are currently no plans to develop this software to run under **DG/UX** on **MV** machines. On the other hand, **MV/UX** runs concurrently with **AOS/VS** so you can have both **Wordperfect** and **Unix** on your **MV**.

Since **Unix** has traditionally been known as a development system, its reputation as an operational system is a well-kept secret. Our **Water Supply Forecast-**

ing group in **Portland** operates under **AOS/VS** and develops all the software under **MV/UX** on an **MV/8000 II**. Our agency made a major purchase of **AT&T 3B2** computers beginning in 1986. These are used in our 2,500 field offices throughout the United States. We anticipate reducing the costs of software development and training in the years ahead.

With the announcement of **88K** systems that do not need special environments or power requirements and yet out-perform **MV/8000s** by a factor of 20 to 1, I am heartened with the news that Data General is taking a lead in the **Unix** industry.

Anyone interested in reading Data General's handout on **BCS** from the **Uniform** conference may obtain a copy from **RIG/SIG** Coordinator **Cathlene Gentry** at *Focus* magazine. Or you may contact your local Data General systems engineer. Δ

John Huddleston is vice president of the NADGUG SIG/UX. He can be reached at P.O. Box 4611, Portland, OR 97208.

THE

Data General SOURCE

- systems
- spare parts
- cables
- upgrades
- exchanges

Call Today!

(818)
246-4915

Buy • Sell • Lease • Extensive Inventory

DATA GENERAL SPECIALS

MV/15000 Mod 8 Upgrade to MV/15000	MV/10000 2MB Memory	\$1,500		
Mod 10	MV/8000 Spare Board Set	1,900		
\$30,000	MV/8000 2MB Memory	1,100		
MV/10000 System 2MB, BBU	32,000	MV/8000 CPU/Chassis Cabinet	900	
MV/4000 SC, Additional I/O Slot, 2MB,	70MB, Cartridge Tape Backup	7,800	MV/1400, 4MB, 70MB Disk, Cartridge	
MV/20000 2nd IOC	8,500	Tape	7,000	
MV/10000 8MB Memory PCB	5,500	6341 Mag Tape Drive (MV/2000)	5,500	

VERDUGO COMPUTERS, INC.

373 West Palmer Avenue / Unit C / Glendale, CA 91204
Phone: (818) 246-4915 / Telex 662758 / FAX: (818) 246-4919

Our DP staff pulled it off



If you want a backup service
that will make you look good,
I recommend

DataSafe
Corporation

Call or send for free information
describing how DataSafe will benefit
you and your company.

Suite 206,
2138 Ashley Phosphate Road,
Charleston, S.C. 29418

(803)553-5847

ROUNDUP

malize plans that had been set in motion during the board meeting. The first order of business was appointing a vice chair to work specifically with special interest groups. The executive board and the RIG/SIG committee recognize that the needs of special interest groups differ dramatically from those of regional interest groups. Therefore it will benefit the special interest groups to have a person who knows about the workings of SIGs and who will be available to offer assistance and guidance. **Bobbie Pressman** was chosen to be the SIG vice chair.

The RIG/SIG Committee will hold its first workshop during Conference '89. The workshop will be held on Monday, September 18. It will be in conjunction with the RIG/SIG luncheon and is open to all RIG/SIG representatives or anyone interested in starting a RIG or SIG. The workshop (including lunch) will last approximately four hours and will offer sessions on utilizing RIG/SIG resources, increasing membership, RIG/SIG accounting, motivational tactics, Data General, monthly meetings and programs, workshops, and producing an effective newsletter. Speakers and program times will be announced in future issues of *Focus*. Please plan on attending and contributing your experiences while learning from others.

NADGUG is seeking volunteers for a speakers bureau for RIGs and SIGs. The talent and expertise among NADGUG members make them the most logical place to start looking for speakers. Speakers will be classified by subject, location, and willingness to speak for free or not.

Steve Kern, eastern vice chair, and **Leryl Cash**, western vice chair, will be in contact with the groups in their areas. If you haven't heard from Steve or Leryl and you need a speaker or wish to be listed in the speakers bureau, call me at 1-800/877-4784.

Four groups petitioned for recognition at the spring board meeting. The newly recognized groups are the **SMBasic SIG**, president, **Ken Smith** (216/621-6425); **Association of CQCS Users**, president, **Ray Walther** (713/626-1919); **Indiana Data General Users Group**, contact,

Nancy Miller (317/253-1711); **Austin Area Data General Users Group**, chairperson, **Mike Leathers** (512/835-0143). If one of these groups interests you, please call the appropriate person listed above.

March was a busy month for most RIGs. Among those meeting were **CARORIG** (Carolinas Regional Interest Group), **Metropolitan New York Data General Users Group**, the **Indiana DG Users Group**, **Association of CQCS Users**, **Central New York DG Users Group**, **WISRIG** (Wisconsin Regional Interest Group), **BUDGE** (Boise Users of Data General Equipment), and **LA EDGE** (Los Angeles End Users of Data General Equipment).

LEDGUG (Law Enforcement Data General User's Group) will hold its Sixth Annual Training Conference in Bellevue, Nebraska on June 4 through June 7. For more information, contact **Al Devitt** at 402/593-2324. (Al says it's purely a coincidence that the meeting dates overlap with the College World Series baseball games to be played in Omaha.)

The Central New York DG Users Group will hold its June meeting in Oswego, New York, where members will be given a tour of the **New York Power Authority** computer operations. For more information, call **Bob Albanese** at 518/438-4571.

Have you had trouble reaching our RIG/SIG committee chairman lately? It may be because she has moved to a new location. **Charlene Kirian** may be reached at **Computer Training Associates**, 1005 BB&T Building, Asheville, NC 28801; 704/251-9551. Δ

Cathlene Gentry is the RIG/SIG coordinator for NADGUG. She may be reached at Focus magazine, 4807 Spicewood Springs Rd., Suite 3150, Austin, TX. 78759; 1-800/877-4787, (1-800/USR-GRUP).

UBB

Universal Business Basic

The unique route to both UNIX & DOS +SQL **now also DEC VMS**

Freedom for BBASIC users

UBB is an advanced new software product that lets you run, support and develop Data General Business BASIC programs in new environments such as Unix, Xenix, MS-DOS, MS-DOS networks – and now DEC VMS. And you can transfer your data files without any conversion. UBB looks and feels just like BBASIC, but is portable and has many extra features and advantages.

Ease of support

Unlike conventional translators, UBB allows *interactive* support in new target environments. So it has the familiar "patch and CONTinue" virtues of BBASIC. It has much more too – like TRACE, WATCH VARIABLE, BREAK etc.

Performance and security

UBB is written in "C" to provide high performance in all target environments and you can choose between three separate levels of run-time security.

Faster development

The development environment under UBB will be familiar to all BBASIC users. No assembler linkers or libraries to delay you. With UBB it is as straightforward as working with

BBASIC, but you also have a range of much more powerful development functions to draw on.

ANSI-standard SQL

And as if that were not enough, UBB also has an associated ANSI-standard Structured Query Language – U/SQL. Capable of combining data from existing BBASIC files (even of differing types), this unique SQL facility enables you to produce custom-designed reports without any programming. U/SQL can also be used on Data General MV machines under AOS/VMS.

Proven software technology

Transoft – the creators of UBB – have more experience than any other organisation in porting BBASIC systems to industry-standard environments. There are now more than 200 Transoft BBASIC sites worldwide.

Prove it for yourself

UBB is available for your in-house evaluation under a special introductory offer. Prove for yourself the benefits of UBB and Transoft's expert product support. Contact Mike Edwards by fax, post or phone to arrange your in-house evaluation.

"I was really surprised UBB worked so easily"

Arnie Sommerville, President
ADS Programming Services,
Decatur, Alabama.

MS-DOS

"Conversion is a snap! We make extensive use of unusual BBASIC commands and UBB's compatibility is unbelievable"

Billy Davis, President
CDS Commercial Data Systems Corp.
Atlanta, Georgia.

MS-DOS

"The performance blows the doors off an MV and Transoft's support has been fantastic – I have never seen better"

Mike Fabrico, Vice President
GKW – Shop MGR Division,
New Jersey.

386 Xenix

"Within 4 days we had our hotel application comprising 350 programs working under UBB – a remarkable achievement"

Herr R. Kurzl, Geschäftsführer
Hogatex Software GmbH,
Munich, Germany.

MS-DOS & 386/ix

TRANSOFT®

Transoft Limited, Shear House, Petersfield Avenue, Slough SL2 5DQ England
Tel 0753 692332 (Int +44 753 692332) Fax 0753 694251 (Int +44 753 694251)

Software Portability & Productivity

Transoft acknowledges all trademarks.

The view from San Diego

USENIX conference helped show DG's place in the Unix picture

by Don Dewar
Special to Focus

DG/UX, Data General's Unix operating system, is a technical success by all industry accounts. Armed with that knowledge and Data General's commitment to a Unix strategy, I attended the Winter '89 USENIX conference held from January 30 to February 3 in San Diego, California.

What is USENIX?

USENIX, which stands for users of Unix, is an association that promotes knowledge and use of Unix. Its purpose is not to sell hardware or software, but to allow Unix users to communicate what they have learned so that the operating system will continue to be used and improved.

USENIX was founded about 12 years ago when a group of people decided to get together and talk about their mutual interest in Unix. That initial meeting has blossomed into an association that holds major conferences twice a year. At these conferences users meet each other to teach Unix-related techniques, especially to novitiates, and to let papers written on Unix-related topics be heard and discussed. Two thousand people attended the winter conference in California.

The format of the conference includes a series of full-day tutorials, paper presentations, and nightly "birds of a feather sessions" (BOFS). A variety of tutorials were held the first two days; for instance, I attended a tutorial on Kerberos, MIT's authentication service for its distributed Unix-based network. Over the next three

days, papers that Unix users had submitted to the USENIX association were presented and discussed. BOFS were held from the second night on for smaller groups interested in discussing a specific topic in an open forum.

Where Data General fits in

In addition to those Data General employees, such as myself, who were sent to the USENIX conference to learn, Data General also did some of the teaching. Michael Kelley, principal software engineer at Research Triangle Park, presented a paper titled "Multiprocessor Aspects of the DG/UX Kernel." This paper discussed all the technical details of a fully symmetric Unix implementation that efficiently coordinates multiprocessor hardware. In his talk, Michael said that DG/UX "does better than most other implementations." He also mentioned that the 88000 port of DG/UX was going very well. His paper and talk were well received, as evidenced by the intriguing questions and interested audience.

At another paper presented by Daniel Klein from Carnegie Mellon University, the 88000 architecture was again mentioned. His paper, "A Comparison of Compiler Utilization of Instruction Set Architectures," compared complex instruction set architectures (CISC) with reduced instruction set architectures (RISC). He set out to prove that CISC architectures are better than RISC architectures, but in the process he proved just the opposite!

Klein's premise is that compilers generate almost all assembly code today, therefore, good architectures should cater to compilers. The 88000 was one of the architectures he used for his data, and it fared comparably to the SPARC and R2000 from this point of view. What he found was that 70 percent of all the instructions on CISC machines are never used by a compiler. In RISC machines, only 30 percent of the instructions went

unused. Klein contends that these unused instructions are frills that the compilers cannot take advantage of and in fact slow the program down. He also found that the programs compiled on RISC machines are not substantially larger than those on CISC machines. He concluded that the future of Unix lies in the RISC arena.

By the way, all the papers presented at the USENIX conference were bound and distributed to conference attendees. If you have further interest in this organization or wish to obtain copies of the conference papers, you may contact the USENIX Association at 2560 9th Street, Suite 215, or P.O. Box 2299, Berkeley, CA 94710. The USENIX phone number is 415/528-8649.

Final views

Before attending the USENIX conference I was skeptical about Unix. I thought it was an ill-conceived operating system with no future. I still think Unix is lacking in many ways when compared to AOS/VS, but Unix has far more ability than I previously believed. Moreover, an operating system that functions in so many environments has to have some constraints. Judging by the number of USENIX attendees, the topics discussed, the number of architectures Unix runs on, and recent work already done on Unix, it is obvious that Unix has a future.

Furthermore, Data General has chosen a wise course for the second fork in its dual-pronged corporate strategy. Unix has a strong presence in the workstation market and an equally strong following of users. The mention of the 88000 architecture in the Klein paper and the mention of the architecture in casual conversation indicates that the 88000 architecture is gaining respectability very quickly.

△

Don Dewar is a software engineer at Data General headquarters. He can be reached at 4400 Computer Drive, Westboro, MA 01580; 508/366-8911.

**IN
CASE OF
EMERGENCY**

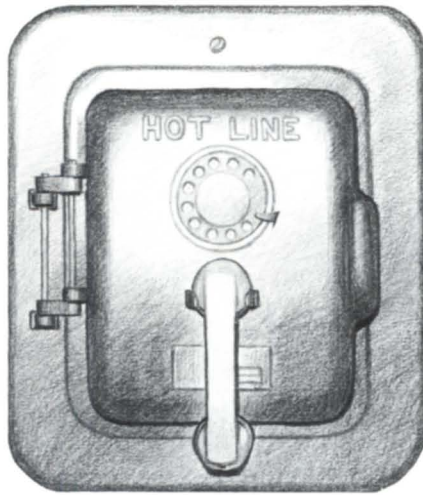

**CALL
FAST TRACK
SYSTEMS, INC.**

FAST TRACK is best equipped to provide disaster recovery services to your company

Look at the facts:

- Multiple hot sites for better geographic coverage
- Fully equipped locations: Manhattan, Brooklyn NY, and Chicago
- Largest base of installed equipment, and most equipment per subscriber of any Data General disaster recovery firm
- Facilities manned 24 hours a day, 7 days a week by trained operators
- Data General VAR authorized to provide disaster recovery services
- The only Data General hot site facility with its own off-site high security data storage vaults offering 24 hour, 7 day a week courier service
- Fully equipped computer room, office space and conference room facilities dedicated to disaster recovery subscribers
- On-site inventory of hundreds of modems, multiplexors, and terminals
- Private communications network available in most major U.S. cities
- In-house Data General communications expertise ready to provide solutions to your networking needs

Before disaster strikes, you need FAST TRACK SYSTEMSSM
(212) 422-9880 (800) 633-3282

Data General has qualified FAST TRACK SYSTEMS as a provider of **DG/hot site** services based on FAST TRACK having met criteria established by Data General.



FAST TRACK SYSTEMS, INC.

61 Broadway New York, NY 10006

FTS is an independent company providing its disaster recovery services for users of Data General equipment.

Circle 29 on reader service card.

Bits and bytes from the bulletin board

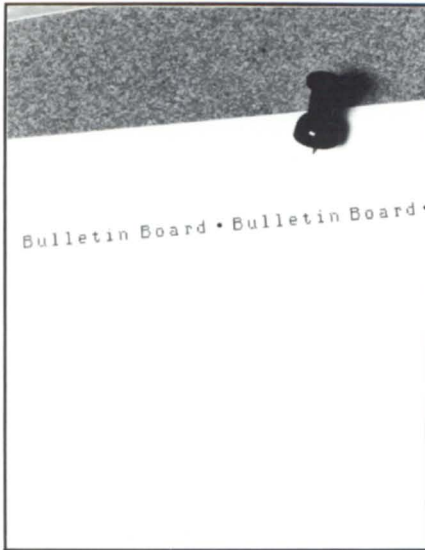

CEO 3.02

From: Rob Mougey

We have been running CEO 3.02 for about six weeks. The problems we have experienced all pertain to the Calendar. If your users rely heavily on their calendars, they will discover problems in re-scheduling meetings. We run an MV/15 standalone. To date, I have applied 14 3.02 patches and reapplied two 3.01 patches (for 3.01 and 3.02). Overall 3.02 is a great improvement over 3.00 or 3.01. There are several undocumented changes that my users noticed before I did. Funny how they have a way of doing that.

From: Tom Moore

Have a seat! I just finished up-revving 2.26 to 3.02. If you plan on going directly to 3.00, don't. Load the 3.00 release, then follow the notice for loading 3.02+. If you use form files, be careful. CEO 3.00 overwrites some of the files in :util:forms. Follow the rev notice carefully.

From: Chris Langford

We are also about to upgrade to 3.02 from 2.26. I'm a bit concerned about the conversion of printer definitions. After a test conversion on one system, I found that printer margins on letter quality printers were set to zero. Did you have this problem?

From: Tom Moore

Yes, but not just on letter quality print-

ers. The new rev replaced my LPT.DEF.FORM and LDP.DEF.FORM. Also, on laser printers, CEO will try to print 8.5-by-10.5 inches on 8.5-by-11-inch paper. Not in this life! Use a magnifying glass or whatever and comb the pages of the release notice about 500 times (and take notes).

By the way, if anyone is using LPT.DEF.FORM for a 132 CPL printer, you will have to run FCU and change the CPL to 132, instead of 80 (in the new rev). If I am not making as much sense as I usually might, I am still all revved out!

MV/40000

From: Mike Shumway

Well, here we go again trying to stay a generation ahead. We are about to put in an order for an MV/40000 model 3 to upgrade our large CEO shop. Does anyone have a 40K yet that they are willing to talk about? Our concerns are obviously rev 8, oops, AOS/VS II, CEO on large systems (what happens to an index with over 300 users on it?), as well as hardware questions. DG is itching to get us to order one (even though the model 3 and 4 aren't available yet) and we would like to be as wide-eyed as possible going into it. Hopefully someone has had some hands-on experience. Thanks.

From: Doug Rady

World Computer in Auburn Hills, Michigan has had several in. They get them in, test them, load them with software, and ship them to customers. They had some hardware problems for a while but that seemed to be a lack of FE education and a lack of local parts. Other than that I think they are happy with them.

PED-iatrists

From: Andy Uzick

PED seems to dislike 6053 terminals. Whenever it attempts to write to a particular line (line 9, I believe), the display gets trashed. Is there some exotic CHARACTERISTICS setting to overcome this or is it a permanent impEDiment?

From: Kevin Danzig

We have had the same problem. If the con line has NAS on (it shouldn't for a 605X), turn it off and see if it works.

7.64

From: Rob Mougey

I would like to hear from anyone that

has successfully loaded 7.64. We are running an MV/15 model 8 at 7.60 and CEO 3.02 (standalone). I would like to take advantage of the new /AUTOBAUD switch for IACs. Does this really work? I am also concerned about the change in XLPT. We have nine DG 6454 (HP Laserjet II) and two QMS Lasers. Any insight would be greatly appreciated.

From: Tim Boyer

I don't know about the /AUTOBAUD switch—I'll have to try it out. XLPT seems to be working well. Compared to 7.62, it's working *incredibly* well. BJ recommends that you change your printer priority to 4 when you go to 7.62. Other than that, it's running like a charm.

From: Brian Johnson

Put data channel printer XLPT priority at SWAPPABLE 1, put buffered printer XLPTs at SWAPPABLE 2 (e.g., lasers). If using 7.62 or 7.64 XLPT (one XLPT—many printers) try SWAPPABLE 1 first. If it causes response time problems, drop it to SWAPPABLE 2 and learn to live with jerky output on data channel printers.

Clean up files

From: Wendell Putney

I just discovered a new "feature" in XLPT. Effective with 7.64, XLPT won't output a cleanup file to a queue you've enabled for BINARY unless the QPRINT is done with the /BINARY switch. I use cleanup files to set character and line spacing and enable NLQ on my Okidatas. How am I to tell my package software that it's supposed to use the /BINARY switch when printing to a binary queue? Neat feature, huh?

AT&T network and Laserjet

From: David Czech

We have an AT&T network running with Data General, Digital, and Wang computers. We are trying to hook a Laserjet II printer to the Data General through the network and we can not make it work. Does any one know how to make an AT&T network and a Data General and Laserjet series II work together?

From: Rob Mougey

We are running AT&T's ISN and System 75. Our DG 6454 (Laserjet II) printers are run through fiber concentrators to the ISN and then to an IAC 16 on the DG. Define your DG port on the ISN as an

EMULATION

IS SOMETHING MISSING FROM YOUR DG TERMINAL EMULATOR?

Introducing EXACT DG Terminal Emulation

@Con/PC and @Con/PC Plus do it all. They are the first programs to allow your PC to emulate all the features and functions of DG terminals (D210 through D411).

@Con/PC, only \$95.

Blazingly FAST File Transfers, Too

@Con/PC Plus uses ConX, its own file transfer protocol, to move files between PCs and Data General MV/series minicomputers. ConX is up to ten times faster than competing products, leaving XMODEM & DG/Blast in the dust! XMODEM and ASCII file transfers are also supported for added flexibility. And, the ConX protocol is available separately for rapid file transfer between MVs.

@Con/PC Plus, only \$149.

Distributor inquiries welcome. Special bundling license available to VARs.

Need XMODEM on Your MV?

Flying Point Software's XM Server is an easy-to-use implementation of the XMODEM file transfer protocol for all DG MV/series minicomputers. XM Server, only \$195.

132-column compressed screens

D411 emulation

True underlining on EGA and VGA monitors

Realistic emulation of all character attributes

Baud rates to 38,400

Programmable margins and windows

Reverse scrolling

Alternate character sets

Selective erasing

15 function keys on the standard PC keyboard

Support for Dasher/286 enhanced keyboard

Mouse support

120-Command macro language

Memory resident mode



(516) 283-4994

Please send me an @Con/PC Plus demo disk. Enclosed is \$10, which will be credited towards the full purchase price of @Con/PC or @Con/PC Plus. Mail to: Flying Point Software, 33 Flying Point Road, Southampton, NY 11968.

Name _____ Phone (____) _____

Company _____

Address _____

City _____ State _____ Zip _____

IMPORTANT: Media type: 5-1/4" _____ 3-1/2" _____

@Con/PC Plus Demo Disk Offer

EIAHOST and the printer port as a terminal on the ISN and then connect the two using a permanent circuit (CN PC address1 address2). We discovered that we needed IAC 8s (with ?mod and ?mri on) to have the DG disconnect if the user did not log off properly. Otherwise the next person to call the hunt group would end up with the other's active session!

AOS/VS II

From: Thomas Carey

An update on AOS/VS II. We had been running it for a week before we took it down this morning. At VSGEN time we took most of the defaults and have just one LDU/physical disk. But our master disk is stretching the limit at around 90 percent full. Given that, the system is considerably slower than 7.62. Also, found by chance that the output from the ?GUNM syscall contains an error. AC0, at least in our test, returned a -1 (should be a 0 or 1).

Most serious though is INFOS. We can read our data bases all day and if we try

to write to them, the write is OK (i.e., no error return); but when that program finishes, the data base is locked out from further use. We get runtime error 3697. Tried everything I can think of but no success so far to avoid that error.

New CLI command

From: Michael Travis

Here's another bit of useless, obscure information. You can't define a macro with the same name as a CLI command, because the CLI checks its internal list of commands before it looks for a macro. The one exception to this rule is . . . XYZZY.

From: Doug Rady

Another of its glaring weak points! It should have the option to look in a system-wide macro directory first, then in the user's searchlist, and then in its internal table. Would add much flexibility!

From: Michael Meissner

If you are real handy with FED, you

can always patch the CLI's command tables to rename commands. I've seen April Fools Days where people change the "BYE" command to "BUY", etc.

AOS/VS to Unix

From: Sharron King

As users of AOS/VS on an MV/10000, we are investigating converting to DG/UX rather than AOS/VS II. If anyone has gone from AOS/VS to DG/UX, it would be very interesting and helpful to hear about the experience. We are basically a Fortran scientific computing operation.

From: Glenn Diehl

We converted from VS on a MV/8000II to DG/UX 3.11 last January. At first, performance was a problem, but it has been improved somewhat with later releases (we are currently running 4.01). Rev 4.02 will be installed soon and it promises more performance improvements. I am pleased with the software for the most part, but the system is not a screamer. Δ

THE KEYS TO THE FUTURE...

... Total DATA GENERAL Systems Support
From the Desktop Generation to the MV/20000

An Authorized DATA GENERAL OEM

For More Information call Jennifer Ryu at: **301-247-5244**

COMPUTER ENGINEERING ASSOCIATES, INC.

Offices in Baltimore, MD • Cambridge, MD • Washington, DC • Pittsburgh, PA • Denver, CO • Moorestown, NJ

SUPPORT SERVICES AVAILABLE NATIONWIDE

Circle 11 on reader service card.

"The Data General difference: customization, not generalization."

Donald Carter, Chairman and CEO
The Carter Organization

The Carter Organization's unique business required unique solutions.

The Carter Organization, the world's largest proxy solicitation and investor relations firm, represents numerous prestigious clients in struggles for corporate control, annual meeting support and corporate governance consulting.

The unusual, time-sensitive nature of this business requires instant access to a variety of data, to sort, review and analyze information efficiently, insure reporting accuracy and streamline communications throughout the organization.

In proxy solicitations, for example, it's vital to keep on top of every phase of the process, including tracking and tabulating votes—literally up to the last minute.

So, when Carter looked to replace their existing computer system, Data General was the vendor of choice. The main reason was Data General's ability to address their specific needs for a custom solution to serve their clients. And keep them ahead of their competition.

Donald Carter, Chairman and CEO, explains:

"In our business, knowledge really is power. The communication of up-to-the-minute information is essential. And reliable technology is key. That's where Data General's custom capabilities proved invaluable. In every respect, they were much more responsive to our unique needs than the competition. Data General offered a more cost-effective, efficient and serviceable solution. They worked with us to provide a unique configuration of hardware and even wrote much of our software."

To learn how Data General can make a difference for you, send the coupon below. Or call: 1-800-DATAGEN. In Canada, call 416-823-7830.



3400 Computer Drive, Dept. ADV/CO, Westboro, MA 01580

Name _____
Company _____
Address _____ Phone _____
City _____ State _____ Zip _____

CALL 1-800-DATAGEN

The age of reason

In the world of artificial intelligence, there are many experts

by Robin Perry • Focus staff

The term artificial intelligence brings to mind images of humanoid computers, pulsing cerebrums with glowing eye sockets, and robots gone mad. But artificial intelligence, far from being part of some sinister future or the screenplay of a science fiction movie, is already here. And it's friendly, dear user.

Here are just a few of the ways artificial intelligence is used today:

- to determine the hotness of chili peppers at a picante sauce factory;
- to schedule airline and hotel reservations;
- to recognize the locations of ships at sea;
- to scientifically evaluate the colors produced at a New England dye factory.

User interface is another area that has witnessed the effect of artificial intelligence. Object-oriented systems like the Macintosh where icons are used to represent various functions are an outgrowth of artificial intelligence. Even the familiar Lotus 1-2-3 is a product of artificial intelligence.

"Any company can take advantage of artificial intelligence. Artificial intelligence is pervasive today, only we don't call it as such," said Stevan Petrofsky, manager for Data General's Artificial Intelligence Marketing Group.

"Artificial intelligence brings together a lot of interesting technologies. The general benefits are in productivity. Decision-supported systems basically help novices get better at what they're doing. They behave as if an expert is sitting over your shoulder and telling you how to do a good job," Petrofsky said.

Expert, or knowledge-based, systems

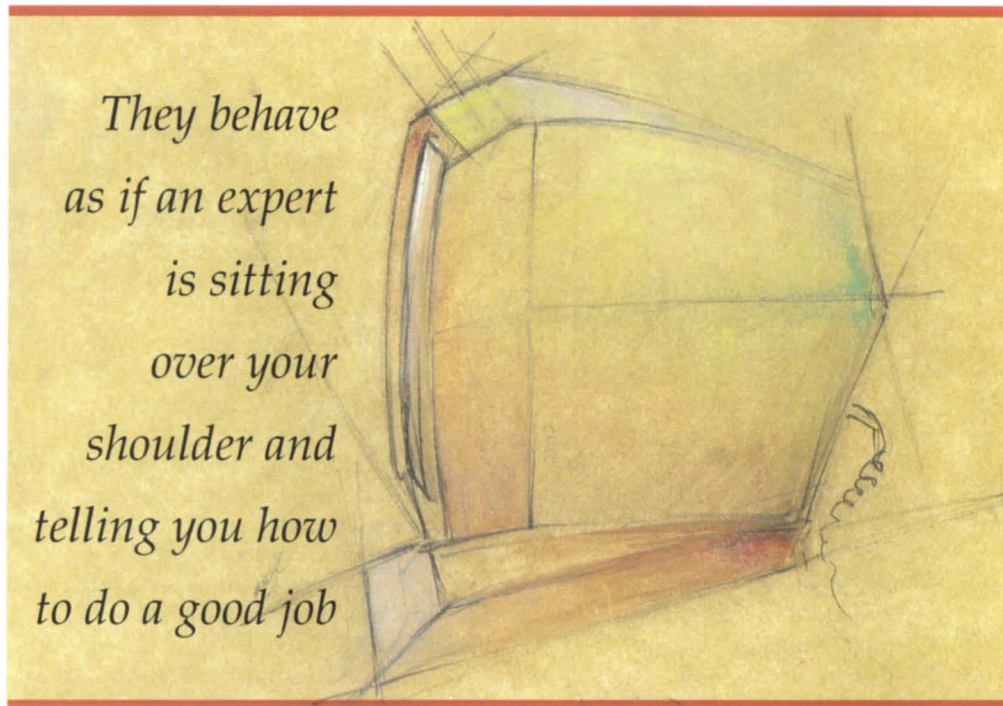

are terms used to describe forms of artificial intelligence that reproduce a person's reasoning logic. In a commercial setting, this often translates to the embodiment of the skill of an expert or master craftsman. These systems represent the fastest growing and most mature application area within artificial intelligence.

Of the expert systems sold in 1988, over half (54 percent) were bought by MIS corporate or department managers. The other expert systems buyers were in the fields of corporate research (14 percent), education (15 percent), and military and other government (17 percent), according to *Expert Systems Strategies Market Review*, published this spring by Cutter In-

formation Group. The review predicts use of expert systems will increase dramatically in the 1990s, especially in the area of commercial applications.

Goldworks

Data General's entry into the expert systems market is in the form of a joint agreement with Gold Hill Computers, Inc., of Cambridge, Massachusetts. Under the five-year commitment signed in 1987, DG and Gold Hill will jointly develop and market a Common LISP-based expert tool, Goldworks, that will run on a range of Data General systems—first on PCs, then on minicomputers, a PC workstation, or all three in a networked envi-

A complete listing of the NADGUG software library

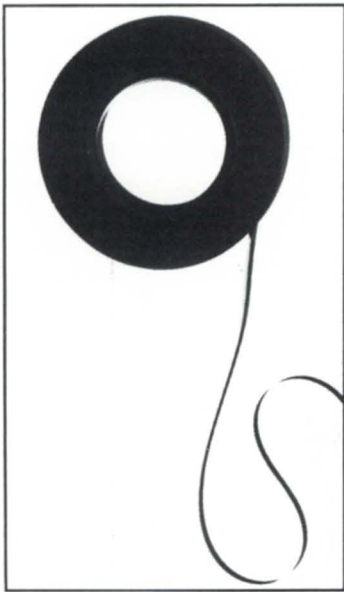

All NADGUG members interested in receiving the NADGUG software collection should send a 1,200-foot tape to:

Randy Berndt
American Urological Association
6750 West Loop South, #900
Bellaire, Texas 77401

or call 713/665-7500. (MV/2000 and MV/1400 users should send one tape cartridge.) Software contributions should be sent to the same address. Be sure to include your membership number.

People with AOS/VS rev 6 should send a 2,400-foot tape and specifically request a DUMP_II instead of the usual compressed version. The decompression program is rev 7-specific.

Please include a self-addressed envelope with sufficient return postage. In compliance with postal regulations, do not date the postage, because the tape will not be returned to you on that date. If you send it at the end of the month, please have the postage read for the following month.

Big Brother

Automatic log-off program written in Fortran 77. Donated by the U.S. Forest Service. 181 blocks.

B.J.'s BBS contributions

This addition to the library consists of about 20 items, including various programs, documentation, and macros. Some of the more interesting items include the :SYSMGR benchmark suite, a continuous incremental backup, a clean-up file maintenance program, a program to find strings in files, and a type-backward program. 5,749 blocks.

CRTEDIT

This is the old RDOscreen editor ported over to VS. 51 blocks.

DBCHECK

This program checks the open status of an INFOS file and examines the check-pointing status of a file. 230 blocks.

DUMpload

DUMpload is a Macintosh program to dump and load AOS/VS-compatible dumps on a Macintosh. 140 blocks.

ERP

A process-termination program developed by NASA and modified by Manville. In Fortran 77. 338 blocks.

FILEMNGR

With this new version, you can move, copy, delete, view, and perform several other options faster. This is distributed as shareware. If you try it and continue to use it, you are requested to pay a registration fee. From Kim Geiger. 459 blocks.

FTNCVT

This is a Fortran 5 to Fortran 77 translator. 287 blocks.

Games

Games is a collection from various places. Enjoy. 19,293 blocks.

Glossary

Glossary is a program from John Grant that builds a list of words used in a document and shows where they are used. 416 blocks.

IMSLUTIL

This is a collection of CLI macros, COBOL routines, and assembly routines callable from COBOL. By IMSL of Houston. 6,154 blocks.

JAG_UTIL

JAG_UTIL consists of several programs: Filecount, Userspace, Scan, and Laminate. 1,501 blocks.

Kermit

Kermit is a file-transfer protocol developed at Columbia University. Uses 9,328 blocks.

Logout

Another auto log-out system. 246 blocks.

Look

Look is used to view text files. It allows you to move forward and backward in a file. This program was donated by Data General. 438 blocks.

Macbook

This is a collection of macros from the Colorado users group. 342 blocks.

MENUDIR

This is an initial user menu that can chain to other applications. It features a password-control system. From the Fed SIG. 492 blocks.

Misc Kerm

An expanded version of AOS Kerm, this now includes other versions of Kermit including DG/One Kermit. 6,298 blocks.

QHelp

QHelp is a tree-structured help facility. 2,277 blocks.

SKLSCRN

This is the COBOL standard entry screen featured in George Burns' article that appeared in the April 1988 issue of *Focus*. 385 blocks.

Softrams

This is a file-transfer protocol written in Fortran 77. It's used to communicate with proprietary PC communications packages. 496 blocks.

SWITCHES

SWITCHES is the GET.SWITCHES routine from John Grant's column in *Focus*. 1,297 blocks.

TEX 2.25

TEX (Terminal Emulator with Xmodem) is a terminal-emulation program written by David Down. He has recently revised the TEX software to include a command language. TEX is being distributed as shareware. At the end of 30 days, either remove it from your system or send the author a \$45 fee. 495 blocks.

VT100KER

VT100KER is the VT100 emulator from John Grant. 1,135 blocks.

Xfer

Xfer is a tape-conversion utility. 653 blocks. Δ

Stand and deliver

Expert systems in the U.S. Forest Service

Flathead National Forest, located in a remote area of northwestern Montana, is the unlikely site of an experiment with one of computer science's most exotic

technologies.

Entering its third year in development is an expert system that will be used to identify and diagnose treatment alterna-

tives for various plant communities. Currently these needs are identified by highly-trained silviculturists, who study a plant population (called a stand) and give treatment alternatives based on many factors including size, location, plant types, and the U.S. Forest Service's management goals, which could include recreation, preserving wildlife, maintaining fisheries, harvesting timber, or grazing.

"Our needs are ones one would classically associate with why you want to develop an expert system," said Jim Reid, director of management information services. "We have a limited number of silviculturist in the field, so there's always a shortage of experts to apply the knowledge. And there's always an increasing demand to work with a larger number of stands than is practical for a silviculturist to do in a given time frame." In addition to speeding up the diagnostic process, the system will help silviculturist make better informed decisions by sorting through volumes of information and seeking out the facts relevant to a specific site, he said.

There are plans to implement the system in all of Region 1, which includes 13 national forests in Northern Idaho, Montana, and North Dakota—in other words, 19 million acres of forested land where stands need to be diagnosed. A stand can be anywhere from 5 to 100 acres in size.

The system, now in prototype stage, is being developed for use on the network of Data General MVs installed throughout the Forest Service. It was developed mainly in-house, with some help from consultants at Data General's Research Triangle Park, said Jim Chew, timber management silviculturist.

"The first year-and-a-half was spent in just trying to develop an understanding of artificial intelligence, in particular expert systems, and getting to the point where we had the software to work on the MV. We didn't want to spend a lot of time working on software on PCs when they weren't going to be the delivery vehicle," he said. "Once we had access to Goldworks we spent a six month period learning the software and developing a prototype. From there it took us about a year to have what I consider a working expert system on our Data General."

Another challenge was preparing the large data base from which the computer will draw information to make recom-

NEW BUSINESS BASIC CONVERSION TO MS-DOS

Alloy Business BASIC (ABB) is an easy to use and comprehensive tool to convert your DG Business BASIC and Bluebird Business BASIC programs to a true MS-DOS format.

Now available to end users and corporate accounts.

ABB lets you take advantage of the growing PC and MS-DOS market by porting your applications to PC hardware platforms and to the universally accepted MS-DOS format.

Download and convert Business BASIC programs to run on your DOS compatible PCs. Whether your needs are for single-user, multi-user or networked PCs, ABB is the solution.

To order please call us at **1-800-432-4356** or 615-370-0037. Visa, MasterCard, COD or approved P.O.s accepted.

ABB Compiler pricing: **\$1,995***

Single-user, Multi-user or Networked, (2nd Quarter '89)

*Additional Site Licenses Extra



Systems Division
100 Winners Circle, Suite 450
Brentwood, Tennessee 37027

Alloy Business BASIC and 386/MultiWare are the registered trademarks of Alloy Computer Products, Inc. DG Business BASIC is the registered trademark of Data General Corporation. Bluebird Business BASIC is the registered trademark of Bluebird Systems. MS-DOS is the registered trademark of Microsoft Corporation.

© Alloy Computer Products, Inc. 1988

Circle 1 on reader service card.

ronment. LISP (List processing) is a symbolic processing language.

The first announcement from the Gold Hill alliance was Golden Connection for the PC and enhancements to DG/Common LISP on the MV family of computers. These two products provided a Common LISP platform over which an expert system application running on the PC could directly access all AOS/VS operating system services and files. Also included was Goldworks' ability to access Lotus 1-2-3 and dBase files and interface with PC-based C language programs.

The second major announcement was in August of last year. The Goldworks inference engine and integrated GMACS editor were ported to the MV family under DG/Common LISP, an integration toolkit was added to facilitate reporting the results of MV interfacing, and a CEO interface was added to DG/Common LISP. Now expert systems can be developed on the PC and delivered on the MV. With CEO integration, expert systems can directly send messages or documents to/

from the electronic mail and filing system. The Lotus 1-2-3 and dBase interfaces are also included for Goldworks on the MV so that with PC*I these files can be accessed from either the PC or MV-based Goldworks.

LISP is not the only artificial language available, although it is the one in which Data General has invested its expert systems. "I recognize that there are only so many LISP programmers out there," Petrofsky said, but he pointed out that the much-talked-about NeXT computer, from Steve Jobs, a founder of Apple Computers, is shipping a copy of LISP with every machine.

"There are really two different perspectives to artificial intelligence," Petrofsky said, "the user's perspective and the developer's perspective. Users see smart programming as a natural way, an intelligent way, of doing things that help one do a job. From the developer's standpoint, we talk about tools to build smart programs." Data General's offering to the market will offer tools to the developers,

smart programming for the user, and a broad range of support for both, he said.

Spaghetti code

"There are two reasons one would want to develop an expert system. One reason is that the application is too complicated. It is too complex for flowcharts. The other reason is the notion of maintainability," said Petrofsky. When a conventional yet complex program has to be changed often, the programmer may end up with spaghetti code.

That was what happened in Data General's International Treasury Department, which determines pricing policies for worldwide sales and shipping. The department was using a COBOL program on a MV, and although the program was implemented only a few years ago, the structure of the COBOL program made it difficult, almost impossible, to keep up with the constant changes.

"Before we developed the knowledge base, much of the policy was written in

Continued on page 21

Data General • Buy • Sell • Trade

Processors

MV20000 Model 1 16MB	SAVE \$
MV20000 Model 2 16MB	SAVE \$
MV20000 Model 1 16MB, FPU	SAVE \$
MV20000 Model 2 16MB, FPU	SAVE \$
MV20000 Model 1 to Model 2 upgrade	SAVE \$
MV15000 Model 20 8MB	SAVE \$
MV15000 Model 8 to Model 20 upgrade	SAVE \$
MV15000 Model 10 to Model 20 upgrade	SAVE \$
MV10000 4MB Meter high cabinet	\$28,000
MV8000-II 6MB Meter high cabinet	7,800
MV8000 Model 9300	1,750
MV7800 4MB 16 slot chassis	8,800
MV4000 2MB	2,800
MV4000DC 2MB, 120MB, floppy	4,500
MV4000SC 2MB (w/MCPI) & as DC above	7,000
MV2000 4MB 160 MB disk	9,800
MPT100 Dual floppy	350
MP100 8520-D	350
S-140 256KB Floating point	2,800
Desktop 10 Floppy, 15MB disk	875
Desktop 20 Floppy, 15MB disk	1,295
Desktop 30 Floppy, 15MB disk	1,495
DG1 256K (Tilt screen)	1,150
DG1 256K (No tilt screen)	900

Processor Options

8997 Expansion chassis MV15, 20	\$7,000
8819 Second IOC	5,500
8762 Expansion chassis MV10, 8, 4, S280	4,500
8761 Floating point unit MV4000	1,500
8749 Battery backup for MV10000	3,200
8746-B Battery backup for 8762	1,800

8704 Floating point unit MV8000	1,900
4543-B MCP1 8 Async 2 Sync DCH Ptr	2,900
4463-ZT USAM-4	475
4380 ISC-2 (Synch)	950
4372-B TCB-16	500
4371-C TCB-8 for expansion	455
4370-A IAC-16 RS422, 20MA	2,600
4368 IAC-16 RS232, 20MA	3,800
4367 IAC-8 RS232, 20MA Modem Cnt	2,100
1625 Power Conditioner 5KVA	950

Disk Storage Units:

6061 192MB Disk subsystem	\$ 1,500
6122 277MB Disk subsystem	2,400
6161 147MB Disk subsystem	2,800
6214 602MB Disk subsystem	3,800
6236 354MB Disk subsystem	7,900
6239 592MB Disk subsystem	12,900
6329 120MB MV2000/MV1400	2,100
6336 71 MB MV2000/MV1400	1,500
6363 160MB MV2000/MV1400	2,500

Terminals:

6053 D2 Monitor with keyboard	\$ 100
6108 D200 Monitor with keyboard	125
6130 D400 Monitor with keyboard	250
6166-X D410 Monitor with keyboard	400
6169-X D211 Monitor with keyboard	325
6391-X D214 Monitor with keyboard (new)	500
6392-X D215 Monitor with keyboard (new)	550
6393-X D411 Monitor with keyboard	600
6394-X D461 Monitor with keyboard (new)	700
Note: Add \$45.00 per unit for Amber Screen.		
6284 D220 Color Monitor w/keyboard	700

Tapes:

6021 800 BPI old style	\$ 600
6026 800/1600 BPI Blue, non FCC	1,900
6026 800/1600 BPI Brown, FCC compliant	3,000
6125 1600 BPI Streamer, FCC compliant	500
6299 1600/6250 BPI Rack mount	17,500
6300 1600/6250 BPI Meter cabinet	18,500
6311 15MB cartridge	1,500

Memories:

MV20000, All sizes
MV15000, All sizes
MV10000, 2Mb
MV10000, 4Mb
MV10000, 8Mb
MV8000, 2Mb
MV8000, 256Kb
MV4000, 2Mb
MV4000, 4Mb
MV4000, 8Mb

Specials	
D 215 (New) Terminal	.. \$550
D 211 Terminal \$325

International Computing Systems
P.O. Box 343 • Hopkins, MN 55343
(612) 935-8112
FAX 612/935-2580



Circle 34 on reader service card.

who helped develop the program. "For example, if we make an international sale, typically an item, a model, or a part has to be transferred from the U.S. to a manufacturing or marketing subsidiary. Transfer policy pricing is the policy we use to determine at what price to make that transfer and that's based on things like international tax law, customs regulations, and foreign exchange control require-

ments. There's some leeway but there are all sorts of restrictions on how you set a pricing transfer. Typically it's based on stated cost or U.S. list price and it's related to how we deal with third party distributors."

The new system is a PC-based inquiry-only system developed using Goldworks. It uses PC*I to go across the network to an MV data base that contains parts in-

formation. Approximately six months were needed to go from a prototype system to an actually fielded one. The advantages of the new system over the old one are numerous, according to Anderson.

"It's more accurate, it's easier to use, easier to maintain, and it has more ways of looking at the information. Previously, the system would let you enter a part and a destination and it would say 'Here's the transfer price.' Now we can use the same knowledge base to say, 'In general, what's the policy for transferring MV/15s to a marketing subsidiary in Belgium?' and it will give you the generic rule for doing that. You wouldn't have to find an MV/15 part and say 'What's the transfer price?'" she said.

In addition to being easier to use and maintain, the new system has a facility that lets users review the computer's decision, Anderson said. "It comes out with additional information about the part: standard cost and list and other things that they previously couldn't get very easily. So it's more complete in that sense. If they want an explanation of how the system arrives at a transfer price they can say 'Please explain this' and it will pop up another screen and give an explanation of how it arrived at the price."

What the future will bring

In addition to hardware and software, new technologies need support services. Data General recently announced that it is offering custom knowledge engineering consulting services through its Artificial Intelligence Group. The consulting service offers a team approach using the skills of a Data General consultant, a client's systems engineer, expert system developer, and end user. These services are available to support various phases of knowledge engineering: application selection, knowledge acquisition, prototyping, design, and system development. Educational services are also offered to train the client and staff about knowledge-based technology.

The re-implementation of the Treasury Department's program as an expert system could not have been done without the development of Goldworks and the Golden Connection. Other innovations are sure to come as Data General explores the many technologies that fall under the catch-all term artificial intelligence. Δ

B32 Means a Winning Performance!



Like an Olympic hurdler, B32 combines blinding speed and amazing agility.

B32 was benchmark tested a full 50% faster than DG Business BASIC Rev 5.0! On a CPU intensive track, B32 was proven to be over 100% faster than Rev 5.0.

B32's additional features mean more Agility:

- Program size up to 512K
- 32767 line numbers and 30,000 variables

- WordPerfect and CEO integration
- Screen Save/Restore facility

B32's performance delays costly hardware upgrades.

Unprecedented speed, performance features, and superior technical support put your system on the Gold Medal podium. Call MAXON today for your *free*, full function B32 Demonstration Tape.

MAXON
COMPUTER SYSTEMS INCORPORATED

AUTHORIZED **Data General** SYSTEM DISTRIBUTOR

Call: (212) 227-1922

575 Madison Avenue
Suite 1006
New York, New York
10022

85 Scarsdale Road
Toronto, Ontario, Canada
M3B 2R2
Fax: (416) 445-6228

Circle 39 on reader service card.

mendations. If a stand is diseased, for instance, the program may be called upon to determine what insect or organism is affecting the stand. Then it will have to recommend the proper treatment, based on the Forest Service's goal for that stand. Some treatments are meant to improve the health of forest stands; others to avoid a change in stands that would be detrimental to wildlife. Sometimes the recommended treatment is to remove and replace an aging stand because it is susceptible to disease. The recommendation might be to change the number or species of trees in order to benefit a particular wildlife habitat or management objective, or to have an impact on the watershed. "There's quite a variety of given treatment alternatives that one could come up with," Chew said.

This variety of alternatives makes the Forest Service's goal an especially challenging one, Reid agreed. "It's a little bit different from using an expert system to diagnose a car engine or something like that. There's just tremendous variability in this. In some ways I think we've picked a hard case to work on," he said.

The system is workable, Forest Service officials say, and it is now undergoing extensive testing. For one of the tests, the expert system and a silviculturist will be asked to diagnose the same stand of trees and the answers will be compared. The question is, how will they know which are the best answers? Δ

Continued from page 19

procedural code, or COBOL code," explained Maurine Hennings, AI program manager for Data General's Information Management Group. "One of the problems was that [in representing policy] you're trying to take data and put as much of it into tables as possible. Usually in a table you have a one-for-one relationship between items and tables. In the case of a policy ruling, you're many times looking at a three-way relationship of information. When you try to represent that in procedural code, that causes a lot of conflict and exceptions."

In the case of the Treasury Department, three factors are put into every pricing decision: the type of part, the destination of the part, and the policy. These ever-changing variables made the program

difficult to maintain—so it wasn't maintained. Seeing these problems develop, Petrofsky's department decided that the re-implementation of Data General's International Treasury Department could be an example of what expert systems do best: take a complicated decision-making process and make it seem easy. In this case, it meant taking the factors that determine policy and dividing them into

discreet units that could be changed without having to adjust the entire code.

In order to do this, programmers had to have training in LISP, the underlying language of Goldworks, as well as Goldworks. They had to understand the PC environment and systems integration.

The elusive policy type is determined by a number of factors, explained System Technology Consultant Betsy Anderson,

Only The Best For Your DG System

The disk subsystem that sets the standards

**FOR YOUR
MV COMPUTER
Argus 623X Emulation
SKS-XX Plug and Play Series**

**FOR YOUR ECLIPSE &
NOVA COMPUTERS
Zebra Emulation
SKZ-XX Plug and Play Series**



ZETA
Authorized
Stocking Distributor

- Up to 1200MB (formatted)
- Only 3.5" vertical rack space
- 5.25" SCSI-interfaced drives, which offer longevity, high reliability, large capacity and a small footprint
- 16.5 msec average seek time (21% faster than DG's 6239 Argus)
- 4.0MB/sec transfer rate

- Up to 620MB
- 5.25" SCSI-interfaced drives
- Only 3.5" vertical rack space
- 18 msec average seek time
- 1.25MB/sec data transfer rate

For Back-up:

The Helical-scan Cartridge Tape Subsystem 2 Gigabytes on a small 8mm cartridge



- High reliability
- Compact Media
- Uses host resident tape drivers and back-up utilities

Up to 40% savings on DG Compatible memories

We specialize in peripheral subsystems

for your DG systems

StorageTek

Dataproducts.

FUJITSU

ZETA

EXABYTE

INTERFACE ELECTRONICS

CONTROL DATA

DATARAM

egaTape

TRIMM

Ask Us About
DATAPRODUCTS Laser Printers



Dataproducts
Authorized
Stocking Distributor

Your First Choice for DG solutions

interscience

COMPUTER CORPORATION
5171 CLARETON DRIVE, AGOURA HILLS, CALIFORNIA 91301

Call
(818) 707-2000

WETA

Circle 35 on reader service card.

CEO CEO Many faces for CEO

Office/Publisher lets users create professional-looking documents

by Joe Cannata
Special to Focus

Loading and using Data General's Office/Publisher rev 2.11 with CEO is easy. With it and a good quality laser printer, you can produce your own professional-looking newsletters, proposals, and legal contracts. Because using Office/Publisher requires some special procedures and skills, I will use the term "publish" to distinguish it from normal printing of CEO documents.

Inside specs

To use Office/Publisher, you must be running AOS/VS CEO Integrated 2.24 or later and have at least one output device supported by Office/Publisher. To merge Data General's GKM graphics you must have 3.00 and one of the following printers: a Model 4558 Desktop Laser Printer with full paint mode; a Model 6454 Desktop Laser with 6456 expansion memory and full paint mode; a Model 6474 running in Hewlett-Packard (HP) emulation mode; an HP LaserJet Plus, LaserJet 500+, or LaserJet Series II printer with 1.5 MB of memory; or a QMS Lasergrafix 800, 1200, 1500, or 2400.

You can create a WYSIWYG (what you see is what you get) environment by using Office/Publisher's PC preview option. This feature allows users to see exactly what the document is going to look like before it is published. To use the pre-

view option, you need a Data General Dasher/286 or XT/AT compatible personal computer running MS-DOS and Microsoft Windows 1.04. You will also need DG/PC*I or Intercon's D410 terminal emulator and file transfer software, plus the hardware to establish a serial connection between the PC and your MV family system.

Inside Loading

Office/Publisher is loaded into a directory called PUBLISHER. You can install the software by following the instructions found at the back of the system manager's reference manual. In addition to this manual, Office/Publisher comes with a copymark reference card and user's manual. These guides are informative and easy to use and were, by the way, created using Office/Publisher.

Publishing is done in a batch stream process described in the installation procedures. Two utilities, PUBSTYLE and PUBUSER, must be run. PUBSTYLE creates a site default style sheet (or page layouts) for the users until they can create other style sheets for their own purposes. PUBUSER is the PREDITOR of Office/Publisher. Every potential user must have a profile under his or her AOS/VS username as well as a default style sheet.

It is essential that you check each user's PREDITOR profile to ensure that the following values have been established: 1) initial program set to :CLI.PR, 2) batch privilege, 3) change address space type set to YES, 4) a disk quota of at least 2,000 blocks. Since Office/Publisher runs as an integrated application under CEO, the system manager must create a public application so that users may access it easily. The PRINTDEF utility defines the printers.

Inside publishing

Publishing a document requires no more than invoking the application. That is the simple part. Creating the formatted output is where skill and creativity lie. Using Office/Publisher is a lot like using CEO Wordview. You take a regular word processing document, add commands, and get the end result.

You may be familiar with CEO Wordview, which uses control commands surrounded by carats. These control commands are not actually part of the document. Office/Publisher uses similar commands, called copymarks, to direct formatting; the difference is that these copymarks are the text overstrike attributes in the actual document. Usually, one skeleton copymark is set up with a function key. This will produce a code surrounded by angle brackets, called boots, as seen here: <Df p-n>.

Copymarks can be placed anywhere in the document. The command letters are changed depending upon the desired function. It is important to realize that once a document has been prepared for *publishing*, it cannot be *printed* like a regular document, because the copymarks will turn into overstrikes and yield jumbled output. Copymarks can only be seen on the screen, and their results can only be achieved after the document is *published*.

Inside text

Different typefaces can be utilized with the various text attributes in CEO. The text attribute for bold, (+), will generate a boldfaced output while the underscore attribute, (_), will generate italic output. Using the (*), or bold underscore attribute, will result in bold italic output. A text underscore option is not supported by Office/Publisher as it is considered improper in the typesetting world.

THE 8MM MIRACLE.



Y

ou'd probably think it was miraculous if somebody offered you a disk backup system like this:

- Stores over 2 gigabytes on a \$10 cartridge.
- "Push the button and go home" simplicity.
- A spectacularly affordable price.

MegaTape has a long history of amazing backup feats. But our new 8mm system, GT-88, will be a real revelation—even to the most jaded computer or workstation user.

Start with uncanny compatibility. That's because the GT-88 is



completely transparent to your CPU. That means you won't have to spend from now to eternity struggling with modified hardware or patched software; your standard backup utilities will work unchanged.

In use, you'll find the GT-88 can create spare time out of thin air.

It equals or beats standard 6250 bpi tape drives in speed—and you'll never have to hang around to change reels or cartridges.

Of course, buying any new technology involves

an element of faith.

So it's worth remembering that MegaTape has been in the backup business—and *only* the backup business—for nearly a decade. Thousands of our cartridge systems are handling daily backup at sites all over the world.

Our support organization is in place, ready to respond in your hour of need.

So if you'd like to work a few miracles around your site, call MegaTape today and find out how affordable the GT-88 can be.

And that's not a suggestion—it's a commandment.

MEGATAPE CORPORATION
1041 Hamilton Road
Duarte, CA 91010-0317
(818) 357-9921 • Telex: 510 600 7131
Telefax: (818) 357-2369

THE GREAT LEAP
FORWARD IN BACKUP.

Publishing Focus

Wordperfect is the keystone for Focus' typesetting and pagination system

The English-speaking world is stuck with yet another misnomer. When a term gains wide usage, even purists have to stop arguing about what's proper. Granted, academic types still insist that "data" is the plural of "datum" and therefore requires a plural verb: "The data are clear on this." They are correct, of course, but that's beside the point.

The same is true of "desktop publishing." In publishing circles, the purist's view is that you're not a publisher if you don't have subscribers—or at least a list of people to bombard with your messages. What passes for desktop publishing is really computer-aided graphic design. "Publishing" is what you do with those beautiful pages *after* they're printed.

Like it or not, the term "desktop publishing" is here to stay. It's important to remember, however, that it's only part of the picture. A complete publishing system has to include components for data communications, word processing, text control, and circulation management, as well as "desktop publishing."

The *Focus* staff has gradually assembled (some would say "kludged") a poor man's publishing system over the last three years. Now we're ready to go public with it. Naturally, desktop publishing plays an important part, but there's a lot more to the story.

It's minicomputer-based

Not surprisingly for a magazine devoted to DG users, the *Focus* staff uses a DG minicomputer for almost everything. We might have gotten much the same functionality from a network of PCs or Macintoshes, but we were concerned about issues like reliability and system management—factors that minicomputer users can take pretty much for granted.

Office automation is a background assumption for the *Focus* publishing system. Electronic mail is a tremendous ad-

vantage for staying in touch with other staff members on the progress of articles without having to devote a lot of time to meetings. The calendar is extremely useful for keeping track of tasks and scheduling activities. The spreadsheet program is absolutely essential: it manages the articles and estimates their length; it organizes all the information about advertisements to be placed; we even use it to produce costing information on individual projects and print invoices for *Focus* advertisers. And of course, there's word processing.



Desktop publishing tools

The OA software we use all comes from Wordperfect Corporation: Library for electronic mail, calendar, scheduling, and a customizable menu shell; Planperfect for spreadsheet; Wordperfect for word processing. The reasons are partly historical—our first system was a DG Desktop Generation Model 30, and *nobody* recommended running CEO on it. By the time we were able to afford an MV system, we had grown too attached to the Wordperfect products to seriously consider anything else. Fortunately, this choice worked out very well because of the way Wordperfect has implemented compatible file structures on its PC and Macintosh products. This turns out to be a very important advantage.

Getting the words

The mail carrier groans under a daily load of press releases and product announcements addressed to *Focus*. In addition, many companies have discovered that we have a Fax machine. After filtering and editing, the relevant items get entered directly into Wordperfect.

Most of the authors and columnists prefer to submit their work electronically. We either log on to their system, or they

log on to ours. Sometimes an author sends a PC diskette, which we load and transfer to our MV/4000. Where feasible, we like to use XMODEM to ensure accurate file transfers. This is especially worthwhile if the author's work is a Wordperfect document. Otherwise, it takes a considerable amount of massaging to convert spaces into tabs, insert boldface commands, etc.

The goal at this point is to take care of as much formatting of the text as possible before handing the articles over to be desktop published. Desktop publishing offers wonderful tools for making things look good, but it's terrible for editing text.

Since several people will be handling each article, we file the articles in an easy-to-remember disk structure: a "cabinet" for each year, a "drawer" for each month, and separate "folders" for text and ads; individual documents are named for their author or subject. Such an open system doesn't keep track of who has edited the text or what changes they made, so we have instituted a manual system that logs each article and who has worked on it. Each article goes through the same sequence of reading, checking, editing, and double-checking.

Onto the page

When an article is finally ready, the editor schedules it for downloading to a Macintosh-based "pagination station." Again, the reasons for selecting the Macintosh were partly historical: we already had two of the old 512 KB Macs, and it was less expensive to upgrade them than it was to start over with PCs. We now have four stations, each equipped with a Mac Plus, 30 MB hard disk, and 16-inch monitor.

The other part of the decision came down to evaluating the differences between two major contenders in the desktop publishing arena: Ventura Publisher vs. Pagemaker. Both are good products, but Pagemaker had certain advantages for *Focus*. First, it is based on the metaphor of the graphic designer's layout table, which is comfortable for graphic designers and more amenable to designing individual pages. Ventura was developed more for producing documents that

The finished product can take on many faces, depending upon your output device. Models 4557, 4558, and 6454 printers will accept font cartridges, whereas the Model 6474 and HP printers will support downloaded fonts. Many fonts are available including Swiss 721, Times Roman, Helvetica, and Century Schoolbook. Intercon sells Interfont font cartridges that include the standard ASCII characters, super/subscript characters, fractions, international letters, and commercial symbols. Intercon will also customize fonts and put graphics and corporate logos on a cartridge. The Interfont cartridges use bit mapped fonts from Bitstream.

In addition to setting typefaces and point sizes, Office/Publisher allows CEO graphics to be merged from CEO Drawing Board, Wordview, CEO Charting, Present, and Trendview applications.

Automatic page numbering, headers, and footers are other Office/Publisher options. Pages can be numbered by page only, page and chapter number, or page and text label. Numbers can be located left, center, right, or verso-recto (alternate left to right depending upon whether it is a left or right page). Headers and footers can accommodate up to 10 lines and they can be left, center, right, or verso-recto.

Inside output

The Office/Publisher menu gives access to diagnostic and preview output, AOS/VS queue status, and request cancelling. When a document is published a diagnostic file is generated in the working directory of the user. This can be typed from CLI or accessed from the utilities menu. Viewing the file will disclose any errors or warnings that could interfere with the output.

The menu also gives access to Tag Image File Format (TIFF) graphics files. Using the HP ScanJet image scanner, a user can copy a TIFF file created by another computer and convert it to use with Office/Publisher.

Office/Publisher is different from CEO Desktop Composer or Ventura Publisher, which work with pre-created pieces. The

Joe Cannata, a training specialist with Data General Educational Services, conducts Office/Publisher training. He can be reached at 7927 Jones Branch Dr., Suite 200, McLean, VA 22102; 703/827-9690.

publishing process with these packages is more akin to electronic paste-up with editing capability. While Ventura is capable of high quality output, it is an MS-DOS based package that must be run on a PC.

Office/Publisher allows you to turn a regular word-processing document into a book-quality published piece with graphics. It is not as elaborate as the other

desktop publishing software, but the amount of time needed to learn how to use Office/Publisher is much shorter; for most CEO users who already know their word processors, the only training needed will be on the placement and use of copymarks. If you need further assistance, however, Data General Educational Services offers a two-day Office/Publisher training course. Δ

TLC EXPRESS TM

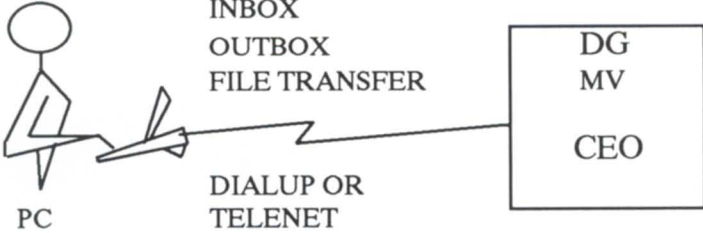

CEOTM Compatible Remote Electronic Mail

TLC EXPRESS MAIL V1.10	MAIN MENU	ESC= Exit, F1=HELP	WED 1/25/89
------------------------	-----------	--------------------	-------------

1. Outbox	Create/view outgoing messages
2. Inbox	View/print received messages
3. Configure	Change phone number, directory
4. Transfer Mail	Send/Receive messages
5. Exit	Quit TLC EXPRESS/Exit to DOS

Copyright (c) 1988, TLC Systems, Inc.
All Rights Reserved

*** Save on Phone Charges**

*** Transfer DOS and AOS/VS Files**

Call us for more information and a demonstration diskette.

TLC Systems, Inc. 508-478-8211

5 Airport Drive, Hopedale, MA 01747, FAX: 508-473-3109

DG, MV, CEO, AND AOS/VS ARE TRADEMARKS OF DATA GENERAL CORP.

Circle 62 on reader service card.



Testing the waters

New products, new choices, new terminology
confront workstation users

by Brad M. Friedlander
Special to Focus

Crazy Grubbs
'89

Just when workstation buyers thought it was safe to go back in the water, in washed a new wave of uncertainty. The PC and MS-DOS had seemed like a secure platform until IBM announced the PS/2 in April 1987. For IBM, the second-generation PS/2 workstations with the new OS/2 operating system represented new computing power, a leap in desktop processing speed, increased direct memory access, better graphics, and, most important, a major redirection in IBM's personal computer strategy. Two years later, however, the market is still making up its mind.

While PCs have become integral to many companies' operations, the introduction of OS/2 and the IBM PS/2 is forcing information systems managers to decide yet again what the proper software and hardware platform should be for the future.

Most potential PS/2 customers are aware that IBM markets PS/2 and OS/2 as indispensable to each other. They also hear that Microsoft licenses OS/2 to numerous other hardware vendors. As if that were not confusing enough, many users aren't sure what would make OS/2 a prudent purchase for them. Their uncertainty becomes harder to bear when they see that their choice of a hardware platform may restrict their options for the entire system, including operating systems and other application packages.

Complex choices

At its most general level, the decision-making process involves measuring present and projected applications against the new hardware and software. The user decision tree in Figure 1 (page 30) illustrates the complex choices. First, the user must define the relevant applications. Then, the application must be mapped onto the appropriate operating system: MS-DOS or MS-OS/2. If these are constrained by memory size, OS/2 can be a viable option. If the applications require multitasking, OS/2 again becomes the choice. In contrast, if they are not constrained by memory, do not require multitasking, and do not need the sophisticated, memory-intensive graphical interface of Presentation Manager, MS-DOS is adequate. If the demand is for only a modest graphical interface, users can run MS-DOS with Microsoft

are essentially similar from page to page. Pagemaker also offers simpler printing, because it prints directly to Postscript devices, rather than producing Postscript output files that have to be queued to the device.

Two of the *Focus* pagination stations are wired directly to the MV/4000. Using Versaterm for DG terminal emulation, they can log on and initiate a binary XMODEM file transfer of the Wordperfect documents. So far, so good. The next step is to prepare the file to be "paginated" with Pagemaker. A little sleight of hand is necessary here, because the current revision of Pagemaker hasn't learned to recognize Wordperfect files. However, it *does* recognize Microsoft Word documents, and since Macintosh Wordperfect can save a file in MS-Word format You get the picture.

The first pass through Pagemaker produces laser printed "galleys"—the document is produced in the proper font and column format, but with no other design work. The galleys allow the editors to gauge the length of the article while the author gives it a check for accuracy. Meanwhile, the graphic artists are at work planning placement of ads and cooking up illustration ideas.

All of this comes together during the eight-day production cycle, during which editors, ad sales staff, and artists go through as many rounds of corrections as it takes to make them all happy—usually from two to five versions of each page.

The staff keeps a "dummy book" of each issue, which documents the production cycle with laser-printed copies of each version of each page. By the time the magazine is ready for the printer, the dummy book fills two large three-ring binders.

When everybody is satisfied, the artists deliver Macintosh diskettes with the finished Pagemaker files to our typesetting vendor. It usually takes only a few hours to produce "slicks"—the full-page typeset film produced by the typesetter. The final step is to mount the slicks on art boards, produce detailed instructions for the engraver, and box up the whole thing for shipment to our magazine printer.

Summary

Publishing remains a labor-intensive process, even with the help of excellent tools. Desktop publishing is one of those

excellent tools, but it will hardly put graphic designers out of business. In fact, as many people have already discovered, a graphic designer's touch may be more necessary than ever: it's hard to mess up a plain typewritten page, but when you put hundreds of type styles at the disposal of people who aren't trained to use them, the results can be anything but pleasing.

Desktop publishing doesn't make every user a publisher any more than electronic mail turned all of us into letter carriers. The real role for desktop publishing is to put better tools in the hands of people who can use them with skill and judgment. The same is just as true for the other excellent tools that are now available to help manage and improve the many tasks that are part of publishing. Δ

For Sale or Lease

MV/20000 MOD 1 CPU:

- Available Early March 1989
- Currently under DGC maintenance
- This is a large system with many options and peripherals but we can down-configure or up-configure to your specifications

UPGRADES:

- UVIK-G IOC2 Upgrade for MV/20000
- UVIK-H IOC2/3 Upgrade for MV/20000
- UVIKW-A MV/20000 MOD 1 to MOD 2
- U15810 MV/15000 MOD 8 to MOD 10



**CATALINA
COMPUTERS, INC.**

1001 W. Arbor Vitae St., Inglewood, CA 90301

(213) 215 - 0641

FAX # 213/649-1065

Circle 4 on reader service card.

Figure 1: User decision tree

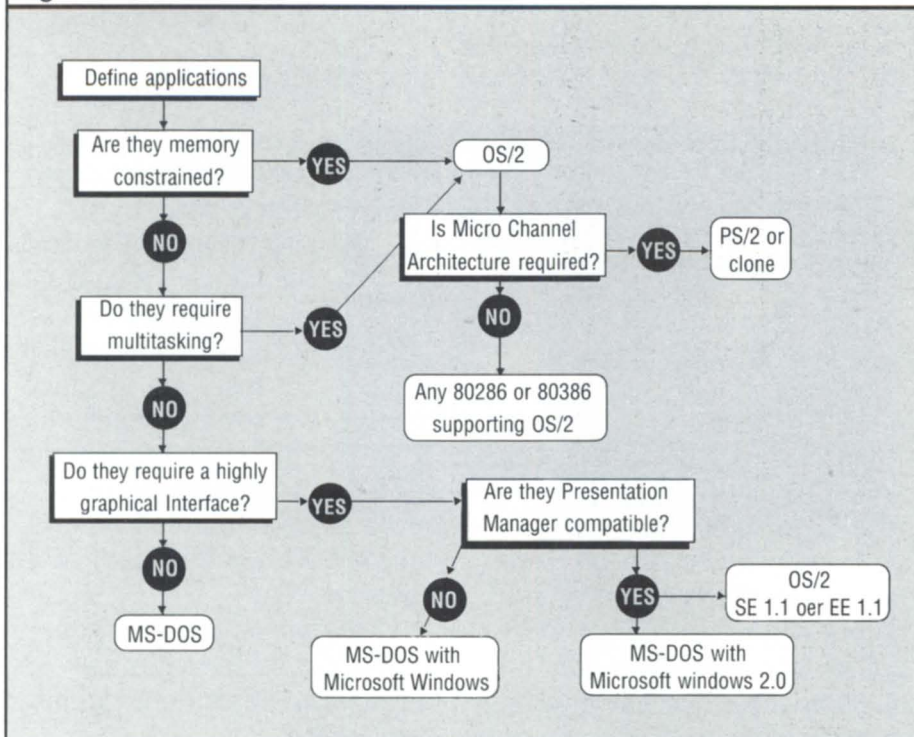

Windows 2.0, which can access Presentation Manager-compatible programs.

For those applications that consume large amounts of memory or require multitasking, the decision to go with OS/2 leads to related hardware choices. If the Micro Channel Architecture (MCA) is not required, any 80286 or 80386 computer that supports OS/2 is adequate. Only where MCA is needed should the user turn to an IBM PS/2 or clone system.

If the user decides on a PS/2 or clone, the next choice is between IBM's and another licensee's OS/2. Users also have the additional choice of Standard or Extended Editions of OS/2. Buying another licensee's OS/2 instead of IBM's precludes the use of IBM's Extended Edition (EE), which integrates data base and communications capabilities with the SE. However, other vendors should soon provide equivalent functions that will operate under any OS/2.

Not going with IBM's version of OS/2 also means not having to pay for the MCA and PS/2. (Pay is not just the relatively

DG/500 Subsystems



The VAULT 380/780

High performance, high capacity disk drive subsystems.

- 380MB and 780MB capacity
- 16ms access time
- 4.0MB/sec. transfer rate
- internal mounting or desk-top enclosures
- complete with hardware, controller, cables and installation instruction.

The PACER

The high capacity cartridge tape subsystem.

- ¼" cartridge
- 150MB of storage
- 90KB/sec. transfer rate
- small footprint
- internal mounting or desk-top enclosure
- complete with controller, cables and mounting hardware.

The SPRINTER

The ultimate in lightning-fast tape backup.

- VHS Technology
- 1.5MB/sec. transfer rate
- 8mm cartridge
- available in an attractive desk-top enclosure for convenient access.

SIGNAL COMPUTER PRODUCTS Inc.

411 Massachusetts Avenue
Acton, Massachusetts 01720
(508) 263-6125

Your Authorized Data General VAR

Circle 53 on reader service card.

ETHERNET TCP/IP NETWORKING FOR ALL DG SYSTEMS

- Industry standard TCP/IP LAN connections for AOS/VS, AOS and RDOS systems.
- Connects DG systems to non-DG systems such as VAX, IBM-PC, SUN and APOLLO.
- High speed file transfer using the standard FTP protocol.
- Virtual terminal remote logon using the standard TELNET protocol with VT100 terminal emulation.
- Supports ECLIPSE/MV, ECLIPSE, NOVA and DESKTOP systems.

CLAFLIN & CLAYTON, Inc.

117 Maynard Street, Northboro, MA 01532

(508) 393-7979

FAX 508/393-8788

Circle 6 on reader service card.

The SAS[®] System

The Graphics Tool You Won't Outgrow.

When you've got to turn those numbers into a presentation, turn to the SAS[®] System. The SAS System includes easy-to-use procedures for charts, plots, maps, and three-dimensional displays. At a glance, you can grasp detailed statistics, spot relationships among items, and trace emerging trends. And when your manager wants more, the SAS System lets you customize your graphs and present multiple displays on the same page for easy comparison. You can produce your graphs on terminals, plotters, transparencies, or slides.

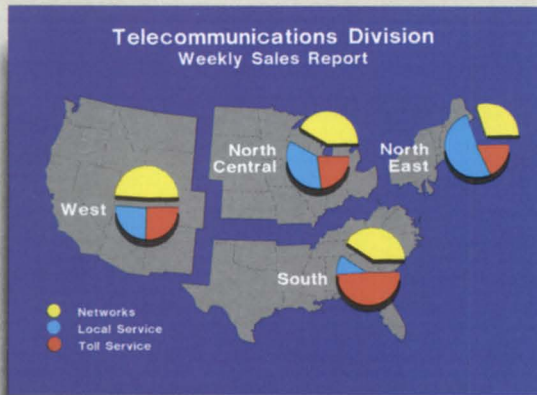

You can even use the SAS System to analyze your data before you present them. We've got tools for every kind of analysis—from simple descriptive statistics to advanced regression, analysis of variance, discriminant analysis, clustering, scoring, and more.

And as your needs grow, the SAS System grows with you. All the tools you need for full screen data entry, modeling, forecasting, "what if" analysis, project management, optimization, and quality control are

available in the SAS System. You choose the products you need, and enjoy the same easy-to-use language and syntax in each. Whether you license one product or several, you'll enjoy the same high-quality software, training, documentation, and

support we've offered for more than ten years.

For details, send us your name and address. Or call a Software Sales Representative today.

The SAS System. It's for those who need a graphics package today, and for those who have an eye on tomorrow.

SAS SAS Institute Inc.
 Box 8000 □ SAS Circle
 Cary, NC 27511-8000
 (919) 467-8000
 Fax (919) 469-3737

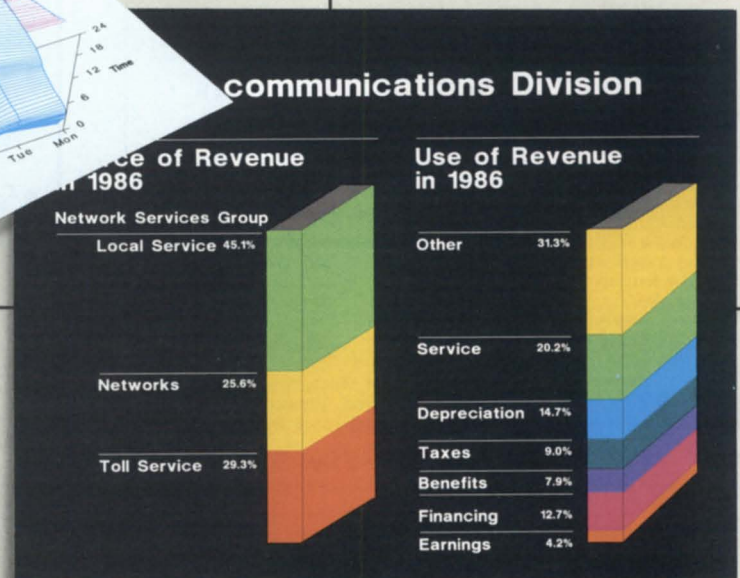
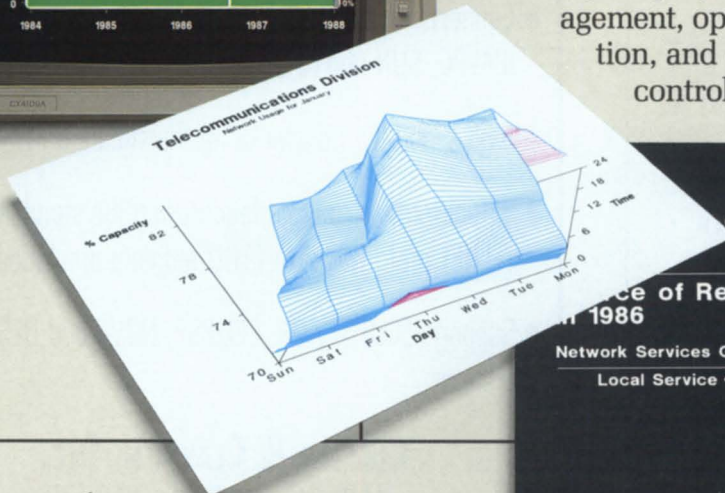
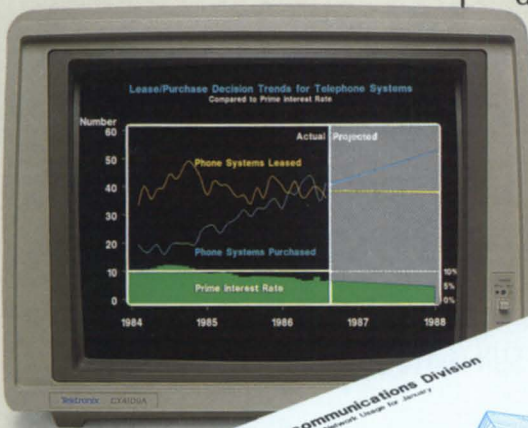

The SAS System runs on these minicomputers: Digital Equipment Corp. VAX[™] 8xxx and 11/7xx series under VMS[™] and MicroVAX II[™] under MicroVMS[™]; Prime Computer, Inc. Prime 50 series under PRIMOS[®]; and Data General Corp. ECLIPSE[®] MV series under AOS/VSE. The SAS System also runs on IBM 370/30xx/43xx and compatible machines under OS, CMS, DOS/VSE, SSX, and ICCF; IBM XT/370 and AT/370 under VM/PC; and IBM PC XT and PC AT under PC DOS. Not all products are available for all systems.

SAS is the registered trademark of SAS Institute Inc., Cary, NC, USA.
 Copyright © 1986 by SAS Institute Inc. Printed in the USA.

basic questions must be answered:

- What applications does our business need?
- What operating system will best support these applications?
- What hardware platform will best support the operating system?

Because the hardware decision should come last, I will defer a fuller discussion of the hardware options to a later article.

But in the meantime, what about the factors that affect the selection of an operating system?

Software availability

The primary issue is that programs designed to run under OS/2 will not run under MS-DOS, and vice versa. For that reason and a variety of other considerations peculiar to OS/2, the issue of MS-

DOS versus OS/2 is not a question of simple cost/benefit analysis. Figure 2 summarizes some of the relevant factors, but potential buyers should also consider the following:

- Various versions of OS/2, from both IBM and other licensees of Microsoft, are already on the market—and more will come.
- The current versions of OS/2 are really for systems based on the Intel 80286 chip and do not take full advantage of the 80386.
- OS/2's potential for multitasking and large memory addressing are unnecessary for many people, but make the system a great boon for a few.

The lack of software stands out now as a primary deterrent to prospective OS/2 purchases. While numerous vendors will port their products to OS/2, the initial products will do little that they don't do under MS-DOS (although perhaps they will do it faster and without the memory constraints). Most products that are currently available are not Presentation Manager versions and are almost identical under MS-DOS and MS-OS/2. Some Presentation Manager applications (like Sidekick) are totally incompatible with the MS-DOS version. Users who look to OS/2 for software that will perform applications now impossible under MS-DOS must still turn to custom programming or do without. It will be many months or even years before these packages justify buying OS/2 products.

For all its quirks and esoteric command structures, MS-DOS runs on all Intel chips from the 8086 up. OS/2 requires at least an 80286. Based on current announced OS/2 plans, an Intel 80386 based system is probably the minimum platform to acquire for OS/2. More significantly at this stage, MS-DOS offers many thousands of commercial programs at costs acceptable to business customers.

Already, the anticipated release dates of many OS/2 products have been slipping. In addition, it will not be until Presentation Manager has been in software developers' hands for at least several more months that users will see a difference in the screen interface for their programs. Furthermore, the OS/2 capabilities of multitasking and addressing additional memory will remain underutilized until vendors create the needed device drivers to take advantage of these capabilities.

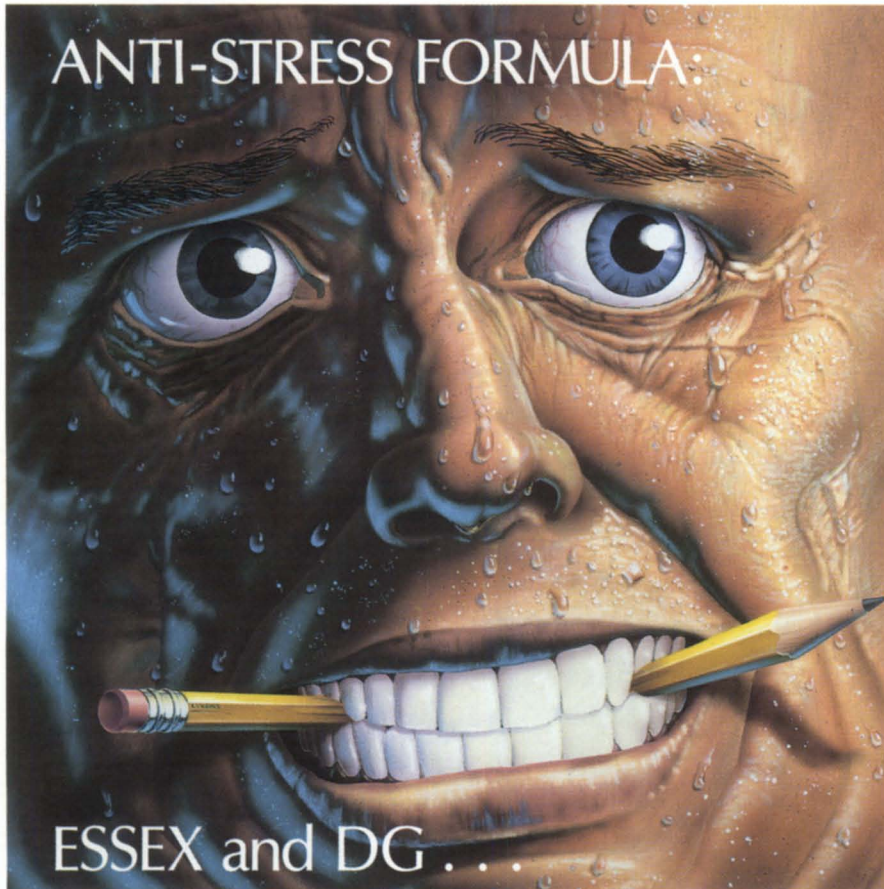

SYSTEMS BUILT TO TAKE THE HEAT

Is the pressure up because your system throughput is down?

- Terminal response inadequate?
- Tape backup take too long?
- Running out of file space?
- Need to add more users?
- System memory size too small?

If your computer system has any of these symptoms, it may be an indication of the "Peripheral Blues".

Let Essex Computer prescribe a cure by supplying direct from inventory;

quality products from manufacturers such as:

Data General®
 PERFECT FUJITSU
 WYSE OKIDATA
 H.P. DATA PRODUCTS
 STC CDC
 ZETACO MICOM
 DATA RAM

All equipment is fully guaranteed, with maintenance and installation

available from Essex Computer Service's staff of factory trained technicians.

Essex
 COMPUTER SERVICE, INC.
 263 COX STREET, ROSELLE, NEW JERSEY 07203
 (201) 245-8300

FAX 201 245-2509
 1900 Market St., Philadelphia, Pa. 19103

* Registered trademark of Data General Corporation

Circle 28 on reader service card.

small initial investment in new hardware and software. It also includes: scrapping peripheral boards (along with some devices); replacing or upgrading application software; and retraining users and support personnel.) Microsoft's OS/2 runs on 80286s without the MCA; however, this alternative eliminates the possible future advantages of incorporating peripherals and software specifically tailored for MCA. For users, this decision can be difficult, especially since specific advantages of the MCA (IBM claims increased throughput and speed) are still debated.

Considering that most routine business applications do not require OS/2's capabilities, there may be a substantial advantage in waiting a year or two until new products and the market's judgment make it clearer which combinations of OS/2-based products are significantly better than the MS-DOS environment.

Decisions regarding personal computers are no different from decisions about any other computer system. The same

Figure 2: Comparison of operating system choices

	MS-DOS	IBM's OS/2 SE and EE	MS-OS/2
Applications software	Much currently available	Very limited at present	Very limited at present
Graphical user interface	Presentation Manager-compatible user interface with Microsoft Windows 2.0	Presentation Manager	Presentation Manager
Other features	Runs on Intel 8086, 80286, and 80386 Addressable memory of 640 KB	Runs on 80286 and 80386 Multitasking Addressable memory to 16 MB, plus virtual memory of unlimited swapping of data with hard disk OS/2 EE has integrated data base and communications capabilities	Runs on 80286 and 80386 Multitasking Addressable memory to 16 MB, plus virtual memory of unlimited swapping of data with hard disk Licensees and third parties will add capabilities similar to IBM's EE

Source: Arthur D. Little, Inc.

PopTerm

Memory-Resident
Hot-Key
Terminal Emulator
D410 and
40 other CRTs

PC/VS

The High-Performance
LAN-Based
PC Integration
Alternative

Now Novell-Compatible!

Solutions

for Every
PC Integration
Problem

Call for your free copy of the
RDS Report on PC Integration

PC/Mail

CEO-Compatible
PC-Based
Electronic Mail

New!

PC/Remote

LAN Functionality
Using just a Modem
or Direct Asynch
Connection



Rational Data Systems
150 South Los Robles Avenue
Suite 410
Pasadena, California 91101
Phone: 818/568-9991
FAX: 818/568-9990

Circle 45 on reader service card.

grams, running in background. The same situation applies to MS-DOS.

Device and presentation drivers

Perhaps the stickiest question for operating system vendors will be that of the device and presentation drivers. The drivers for various peripherals and subsystems are totally different in OS/2 and MS-DOS. The presentation drivers are not

required in MS-DOS except with Microsoft Windows. A conceptual representation of each system appears in Figure 3.

Device drivers manage the physical interaction of the device and OS/2. Presentation drivers manage the translation of generic display functions (e.g. bold and font size) into the device dependent commands.

Software running under OS/2 requires

drivers for the users' devices, either from the software vendor or from the users. In addition, the Presentation Manager will require additional drivers to interface its functions with various display and printer hardware.

Standard or extended edition

The OS/2 Standard Edition is available now from Microsoft and numerous vendors who add their own device drivers while keeping the system compatible with the standard.

Why Join NADGUG?

Reason #11

Free Software

Is the high cost of software keeping you from adding capabilities your users want? The North American Data General Users Group can help. For just \$40 a year your membership gives you access to dozens of useful programs and macros in the NADGUG software library. But that's not all. You also get monthly issues of *Focus*, access to the RIG/SIG

**NORTH AMERICAN
DATA GENERAL
USERS
GROUP**

network, electronic bulletin boards, a member directory, discounts on annual conferences, and much more. Best of all, you become part of a network that lets you exchange information and ideas with other DG users. Join today, and enjoy NADGUG's software library — and all the other benefits of belonging.

(1-800-USR-GRUP)
512/345-5316 (outside U.S.)

Figure 3: Exploded view of OS/2 and MS-DOS

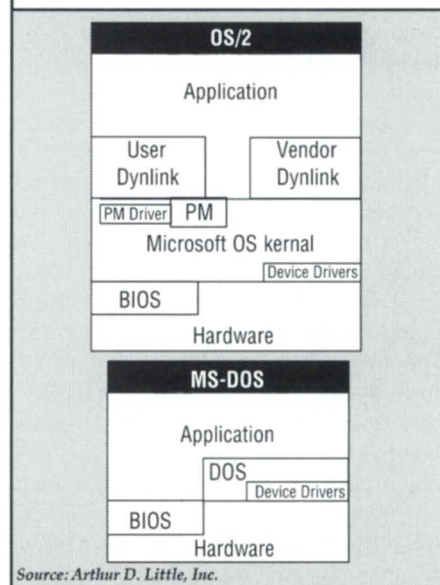

The Extended Edition is a proprietary product of IBM and is also available today. OS/2 EE is fundamentally the same as the OS/2 SE version, but it has additional dynamic link (dynlink) libraries (collections of subroutines shared among programs) that provide special functionality and some additional I/O drivers. Access to dynamic libraries is very similar to AOS/VS inner-ring calls. Dynlink does not bind the library to the program before it executes, so it allows users to switch libraries while the program is executing. IBM differentiates the OS/2 EE with SQL (Structured Query Language) data base and communications interfaces. This positions the product well for large corporate users in IBM networking environments where SQL is the norm.

Other vendors can and will provide similar functionality. Some will concentrate on other popular data bases, such as Oracle. Users should expect SE and EE

Multitasking and expanded memory

Multitasking is when a single PC can execute two or more programs concurrently, allowing the user to make better use of time otherwise spent waiting for a massive computation, file I/O, or data communication to finish. OS/2 supports the same levels of multitasking as RDOS, AOS, and AOS/VS. This includes multiple concurrent processes and concurrent tasks within a single process. The latter is a key difference between OS/2 and Unix.

Multitasking ranks as the great potential of OS/2. Only since 1988 have a few operating environments layered over MS-DOS been able to perform true multitasking. However, setting up the software for such multitasking is often tedious and arduous for many users.

In general, however, multitasking is not only beyond the need of most users, but is also not the way they are accustomed to working, and is often inconsistent with the way they have been trained. Users doing even sophisticated word processing seldom if ever will need background computation or communication. Print spooling, which is widely available in the form of printer buffers under MS-DOS, is the most a typical user would require. Having the ability to switch quickly from one program to another is useful to many, but since this can be done under MS-DOS today it does not, by itself, justify buying the more expensive OS/2 environment.

On the memory side, OS/2 can directly address up to 16 MB of memory without requiring switching between banks of chips (one MS-DOS approach). Software that writes large blocks to memory should be easier to use under OS/2 than under MS-DOS, which has a maximum application-usable address of 640 KB. When an OS/2 program needs more RAM, the operating system hunts for chunks of unused memory and logically consolidates them, creating larger segments into which data can be moved. If memory is short—maybe because of heavy multitasking—OS/2's virtual memory kicks in and begins swapping segments to and from the hard disk.

Yet for the moment, only a few "power users" in a typical firm have spreadsheets or decision-support programs that require more than 640 KB. These users are good candidates to migrate to OS/2 now. A good strategy is to start by buying a small number of systems, which provides a cost-

effective way for companies to sample the technology without committing to a large-scale conversion.

Multiuser ability

OS/2 will not inherently accommodate those people looking for multiuser systems. IBM's OS/2 RPG II program is a special application supporting dumb terminals and is intended to be the only

application running on the machine. By design, all versions of OS/2 are made for a single user and give the current inputs from that user immediate precedence over any other task. For example, a command from the "active screen group" (the monitor, keyboard, and other input devices) could interrupt any other task under way. This would disrupt time-sensitive applications, such as telecommunications pro-

FROM THE COMPANY THAT WROTE THE BOOK ON MANUFACTURING SOFTWARE

The JAI Software Library™

Designed by manufacturing people and written in manufacturing words—the JAI Software Library is in a class by itself.

Built on a modular basis, the Library allows you to mix and match as you choose to get a fully integrated system that's just right for you. And for people who want to customize, there's plenty of room for that too.

You can expect immediate results like improved customer delivery, lower investment, greater visibility of operations, and improved financial controls. All conveniently provided by a company with over 18 years of hands-on experience.

To learn more about our vast selection of Library programs, give us a call today.

JAI: Our Experience Speaks Volumes



JACOBSEN & ASSOCIATES, INC.

10229 Lower Azusa Road, Temple City, California 91780
(818) 575-7504 • (213) 283-5347

Circle 36 on reader service card.



NOW, who's in charge?

Now with **IC/TOOLBOX** you can take control of your DG/ICOBOL System. We've added powerful new routines and upgraded old ones.

IC/TOOLBOX Revision 1.50

- Communicate with IBM 2780, 3780, 3271, 3277 systems as a controller or remote station.
- Read/Write-Ascii/Ebcdic Tape directly.
- Change process type/priority directly.
- Proc up sons directly with full control.
- Set time-outs for console lines.
- String/Unstring/Inspect/Parse/Insert/Delete on character data of any size.
- Read/Write any length record at run-time.
- Read .XD files sequentially not thru key.
- Send/Receive/Manage IPC messages.
- Convert Ascii-Ebcdic either way in program.
- Communicate with Burroughs TC/500/700 Poll Select terminals as a controller device.
- Convert BCD (COMP3) data <-> Decimal.

Whether you are a systems manager, a consultant or programmer trying to speed up processing and development time **IC/TOOLBOX** allows you to be in control. You get complete sample programs, copy books for all routines & variables, a comprehensive reference manual with extensive examples, plus free technical support during business hours.

Put IC/Toolbox to the test!

Cost for MV/2500 is \$295! If at any time during the first 30 days you are not completely satisfied return invoice and media and pay nothing.

COMPUTER ARTS
(803) 238-1688

717 3rd Avenue North
Surfside Beach, SC 29577

Circle 10 on reader service card.

to the shops—about a hundred specialty stores inside a beautiful mall stretching nearly three blocks along the Mississippi. Then we were there, and the Board members' jaws began to drop.

The lobby area of the convention center is bigger than a lot of airports. The meeting rooms upstairs are large and well-equipped. Each of the three exhibit areas would be big enough to house several Goodyear blimps—and each has a glassed-in catwalk above to give a panoramic view of what's going on below.

If you take into account only the facilities, this could easily be our best conference yet. But obviously it takes a lot more than facilities to make a conference. That's where Jan Grossman's Conference Committee comes in.

Jan has been working since last fall to get plans underway for the conference program and activities. The theme this year, "Emerging Technologies—Changing the Challenge," has a special appeal considering Data General's new strategies with RISC/Unix and communications. The call for presentations has already gone out, and early returns lead us to think there will be more and better sessions than ever before. Once again, the sessions will be arranged around separate "tracks" for end users, technical users, and management. There will also be room in the exhibit hall for as many as 100 booths—nearly every company that displayed its products last year will be back, along with quite a few new ones that have already expressed interest.

Jan's committee is also working on several little extras for attendees, including a packed social program, an expanded spouse program, and a special conference bonus—the 1989 T-shirt! (It'll be hard to top the shirts from Las Vegas and Philadelphia.)

If you've never been able to make it to one of NADGUG's conferences, I urge you to put Conference 89 on your calendar now. Travel and housing will be a bargain this year, and the conference remains one of the best ways I can think of to further your professional education, check out new products, talk about common problems with other DG users, and make your views known to Data General.

This year's spring board meeting was routine in many ways, but quite exciting in others. In years past we often spent hours reviewing the status of Regional and Special Interest Groups, but Charlene Kirian's RIG/SIG Committee has streamlined that process down to a few minutes. Likewise, the Publications Committee needed only a few minutes for its report. However, there were three areas that got a lot of extra attention.

First of these was the new Membership Committee chaired by Bart Bates. This committee was formed last Fall to focus extra attention on NADGUG's commitment to grow and extend new services to our members. Bart got off to a strong start when he presented a long list of suggestions that ranged from the obvious to the esoteric. The thrust of all of them was that NADGUG needs to strive for more visibility in the DG community by doing more for members. Part of this is marketing—getting people to see that NADGUG is working for their best interests. In addition, the committee is looking into additional services the group can offer to make NADGUG an even better deal for members.

For its part, Data General made a more substantive report to the Executive Board than ever before. In addition to the DG personnel that are directly responsible for working with the user group, we had presentations from two Franks: Frank Kenney, manager of DG's software business group, and Frank Keaney, DG vice president and a longtime friend of NADGUG. Both discussed the friction that developed between users and DG over the introduction of AOS/VS II last fall. The message from each Frank was that DG is committed to work harder to communicate with users and avoid conflicts like this in the future.

Finally, NADGUG budgets got a very thorough going over. This has been a problem area for the group in the past; we didn't have a formal process for reviewing expenditures against budgets, and committee chairs had a hard time getting a summary of their expenditures. That should change now, because we are putting all of our accounting on NADGUG's computer. It is my sincere hope that by this time next year, budgeting will become another one of those Executive Board responsibilities that will become quite routine. △

versions of OS/2 from various hardware and software firms.

User interfaces

Underlying the concepts of IBM's OS/2 SE and EE are the two Systems Applications Architecture (SAA) user interfaces. The OS/2 SE version 1.0 is text-oriented, designed to work with such programs as Lotus 1-2-3. The Presentation Manager provides a separate, graphics-oriented interface more typically associated with drawing programs.

Users who need a single graphics-oriented user interface have a choice between PM under OS/2 SE 1.1 (or EE 1.1) and Microsoft Windows 2.0 under MS-DOS. However, the program source code is not quite compatible. Both will provide the same functionality and appearance and limit the amount of support needed. Together, the operating system and interface choices place constraints on the hardware and software that will run on them.

Conclusions

If nothing else, the availability of OS/2 will force many users to analyze their PC use and expectations. Right now, most people rushing to purchase OS/2 will pay a lot and get little. The operating system and supporting hardware are more expensive than MS-DOS systems, and virtually no software exists that takes full advantage of them. Prices will drop within the next two to three years, while the functionality will increase over the same period.

Two sets of users who are immediate prospects for OS/2 are those who need a highly graphical, interactive user interface with mouse or similar input device accessing icons and windows, and those who need the ability to run several background activities that consume a fair amount of processing on their own concurrently. This universe is extremely limited, probably

Excerpted with permission from PS/2 and OS/2 in Practice: User Decisions and Vendor Dilemmas, published by Arthur D. Little Decision Resources. The author, a member of Arthur D. Little's Information and Telecommunications Systems Section and a past president of NADGUG, specializes in mixed-vendor multiple-host networks, intelligent workstations, capacity planning, and performance analysis. He can be reached at Arthur D. Little, Acorn Park, Cambridge, MA 02140; 617/864-5770.

less than 1 percent of all users.

Another issue users face is whether to keep a single PC environment or convert to a multiple environment. At first glance, maintaining a single environment seems easier. However, it becomes more complex when a single user or a small set of users need OS/2. Then, in order to give each user what is needed, the business will have to be capable of migrating in-

crementally from MS-DOS to OS/2.

Until the products proliferate, many customers may make best use of their PC resources by purchasing a few OS/2 systems to get an idea of their performance on existing applications. Only when it becomes obvious that OS/2 offers something clearly superior is it likely to be a good decision to convert to that environment. Δ

NEW & IMPROVED!

DG Color Graphics Terminal Emulator for IBM Micros.

Comprehensive products
spanning the entire
Dasher Terminal Line. \$95 to \$195.

Terminals Emulated	Graphics Boards	File Transfer	Bonus Features
D470C	VGA	XMODEM	Compressed Mode
D461	EGA	Kermit	70+ Macro Keys
D411	HERCULES	File Capture:	Auto Dial
D220	MCGA	• Text	Auto Logoff
W460	CGA	• Binary	Unlimited Config. Files

EMU/470™

Version 2 Now Available

- Higher Speed • Same Low Cost • Free Support
- Volume Discounts • Technology Leader



Rhitek, Inc.

P.O. Box 220
Columbia, Maryland 21045
301-730-2575

VISA and MC accepted.

Circle 47 on reader service card.

Office party

New features make Wordperfect's Office a strong OA contender

Any visitor to last year's NADGUG conference could have stopped by Wordperfect's booth to "kick the tires" of three different versions of the company's entry in the office automation road race. The official entry was "Library," a product that has been on the market for about two years. However, with a minimum of ingenuity, visitors could also peek under the hood of two prototypes for future revisions. One of these will soon be released as "Office," a successor product to Library.

Wordperfect recently sent *Focus* a beta-test copy of Office to put through its paces. With about two months to go before formal release of the product, neither the documentation nor the programs were in the final, polished form that users expect from "shrink-wrapped" software. However, with a very few exceptions (which I'll go into later), everything installed and ran smoothly.

Considering the controversy that erupted over DG's new versioning policy for AOS/VS, it's natural to ask how Wordperfect will handle the transition from Library to Office. According to Guy Pribyl, marketing manager for Wordperfect's DG products, Office will replace Library, and customers who have been paying for software subscription will receive the upgrade without additional cost. Otherwise, there will be an upgrade fee. Pribyl said that Wordperfect will provide limited support for customers who opt to stay with Library: it will attempt to fix outstanding bugs, but does not intend to enhance the old product.

Like its predecessor, Office is designed around a tailorable menu shell that inte-

grates electronic mail, appointment calendar, and phone message capabilities. Office also offers two new features: a full-function calculator and a "notebook" (really a flat-file data base that can serve a variety of functions; one obvious use would be as a name and address file). One feature of Library that is missing from Office is the appointment scheduler.

Customers can buy Office either by itself or as a package that includes other Wordperfect products—especially the word processor and spreadsheet. Doing so will let them use "hot keys" to move quickly between applications; a "clipboard" and compatible data formats make it relatively easy to cut and paste data from one application into another. In addition, the Office main menu can be tailored to call other user applications and submenus.

That's what Office is supposed to do. The obvious next question is whether it performs as advertised. With one exception (probably temporary), the answer is, "yes." The exception was the notebook, which was not available at the time we ran our tests. According to Jeff Hall, Wordperfect's manager of DG testing, "This is the only part of Office that isn't completely ready. We're committed to begin shipping within 90 days, and this is the newest part of the product. Everything else has been out there a while and has been pretty well tested."

The installation instructions were simple and accurate, and the whole installation procedure, including reading the instructions, took only about two hours. I was surprised that there were two release tapes—one for Office and the other for Wordperfect's program editor, P-Edit. A review of the installation instructions explained that a P-Edit macro called `ADD_DISK_FIELD` would convert Library's user information files into the

format used by Office.

In other words, P-Edit was there to handle the conversion from Library to Office. That's considerate, but it seemed odd to do it in a way that required them to ship a copy of P-Edit (for which they normally charge a license fee). This had the look of an interim solution—it seems likely that there will be a simple standalone conversion program by the time Office is formally released.

However, I soon discovered that P-Edit revenues wouldn't suffer even if `ADD_DISK_FIELD` turned out to be the permanent solution. All Wordperfect products now use an anti-piracy lock that requires the user to type in a password to unlock the program after installation. The lock gives Wordperfect the option of setting both an expiration date and a maximum number of users for any product they ship.

Regardless of how the conversion is handled, it is a conversion. New features in Office make it incompatible with Library. `ADD_DISK_FIELD` takes care of only one of the differences (it adds a field to each user record so electronic mail can be spread across many disk drives). Mail groups will have to be reentered, and old mail messages from Library can't be read into Office. The data from the Library calendar is usable in Office, but not vice versa. Menus and submenus that were created or modified in Library will have to be redone in Office.

For current Library sites, it would be wise to think through the differences in the two products before undertaking the upgrade. For example:

- If your users like to keep old mail messages as reminders of things to do, give them plenty of time to move their reminders onto the calendar's to-do list.
- If your site uses Library's scheduler, you may need to stay with Library, be-

cause Office doesn't have a scheduler at this time. (Wordperfect's Hall said he expects that a future revision of Office will bring back the scheduler.)

• If your site used the tailorable menus and submenus to give individual users only the menu choices they actually use, then give yourself plenty of time to recreate all those menus in Office.

If these changes annoy current Library users, it's worth remembering that the differences are there for a reason. Office has significant features that weren't in Library. Also, many of the features that were in Library have been streamlined or improved in Office.

For example, the calendar in Office is a significant improvement. One window shows about eight weeks of dates, while three other windows list memos, appointments, and a to-do list for the current day. All are visible at the same time. The calendar also offers almost as much control as a word processor over how the information looks. It's possible to use boldface or underlining to make some items stand out on the screen, and extensive printer controls are available—including a print preview option. The windows shrink and grow automatically to show as much information as possible, and Macintosh-like scroll bars show whether lines of information have scrolled off the window. Other Mac-like features include the ability to cut and paste memos, appointments, and chores into other days.

Two other calendar features deserve a mention. "Date difference" automatically calculates the number of days from one date to another. "Auto-date" will automatically write a memo, appointment, or chore into every date that matches the criteria you set. A superstitious person, for example, might remind himself to avoid black cats on every Friday the 13th for the rest of his life.

Electronic mail in Office uses "envelopes" that can contain a message and/or a file. This system takes some getting used to, but once you master it, it works well. There are also many options for controlling how the envelope is sent: urgent, encrypted, return receipt, auto-delete when read, etc. All of these options can be set either globally, or for individual messages. The mail outbox also provides a lot of new information, including the time and date a message was opened and

deleted. In addition, E-mail provides full control for printing both messages and files.

When mailing to a defined group of mail users, it's possible to list the members of a group to your screen, then designate whether each individual is to receive a carbon copy, a blind copy, or be excluded altogether. If mailing to more than one group with overlapping memberships, E-mail sends only one message to each recipient.

The Office calculator features separate modes for programming, scientific, financial, or statistical calculations. It will also keep a "tape" of the calculations and entries that can be saved as a disk file or cut and pasted into other applications. By referring to the on-line help I was able in just a few minutes to figure out how to calculate the principal balance remaining on my home mortgage—and the answer agreed with my Canon financial calculator.

As noted above, the notebook data base wasn't available for review. However, if it works as described in the manual (or as it is currently implemented in Wordperfect Executive for the PC), this will be a welcome addition to most desktops. Imagine being able to set up a Rolodex file from which you can select individual names, and then directly produce a merge file for doing a mass mailing.

All of this persuaded me that Office is a significant improvement over its predecessor. But how does it stack up against competing products? Very well, with a few exceptions. One of these is screen I/O. Office draws lots of boxes and then fills them with data. This is fine at 19,200 or 9,600 baud, but excruciating if you're dialing in with a 1,200 baud modem. Data General's CEO is much better in this respect. I would also fault Office for its sometimes confusing array of equivalent commands—one screen listed three different keystrokes to accomplish the same result. One other comparison worth making is filing: CEO automatically enforces a strict drawer:folder:document structure, whereas Office allows users to store their documents in as sloppy a fashion as they want.

Taking these factors into account, it's still clear that Office is a very strong OA product that's bound to get much better in coming months.—G.F.

**Now available
in Data General
32 bit
Business BASIC**

DIMENSION

**THE ORIGINAL
Business BASIC
APPLICATION
GENERATOR**

A fourth generation language for all Data General Systems

Don't settle for a mere program generator. DIMENSION is a complete, mature, tried and proven eight year old data base oriented application generator that works. Develop complete, sophisticated applications in weeks instead of years.

Standard features include:

- shorthand coding commands
- data dictionary
- screen builder/editor
- full function text editor
- intelligent spooler
- translator/compiler
- support utilities
- automatic documentation
- program generators (entry, maintenance, and report)
- generates Business BASIC source code program
- compatible with existing Business BASIC programs (can be intermixed)
- develops sophisticated, standardized, full function software in a fraction of the normal time
- generated application software is extremely easy to modify and maintain
- can be learned in approximately 1 day

Literally any Business BASIC application can be developed with DIMENSION. Available today for RDOS, AOS, and AOS/VS. Desktops through MV/15000.

404/799-1000



**COMMERCIAL DATA SYSTEMS
CORPORATION**

**1000 South Pioneer Drive
Smyrna (Atlanta), Georgia 30082**

Fine-tuning tradition



Inside Carnegie Hall

(Photo by Steven J. Sherman)

MV system helps orchestrate fund-raising for Carnegie Hall centennial

by Betsy Zullo • Special to Focus

Carnegie Hall hails its 98th season this year—quite a feat for a building that was almost demolished when the New York Philharmonic announced in 1959 that it was moving to a new building. Isaac Stern, famous violinist and current president of the Carnegie Hall Association, was instrumental in saving the structure and preserving what has become a cultural constant for classical music aficionados throughout the world. So, in the midst of yet another busy concert season and with the 100th anniversary still two years away, board members are busily planning the centennial celebration.

"We are booking the biggest names in classical music to perform at Carnegie

Hall during its 100th season—especially during the anniversary week," said MIS Manager Barbara Scheine.

"Those types of tickets are pretty hefty in price, usually \$1,000 and up, and to sell them we have to do special solicitations. We send out invitations to a special mailing list which is on our computer system. The subscriber and donor data base are both on the Data General," she said.

To handle special solicitations, ticketing, accounting, and fund-raising, Carnegie Hall installed in September 1987 a mirrored Data General system on two MV/15000 Model 8s. "System A handles ticketing—box office and subscription

sales—and some marketing. System B tackles fund-raising tasks," Scheine said.

The hall previously had a Wang 2200 that was used primarily for fund-raising; everything else was manual. "The amount of fund-raising we could do was limited because the system was not very sophisticated. We couldn't do any serious sorts and it was very difficult to extract information from the system. For example, we were unable to compile a list of donors who contributed more than \$1,000 within a certain time period. That would be important information to have for sending invitations to those who might purchase tickets for those expensive centennial week performances," Scheine continued.

DATA GENERAL

BUY • SELL • TRADE

SPECIAL MV2000 w/2MB 70MB Disk, Cart \$4,900

Growing pains

It soon became clear that Carnegie Hall had outgrown the Wang computer, and board members didn't waste time deciding on a new system. "When the board narrowed the choice down to two vendors (Data General and Hewlett-Packard), they called users and asked their opinion of Data General hardware and software support. Data General had a more impressive service and software support record compared to the other company," Scheine said.

Once the decision to purchase was made, the Labor Day weekend installation went off almost without a hitch. Scheine recalls, "We took a couple of storage rooms and a back stairway and converted that space into the computer room. There were a few problems in running the cables because the computer room is on the seventh floor and the box office is in the basement. But once installers figured out where the phone lines were, they ran the computer cables next to them," she said.

Calculating the savings

In addition to saving time and money, the Data General system allows the association to do many things that just weren't possible on the Wang.

"The system allows us to evaluate the number of tickets we sold at various discount prices. With a hard ticket it is difficult to tell at what price you sold the tickets unless the price was recorded when it was sold. Now we can just look up the exact number of tickets that were sold at each price. There is an enormous savings in time for our people in that they are not having to manually tally this information," Scheine said.

She continued, "We can save a lot of time when a concert is cancelled. We just pull a list of those who purchased tickets for an event, print labels, and send out cancellation notices."

A staff of five (Scheine, an assistant, and three computer operators) keeps Carnegie Hall's 80 terminals humming seven days a week, 16 hours per day. "We have no in-house programmers and use existing software as opposed to generating our own. The software vendor has done special programs that we have requested. If there is a report not being generated on the system, our software

CPU's:

MV15000 Mod 10	Call
MV10000 w/BBU	\$24,900
MV4000 w/o Mem	1,500
MV8000 9600 Series w/2MB	3,900
MV6000 w/2MB	1,900
Eclipse S/140, w/256K, 16 Slot	1,950
DT Mod 10 w/256KB 15MB Flpy	990
DT Mod 20 w/256KB 15MB Flpy	990
Nova 4/X w/256KB, 16 Slot	990

MEMORIES:

8990-D 16MB MV20/MV15 Mem	\$15,900
8871 8MB MV4/MV10 Mem	5,900
8765 2MB MV Universal Mem	1,190
8708 2MB MV8000 Mem	1,190
8687 256KB S/140 Mem	290
8656 256KB MOS Eclipse Mem	100

DISKS AND TAPES:

6236 354MB ARGUS S/S	\$7,900
6161 147MB Disk S/S	1,990
6061 192MB S/S	990
STC 1920 6250 BPI Tape S/S	2,900
6123 Micro Streamer	990
6026 800/1600 BPI Tape S/S	1,390

CRT's:

D214	\$425
Dasher D410	425
6169 Dasher D211	295
Dasher 460	445

COMMUNICATIONS:

IAC16	\$3,500
IAC8	1,700
ISC II	690
4340 AMIB	290
4342 ATI16	390
4206 MCA	450

PRINTERS:

M200 340CPS	\$690
4327 300LPM Band	1,400
6190 LP2 Enhanced	950
6194 TP2 Enhanced	950

CONTROLLERS:

Floating Pt. for S/140	\$790
25MB, 10MB, 20MB, Controllers	200
Comm Basic I/O	690
6026 800/1600BPI Controller	690



COMPUTER WHOLESALERS

MARK BRADT 3246 Marjan Drive 404-455-4542 FAX 404/457-5841 Doraville, Georgia 30340

Circle 12 on reader service card.

Our Software Makes Your Job Easier

File Finder - locate AOS/VS files by text string

menuOP - Consistent user interface for security

Pipeline - E-mail for AOS/VS compatible w/CEO

File Mover - Async file transfer program

Mate - Async terminal emulator



Concept Automation, Inc.

703/450-6000

Indiana RIG *up and running!*

DGUI (Data General Users of Indiana) is a new group that is abundant with user enthusiasm and strong with Data General support! The group's members have determined that education and networking with other DG users are their main objectives and will plan meetings with these goals in mind. So, if you are in the Indiana area and want to learn how to get the most out of your DG system or you want to make valuable contacts close to home, join the group today!

DGUI has had two meetings and is ready to start running with a full schedule for the summer! The next meeting is May 10 at 2:00 p.m. For details on location and program topics, contact either Nancy Miller at 317/253-1711, Don Haycox at 317/271-1542, Annette Kaub at 317/573-2980, or Arden Grubb at 812/934-4953.

Circle 31 on reader service card.

company will write a program so that we can do that report," Scheine said.

The software is written by two companies that work together. The ticketing system is provided by GIS Systems of Tampa, Florida, and the fund-raising software is written by Complete Computer Systems in North Philadelphia, Pennsylvania.

Performance

As far as problems with the system itself, lack of speed seems to be the major drawback. The hall has experienced significant performance problems that Scheine thinks are related to the fact that the vendor underestimated the hall's needs when configuring the system. "The original system cost \$500,000. Last year we added \$250,000 worth of equipment and this year we are tacking on another \$350,000," Scheine said.

The Carnegie Hall Association is committed to doing whatever is necessary to keep its AOS/VS system efficient and operational and doesn't plan to join the Unix bandwagon. "We have too much invested in it to change to Unix," she said.



***We have stressed
to our vendor that
we really didn't
want to go to our
board in a year
and ask for more
equipment***

"We will soon install a facilities scheduling system. The accounting right now is PC-based, but we are going to be converting that over to the Data General. Our ticketing and fund-raising system is not integrated at this stage and we are planning to have an integrated system; we now have a separate subscriber and donor base," Scheine said.

Budgeting for growth

Much like a large company, Carnegie Hall works within strict budget constraints. And since the association is non-profit, its board has to approve large ex-

Unlike more expensive CEO text retrieval software

TEXT SCOUT 2

Installs in minutes...

Runs on existing systems...

Shows immediate results...

and the demo copy is Free!



Concept Automation, Inc.

703/450-6000

Circle 14 on reader service card.

PHJF

penditures, such as the computer system. "We have stressed to our vendor that we really didn't want to go to our board in a year and ask for more equipment, and we asked them to give us a little more than we actually need. This latest upgrade is what they are recommending, although I'm hesitant to say that this is going to be it," Scheine said.

"Not everybody is on CEO right now because of the additional cost of the terminals. We can't just go ahead and order terminals. We have to get all of this approved. So a lot of the stations are PCs. The employees who do not have a Data General have a PC to do word processing," she said.

One expense that was (and is) considerable and wasn't figured into the total cost was training employees to work the system. "We couldn't afford the training for CEO that Data General offers so we had to go out and hire a consultant. I just felt that training in general was very expensive and it was a cost that was not budgeted as we were configuring the system," Scheine said.

Despite some training problems, Scheine notes that it is fairly simple to obtain specific information from the system. "If someone needs a report on how an event is doing, we can quickly show them how to go into the system and get the information they need," Scheine said. "And on the fund-raising side, it's very easy to train someone to look up a donor to see what their history is. We have 73,000 accounts on the subscription list. The system also keeps track of 51,000 donors and prospects."

Future plans

Scheine stressed how valuable the system has become to the hall's fund-raising efforts, and how those efforts will be enhanced once the integration is complete. And, although the system won't tie directly into the new 60-story office building Carnegie Hall Association is constructing, it is sure to play a key role in the hall's expansion.

For now, Scheine's job is to ensure the system is up and running every day so the employees can manage their jobs more effectively. "When I help people by showing them how to do things on the system, it gives me a lot of satisfaction. They can do their job a lot easier because of what I do," she said. Δ

SYSGEN DATA Ltd. MARKETING

Data General COMPUTERS & PERIPHERALS WORLDWIDE

MV10000 8 MB	\$31,500	MV8000 Memory 2 MB	\$750
MV8000 2 MB	2,250	COMM BASE I/O Rev 12	750
MV4000 2 MB	2,750	IAC 16 (RS 232)	3,750
MV4000 CPU 0 MB	1,750	IAC 8 (RS232)	1,500
MV4000 DC CPU w/4MB	4,960	MCP 1w/TCB	1,500
MV4000 SC CPU 2MB	Call	DG 160 MB Disk	3,000
M600 1MB, ALM 16, 6026	1,500	4433 Printer	600
6061 S/S (Earthtone FCC)	750	38 MB Disk	450
6122 S/S Earthtone S/S	750	ISC-2	1,000
6239 S/S	13,250	6026 and cabinet (Earthtone)	2,500
120 MB Drive	1,200	Exp. Chassis (MV10000)	2,250
6231 Tape Drive S/S	500	BBU (MV10000)	2,000
6311 Tape Drive	800	4327 B300	1,750
WIOC (MV10000)	4,500	4364 B600 S/S	2,850
MV 4 & 10 Memory 1 MB	500	D460	425
MV 4 & 10 Memory 2 MB	1,100	D410	400
MV 4 & 10 Memory 4 MB	3,000	D411	450

DATA GENERAL SPECIAL

DG MV4000 DC, 4 MB, IAC-16, 6311 Tape, 120 MB Disk, 4433 Printer, LQ Printer, 7-D460 Terminals \$12,500

END USER FINANCING SHORT AND LONG TERM LEASING

PRICING SUBJECT TO CHANGE WITHOUT NOTICE
QUANTITY DISCOUNTS AVAILABLE ON ALL ITEMS
ALL EQUIPMENT SOLD IS WARRANTED FOR 30 DAYS

WE ALSO DISTRIBUTE IBM PC, XT, AT, COMPAQ & PERIPHERALS

12 ELKLAND ROAD, MELVILLE, NY 11747 (516)491-1100 fax: (516)491-1559

Circle 56 on reader service card.

Now Available...

MATE Rev 1.20

Remote Log on & File Transfer
Made Easier

Improved session logging

Send big block sizes in X/Y Modem

Full ANSI 3.64 terminal emulation

and the demo copy is Free!



Concept Automation, Inc.
703/450-6000

Circle 15 on reader service card.



File transfer products

You have a choice of speed, ease-of-use, and price

(This article is the last half of a review of file transfer products. The first installment, "Transfer student: A close look at how BLAST, TEX, Softerm, and Smarterterm handle file transfers" appeared in the April 1989 issue of Focus.)

VTERM

VTERM 1.04 is a virtual terminal emulator from American Airlines' SABRE travel information arm. The program uses the XMODEM protocol, and it can be invoked in one of two ways—by pressing Ctrl-Shift-F6 while you're using its DG terminal emulator program, or as a standalone program, XMDM.PR. The standalone programs sent LOAD_II in just about 20 minutes, or better than 827 bytes/second, making VTERM the fastest of the XMODEM protocols I've tested. It's also small and unobtrusive—the 24 KB file used about 4.4 percent of the CPU. If all you're interested in is doing is fast XMODEM transfers, this is the program to get.

MATE

MATE revision 1.20 from Concept Automation, is another virtual terminal emulator that supports XMODEM. MATE's protocol is not standalone, and I could find no method in the manual for starting a transfer through command line switches. Therefore, files can't be sent automatically, but instead must be invoked from within the program by using F12 to receive and F13 to send. For those of us with 6053 terminals or who are using a PC and an emulator, this is a minor annoyance. I never use function keys 11 through 15. If I'm using something that requires them, such as DISCO, I simply ^C^B out of it. This is because function

key mapping is different in every emulator—Alt-F3 in Pereline, Alt-3 in Mirror, Shift-Tab-F3 in Smarterterm 400, etc. For this demo, I had to find my manual and look up what to use, because MATE wouldn't let me use ^C^B to terminate it.

MATE transferred files at 802 bytes/second, but used almost 9 percent of the CPU time in doing so. In last month's column, I advised not to bother with ASCII file transfers while using a direct connection. I tried it with MATE, anyway—it sent a 52 KB file in just under 18 minutes, for a top speed of 49 bytes/second. In addition, if you type "escape" to try to get out of the transfer, MATE bombs out with a stack error. Here's a case where you really don't want to do ASCII transfers!

Breakthrough

Breakthrough, from Applied Computer Solutions, is designed exclusively for file transfers—no virtual emulation or other applications. I was a little disappointed, then, when the XMODEM transfer of my file took over 28 minutes. A product designed explicitly for transfers should be able to do better than 592 bytes/second, and should use less than 10 percent of the CPU.

The first time I tried Breakthrough, I left its console line number set at 5, the default, rather than 17, which I normally use. As soon as I started the transfer, the program dropped me into AOS/VS Debug. Art Giuliani, the company's president, told me that this was to facilitate problem solving. While this may have been desirable during the development stage, I feel that it's not very friendly—and potentially dangerous—to terminate

a program by this method. I don't want anyone on my staff seeing DEBUG! I'd much rather the program terminate with a message such as "That line is already in use."

Turbotran

Turbotran rev 1.21, from Data Bank Associates, is also a file-transfer only program. It transferred my file efficiently and quickly—765 bytes per second, consuming about 5 percent of the CPU. Turbotran also offers YMODEM, which few of the other packages do.

Like TEX, Turbotran simply worked well. Turbotran, however, includes an interactive mode with a useful—if minimal—help screen. Some transfer statistics are shown before the transmission of the file. Unfortunately, these statistics are incorrect. The program gave an estimated transfer time for my file of 4 hours, 43 minutes, or more than 10 times what it actually took. I don't know if Turbotran is assuming that I'm transmitting at 1200 baud or what, but these numbers should either be corrected or removed. There's a good chance that an end-user wouldn't even try to transfer a file if he or she saw that it was going to take four hours.

The YMODEM transfer was, as expected, quicker than XMODEM. LOAD_II transferred at 860 bytes per second—better than 12 percent faster than the XMODEM transfer. In a clean line environment, I can't see any reason not to use YMODEM for all of your file transfers, and I wish other manufacturers would include the option. Chalk up a big plus for Turbotran.

If you happen to be using Smarterterm 400 as your emulator, Turbotran has the

simplest method of transferring files that I've seen. Simply typing XSEND [DG file] [PC file] transfers my file to the PC—no setting up TurboTran or Smarterm, no additional commands necessary. Typing XRECEIVE will import files. This is definitely the way to go if you have users who have problems remembering their password! It's a simple and elegant procedure that should be included in any file transfer package. In fact, I'd like to see a TurboTran macro for other terminal emulators.

VTERM rev 1.04
\$495
American Airlines
4255 Amon Carter Blvd.
Mail Drop 4360
Fort Worth, TX 76155
817/963-3435

MATE rev 1.20
\$1,000 (average)
Concept Automation
1319 Moran Rd.
Sterling, VA 22170
703/450-6000
Contact: Sue Miller

Breakthrough (RDOS 3.00, AOS/VS 3.00)
\$300
Applied Computer Solutions
2336 Union Ave.
Alamogordo, NM 88310
505/434-0206
Contact: Art Giuliani

TurboTran rev 1.21
\$225
Data Bank Associates
20010 Century Blvd., #104
Germantown, MD 20874
301/540-5562
Contact: Edward Rosen

PC/Remote
\$1,500-\$24,000
Rational Data Systems
150 South Los Robles Ave., #410
Pasadena, CA 91101
818/568-9991
Contact: Doug Kaye

PC/Remote

Finally, I took a look at PC/Remote, from Rational Data Systems. Now, calling PC/Remote a file transfer program is a little like calling an MV/40000 a word processor, but Remote does include file transfers, so I thought I'd take a look. My file transferred at 540 bytes/second in the only mode PC/Remote has—error

free—which places it at the top of the error-free transfers not using compression. Doug Kaye, the president of Rational Data, tells me that the program was designed for minimum system impact. He acknowledges that PC/Remote is not the fastest transfer utility available, but by doing such things as writing in 128-byte blocks, the IAC default, overall system performance will be optimized. My tests bear this out—CPU usage was 8 percent, the lowest impact of all of the error-free transfers. In addition, the nature of PC/Remote makes file transfers incredibly simple. To move a file from the PC to the MV, I typed PCR EXPORT AFILE:UTIL:AFILE.

Of course, PC/Remote will do much more than file transfers, but that's another story, and deserves a separate column. Suffice it to say that PC/Remote was the easiest, fastest, and least obtrusive of the error-free transfer programs that I tested.

There may be a dearth of software for Data General in some areas, but when it comes to file transfers, you just about have your choice of speed, ease of use, and price. What you should buy depends on what you need out of it, and in this case, there are plenty of alternatives.

Odds and ends department

I'm giving a provisional blessing to VS 7.64. It's been up a month, and I have my printers back, and have run into no other problems.

For a pleasant change, I know what I'm going to write about for the next few months. My next column will be the ICOBOL 1.50 column. Rev 1.50 contains all of the file changes, and requires running MINISAM_CONVERT on my files. Actually, I'd much rather wait until someone out there does it and calls me with the results—but duty calls.

The column following that will be a review of the Megatape GT/88 tape drive. If you're planning on purchasing a tape drive, *do not* do it without calling Megatape. Just to whet your appetite—how does 2 gigabytes on an 8 millimeter VCR tape sound? Δ

Tim Boyer is EDP Manager at Denman Tire Corporation. He may be reached at P.O. Box 951, Warren, OH 44482; 216/898-2711 or on the NADGUG bulletin board at 415/924-3652.

For a smoother sailing upgrade 7800 7800XP



and a better end result.....

... specify SCIP memory and IAX16's when you upgrade to an MV7800 or MV7800XP
... @ 1/2 the +5v power usage plus lower cost—the SCIP duo allows you to add more than the "limit" of IAC(X)'s in your chassis yet increases overall reliability by reducing heat. They're easy to install and are 100% DG compatible too.

- ▲ MV780/MV780X memory
4 MB, 8 MB, 10 MB sizes
enable/disable switch
lifetime warranty
- ▲ IAX16 /IAX16A
RS232 or RS422
runs all DG diagnostics
21% faster thruput

(213) 282 8700



**449 So Beverly Dr Ste 201
Beverly Hills, CA 90212**

Hot links

Termserver, ITC tame terminal connection nightmares

In a two-part article, this month and next, we'll look at something that affects terminal and PC users alike: terminal interconnection and emulation via ethernet. There's been a lot of activity in this area for the past year or so, but relatively little discussion of this new technology. New, at least, to Data General.

The Problem

Figure 1 shows the traditional way to link a terminal to an MV family computer: via an asynchronous connection to an IAC. Most terminals are connected in this manner today, but as DG central processors get larger and capable of supporting more users, the question arises, "How are we going to connect all these users to the MV?" Can you imagine an MV/4000 with over 1,000 RS-232c lines and 64 IAC-16s? Neither can I.

Figure 1: Traditional link

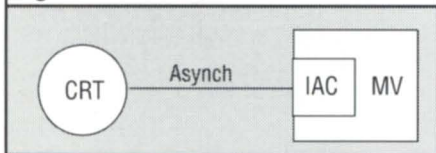

Along with this technical challenge to Data General comes a competitive one. DEC has been using ethernet as the standard method of terminal interconnection for a few years now. Whereas it is only a sophisticated DG shop that has ethernet cable installed today (typically for Xodiac), LANs such as these are common in the typical DEC shop.

Termserver: the teaser

Last year, Data General announced a gadget called the Termserver. A Termserver is sort of an ethernet-to-asynch multiplexor. It connects to the LAN, and provides 10 asynch ports for terminals, printer, etc. In the configuration shown in Figure 2 you still have lots of IACs and asynch cables, but the cables only go as far as the Termserver. From there, virtual circuits or connections are established to ports on remote Term-

ers placed elsewhere on the LAN. This configuration provides port selection, and the ability to move terminals without running new wires all the way back to the MV, but it does little to eliminate the mess behind the computer. It is also fairly expensive since each connection requires two Termserver ports (one on each end) and an IAC port.

Figure 2: Termserver

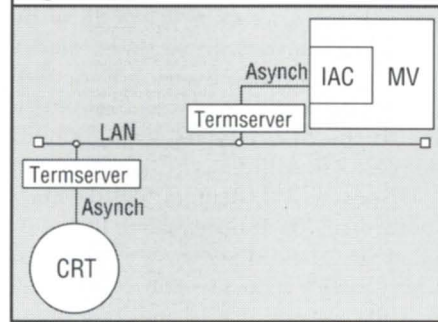

Enter the ITCs

Instead of using IAC-16s or IAC-8s in the MV family computer, there are two new controllers, the ITC-128 and the ITC-64. I hope you get a chance to see one of these things, for they are impressive pieces of hardware. Each ITC-128, for example, contains seven (yes, seven) Motorola MC68000 microprocessors. These are divided into two groups. The first group of four CPUs interfaces to the minicomputer, and with the proper download code, appears to AOS/V5 as a 128-line IAC. That's the equivalent of eight IAC-16s. The other three 68Ks communicate with the Ethernet. That's a lot of horsepower for one 15- by 15-inch controller, and it's quite well stuffed with silicon.

Think of the ITC-128 as a 128-line IAC with remote ports. (See Figure 3.) These ports are delivered in the form of Termservers connected to the ITC via an ethernet. There is no hard-wired association between a port on a Termserver and a particular ITC-128 console number. When you turn on a terminal connected to a Termserver, you are first greeted with the Termserver's command line interface. If you want to connect to a port on your MV, you will type something like "CONNECT MV". If you want to connect to a particular port, you might type "CONNECT CON82". The system manager may also preconfigure the Termserver so that a particular port on a Termserver is always connected to CON82 on the ITC-128.

Figure 3: ITC

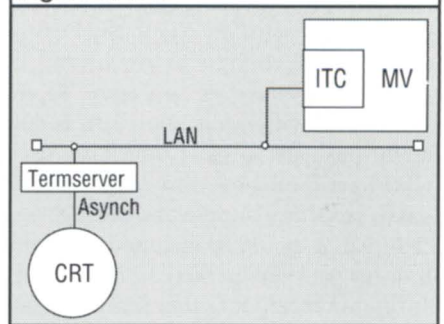

For the small format machines (MV/1500s, 2000s, and 2500s) there is a similar board called the LTC-64. This is the L-Bus Terminal Controller. It has half the capacity of its full-sized brother. We'll refer to the ITC in the rest of this article, but the comments refer to both boards.

Rotaries

The ability to name ports is made possible by an XNS protocol called Clearinghouse. Each port, either on a Termserver or on the ITC-128, can be assigned one or more names. From there, ports may be grouped into rotaries, and each rotary may have one or more names. When you attempt to connect to a rotary, you will get the next available port from that group.

Since a name may refer to either a port on an ITC or to a port on a Termserver, it is quite possible to connect from one Termserver port to another, and never use the ITC. DG sold Termserver in this configuration for many months before the ITC-128 was announced.

Figure 4: Accessing modems

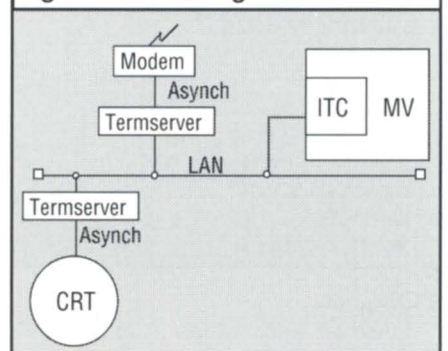

Modems

Suppose you have 100 users who would like to access modems. You have three possibilities: (1) you can buy a modem for each user, possibly connecting each of them to your PBX (ugh); (2) you can ac-

cess a pool of modems through DG/Gate (yuck); or (3) you can attach modems to Termserver ports, as shown in Figure 4. In this way you can use only five modems, say, to handle all 100 users, on the assumption that only five users will need to use a modem at any given moment.

Freedom

This is more than just port selection and a simplified cabling scheme. It also provides baud rate and parity independence. For example, your terminals may be connected at 9600 baud, but what is the baud rate of the ITC port? The answer is "it doesn't have any." Consider what happens when your terminal is connected to one of those modems on a rotary. The modem may be 2400 baud. How, then, can it communicate with your 9600 baud terminal?

Figure 5: Ethernet frame

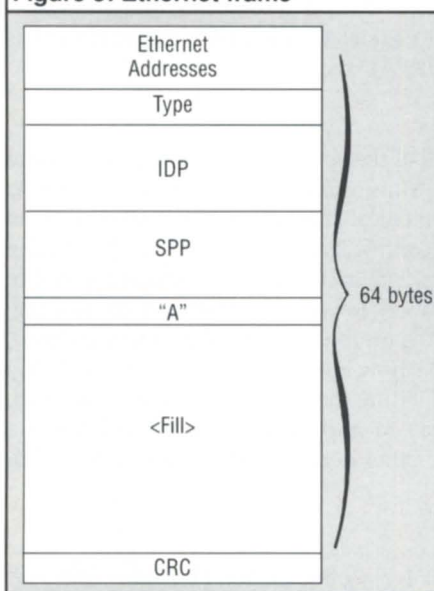

When asynch data leaves your keyboard, the parity bits are removed and the character is treated as a raw 8-bit datum. The character is then encapsulated through various layers of protocol: at the session layer, the XNS sequenced packet

protocol (SPP) is used. The SPP packet is further encapsulated into an internet datagram protocol (IDP) packet, which is finally placed into an IEEE 802.3 (ethernet) frame. (See Figure 5.)

At the other end of the connection, these layers are stripped away (de-encapsulated). If the destination is an ITC, the character is simply handed to the PMGR side of the board. It never needs to go

through the asynch process again. If, on the other hand, the destination is another Termserver port, the character is re-generated as a serial stream of bits, with start, stop, and possibly parity bits attached.

Next month we'll continue the discussion of ITCs and their performance issues, and we'll take a look at how PCs can emulate Data General terminals directly over the LAN. △

AOS/VS: WORRIED ABOUT SECURITY?

Try a Demo of: **GUARDIAN**

©DataLynx, Inc. **GUARDIAN PROFILE EDITOR** User name: DL.Husing

```

1-Password:
2-Profile expire: 12-Jul-89      3-Password life:      90
4-Initial program: :GUARD_USR.PR
5-Initial IPC file:
6-Initial directory:
7-Default user priority:      2      8-Max. queue priority: 1
                                         Extended Options-----
101-Initial user program:      :CLI.PR
102-Primary start time:        07:30      103-End time: 12:00      104-Days:      1-5
105-Secondary start time:      13:00      106-End time: 17:00      107-Days:      1-5
108-Use time windows in batch: N          109-Mins. after window to logoff: 0
110-User group number:         0          111-Force new password selection: N
112-Use GET_PASSWORD macro:    N          113-User choose own password: Y
114-Maximum concurrent logins: 0          115-Number failed logins allowed: 0

116-Consoles not allowed:
117-Other host ID#'s:
42-Comments:

Edit which field?
'Help line'...
```

1. AUTOMATIC PASSWORD CONTROL

GUARDIAN allows management to set a time limit on every user's password life. At each log-in this limit is checked. If it has expired, the user is notified of the need to change passwords within 7 days. If they do not, the profile is disabled.

2. EASY-TO-REMEMBER PASSWORD PHRASES

As users often forget random character passwords, GUARDIAN can create 250,000 5-7 letter English password phrases. New password phrases can be automatically assigned to users, or they can be given the option of creating their own.

3. SET 61 USER PRIVILEGES WITH JUST ONE SCREEN & WINDOW

GUARDIAN replaces PREDITOR with one profile editor screen. 61 privileges can be set by changing single menu items or using any existing profile as a template. XODIAC support field specifies the processors to be updated if a profile is changed.

4. CONTROLLING ACCESS BY TIME OR GROUPS

GUARDIAN can limit a user's access to specific hours and consoles, and/or assign them to 1 of 100 groups whose access and number of concurrent users can each be controlled.

5. MANAGEMENT REPORTS

GUARDIAN uses a log file to track unauthorized access attempts. Management reports show who has expired passwords or profiles, "super" class privileges, "obvious" passwords, and who has not used the system for a user-defined period of time.

DataLynx • 6659 Convoy Ct. • San Diego, CA 92111 • (619) 560-8112
Le Software Man • Box 545 • London N78DF UK • 01-809-2762
Mini-Computer Sys • 411 Hawthorn Rd. • S. Caulfield 3162 Australia • 03-528-2711

Circle 22 on reader service card.

Time out

Regaining control from the component between the keyboard and the chair

A robot developed his skill
At reading phonetically, till
He could say any word,
But the people who heard
Could tell comprehension was nil.

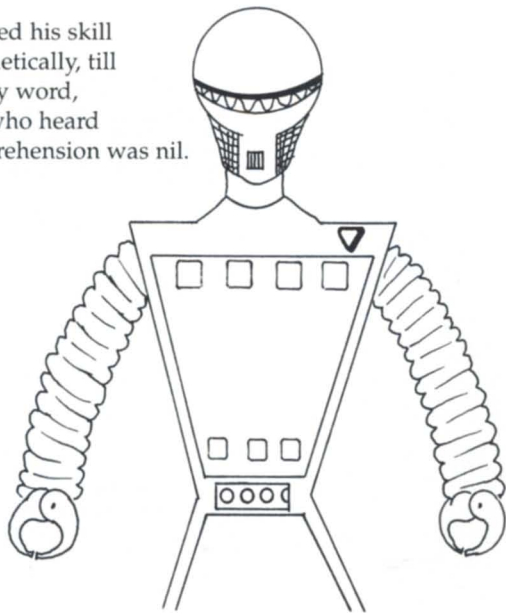

"Glorobots" by Gloria Maxson. Copyright 1975 by Technical Publishing Company, Greenwich, Connecticut. (Datamation)

by Michael Dupras • Special to Focus

If the first program you wrote was to print "Hello world," (or your name 100 times), then chances are that the second program read something from the keyboard. It is also likely that the program waited patiently for you to enter the characters while it was actually doing something else for someone else.

This article will discuss how you can get AOS/VS to do something other than wait patiently while reading your keyboard, and a little about reads in general.

?READ pending

By now, you are probably aware that a task that makes a system call will pend, or wait, for the completion of that call (after all, the computer really does only one thing at a time). On a block read or write request, your program waits until the data is returned or put somewhere safe, such as on a chain or queue. Since the time to actually move or get the data is relatively short (as we perceive it), we don't have to worry about it much.

READs from terminals, however, are another story, as it might take a person several minutes to actually press the keyboard in just the right spot, namely the NEW LINE key (or other terminator), thereby telling the IAC to send the data to the PMGR, which

sends it to your data buffer, etc. The result is that your program is not doing very much for a while. This means that it is not the program that is in control, but the user located between the keyboard and the chair.

The usual methods of reading characters from the keyboard are fixed-length (record) reads, and data-sensitive reads. As their names imply, a fixed-length read will read any and all characters until the requested number of characters has been entered, and the data-sensitive read will read characters until a terminator is entered.

Screen-edit reads are similar to data-sensitive reads, but have the added convenience of allowing some of the basic editing functions to be performed in the IAC before sending the result to the CPU.

If you don't want your program to wait for a terminating character to be entered, you could always opt for single character (binary) reads. This allows the program to get control after every keystroke, but it does have a significant performance cost of a system call for every incoming character, and the program still must wait for a key to be struck.

In an upcoming article, I would like to discuss yet another type of read, called the greedy read, that uses the screen-management extensions to the ?READ system call, and allows the program to get all of the characters that the IAC input buffer has received since the last ?READ request.

Unpending Reads

One symptom that all of the above terminal reads suffer from is that your program waits until at least one key is struck, regardless of how long it takes. There is a way, however, to allow your programs to have control at all times, and that is by making timed-out read requests. The trick is to use multitasking and to get two tasks to do the work for you: one that does the reading, and another that does the timing. If, just before doing the read, we can tell the timer task how long we want it to wait, and then if we have a method of letting the timer task interrupt the read, we are well on our way to implementing timed-out read requests. There are a few other details to worry about, but I will get to them.

Timer task

Starting the timer task is easy, but we don't want to create and destroy a separate timer task for every read request, because this would impact the performance of your system. It is much more efficient to start the timer task just once, and have it start its stopwatch only when we want it to. This can easily be accomplished by using intertask messaging through a mailbox using the ?REC and ?XMT system calls. ?XMT allows us to send a "postcard" containing a single 32-bit non-zero value to a mailbox. Conversely, ?REC is the system call that allows a task to wait at the mailbox for mail to come in. When the ?REC call "comes home" the task that issued the call continues (postcard in hand, leaving the mailbox empty).

All is well. We (the task doing the read) have started the timer task (using the ?TASK system call), which is now waiting for mail (?REC), and sent it via an ?XMT value. AOS/VS has unpended the timer task upon receipt of the mail, and it is now waiting the required time (?WDELAY). In the meantime, we are waiting for someone at the keyboard to type in the answer to

"life, the universe, and everything," followed by a NEW LINE.

What happens next? If the user has finally struck the magic delimiter, nothing is different from the previous implementation of the program—the program continues normally. If the timer expired before the read, XYZZY (nothing happens). We, the programmers, must do something to let one task tell the other that the awaited event has finished. Unfortunately, ?XMT is not the answer this time, because the other task is not waiting with a ?REC. The other task is waiting for its event to complete. Now something must wake it up from what it was doing, and force it back to reality.

Kickbacks

As described above, eventually one of the two tasks will come to life because of completion of the system call. What we have to do now is stop the other task from finishing what it was doing. If the ?READ comes home first, we want to stop the timer, and restart it at the point where it is ready to receive another message. Then the task that issued the ?READ can continue on its way. If the case was that the ?WDELAY was the first to come home, we want the timer task to redirect the task that it was reading to a point where it knows that a time-out has occurred, and let it continue from there. Meanwhile the timer task resets itself to wait for another message, and the whole thing goes on from there.

AOS/VS does provide the mechanism for giving another

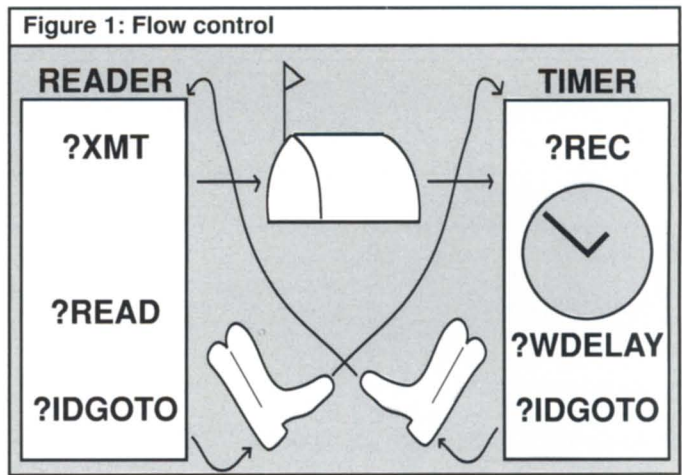

task the kick—the system call ?IDGOTO. ?IDGOTO asks AOS/VS to force a task with a specific task ID to GOTO a particular address as soon as the specified task regains control of the CPU. If both the reader task and the timer task know where to send their alter egos, then we have a way of redirecting a) the timer task to await another timer request, and b) the reading task to give up on the current read and continue.

If you refer to Figure 1, you will see two parallel threads of execution, the reader task, and the timer task. Just before issuing

JOIN FORCES

IN THE FIGHT AGAINST POOR SYSTEM PERFORMANCE!

INFOS reorganization with the VS.TOOLBOX™

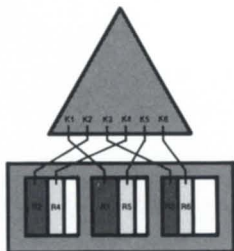

Before reorganization: Modifications have made the INFOS file disorganized. As each record is accessed, a different page must be read from disk. A large amount of I/O is required, and INFOS performance is poor.

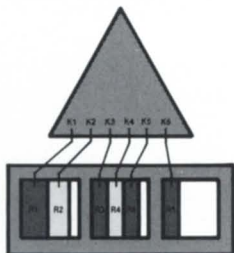

After the VS.TOOLBOX: Data records have been re-written sequentially. During sequential processing, each page must be read from disk only once. The amount of I/O is reduced, and INFOS performance is improved.

PHONE:
(913) 823-7257

EAGLE Software, Inc.

P.O. Box 16 / 169 E. Cloud
Salina, Kansas 67402-0016

VS.TOOLBOX and DISK.PAK are trademarks of EAGLE Software, Inc.

Disk reorganization with the DISK.PAK™



Before reorganization: Directory information, frequent files, and available space scattered throughout the disk. High average seek distance and poor performance.



After the DISK.PAK: Directory information and frequent files clustered on a few cylinders, available space made contiguous. Low average seek distance and improved performance.

FAX:
(913) 823-6185

Circle 27 on reader service card.

Figure 2: Sample program

```
#nolist
#include <paru.h>
#include <stdio.h>
#include <multitask.h>
#include <setjmp.h>
#include <packets:task.h>
#list

#define BROADCAST -1
#define FOR_YOUR_EYES_ONLY 0

#define TIMER_TASK_ID 10
#define TIMER_TASK_PRIORITY 1
#define TIMER_TASK_STACK_SIZE 3000

int ac0, ac1, ac2, *rac0, *rac1, *rac2, sys_error;

jmp_buf reader_label, timer_label;
int read_timeout_mailbox;
int main_task_id, main_task_priority;
int read_time_out_ms;

void read_timer()
{
    int sleep_time_ms, rtsys_error;
```

```
/* setup where we want to be jumped to */
setjmp ( timer_label );
for ( ;; ) /* forever */
{
    if ( rtsys_error = sys_rec( &read_timeout_mailbox,
                               &sleep_time_ms )
        /* your system call error processing goes here */
        /* now delay for so many milliseconds */
        sys_wdelay ( sleep_time_ms );
        /* wake up the read task & tear down the read request */
        mlongjmp ( main_task_id, reader_label, 1 );
    } /* end of forever */
} /* end of read_timer task.. surprise, surprise!!
a task looks just like a normal function */

main(argc,argv)
int argc;
char *argv[];
{
    /* get our task id,
       we need it so that the timer can kick back */
    if( sys_error = sys_mytid( & main_task_id,
                              & main_task_priority))
        /* your system call error processing goes here */
    /* start our timer task now so it gets a chance to
       init before we need it */
```

K&M Computers

Sell • Buy • Lease

(516) 232-2530

FAX (516) 232-2709

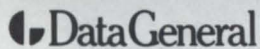

Give us a call for all your DG needs—
from the Desktop 10 to the MV/20000.
Full line of DG terminals—new and used.
Discounted.

*** SPECIAL ***
MV/8000 with 2MB, AT16, 192MB
S/S, 6026 S/S, 2-D450's, 2230 S/S \$5,500

77-10 Allwood Avenue
Central Islip, NY 11722

Circle 38 on reader service card.

Ki RESEARCH

1 800 Ki4 8352

[603 888-0304]

Network Management Tools for AOS/VS

Test your ILC or LLC while AOS/VS is still running!

LANDIAG

While your AOS/VS system is operational:

- You can run diagnostics on your ILC or LLC
- You can test your transceiver after installing it
- You can check your ethernet cable for opens and shorts with the ILC and LLC's on-board TDR

Avoid the high cost of protocol analyzers

DEPICT

- You can capture network packets using your AOS/VS system connected to the ethernet
- You can then display these packets in a clear understandable text
- Supported protocols include TCP/IP, DECnet, LAT
- Your custom application protocols can easily be included by contacting Ki Research

Circle 37 on reader service card.

```

if ( mtask ( read_timer,
            TIMER_TASK_STACK_SIZE, TIMER_TASK_ID,
            TIMER_TASK_PRIORITY ) )
    { /* your system call error processing goes here */ }

/* prepare for us to be redirected upon demand */
setjmp ( reader_label ); /* return here when redirected */
for(;;) /* forever */
{ /* tell our timer task that we are about to do a read.
   should the timer task timeout, it will kick us
   back to the setjmp statement above, else we loop
   in this forever loop */

    if ( sys_error = sys_xmt( &read_timeout_mailbox,
                            read_time_out_ms,
                            FOR_YOUR_EYES_ONLY ) )
        /* check if mailbox already has something in it */
        if (sys_error != ERXMT /* mailbox has something in it */
            { /* your system call error handling goes here */ }
        /* issue the read — it MIGHT NOT come home!! */
        /* your code for doing any type of reads goes here. . . */

        /* kick the timer so that it restarts */

        mlongjmp ( TIMER_TASK_ID, timer_label, 2 );
    } /* end of forever */
} /* end of main program */

```

the read request, the timer task will send a message via ?XMT to the mailbox. Upon receipt of the mail, the timer task uses the value on the postcard to delay for that many milliseconds. In both threads, execution will pend until their respective system calls "come home" (?READ or ?WDELAY). Upon completion of either system call, the task that completed first will force the other to a known point.

Time-out

At this point, you will have successfully implemented a timed-out read request (or any other type of operation that you want to put an alarm clock on).

For "C" programmers, I am enclosing an added bonus. Figure 2 contains a skeleton program that shows how to implement all of the details that were discussed. This is actually a fragment of a program that I have used. Please note that setting up the label and doing the ?IDGOTO were actually implemented using the setjmp() and mlongjmp() function calls available with "C," but they could be coded in any language that allows you to get and save the logical address of the current location, and perform a system call. Δ

Michael Dupras is senior consultant for the Software Products and Services Division of DG Canada. He may be reached at Data General, 1827 Woodward Dr., Ottawa, Ontario, Canada K2C 0P9.

"YOU NEED DATA GENERAL EQUIPMENT. YOU NEED IT NOW. YOU NEED IT PRICED RIGHT. AND IT HAS TO MEET YOUR SPECIFICATIONS."



Whether you want to upgrade or expand your Data General system, Security Computer Sales is "The Solution". We are recognized as one of the largest volume dealers in new and used Data General systems and components. That's why we can custom-configure the exact system you need, to YOUR specifications. And whether you need a complete system or just a cable, we make every effort to assure your equipment is delivered when you need it.

Just tell us what you need. Complete systems, CPU's, Controllers, Printers, Drives, Terminals, Memory, and Communications. MV's, S/280's, Nova's and Desktops. We have them all. And when you order from us, your system comes complete — down to the last nut, bolt and cable! What is more, before you get it, we completely clean, fully test — and if necessary, totally recondition — every item we sell.



Security Computer Sales is known for its great deals. You just can't get better price/performance. Our prices are all negotiable and open to bids too. And, we give you an additional discount on all cash purchases. We're buying too, and we pay top dollar. When it comes to the best prices, we are "The Solution".

We guarantee every piece of equipment we deliver to be complete, fully operational, and eligible for servicing by the maintenance company of your choice. And, we offer depot repair, on-site field service maintenance, and guaranteed uptime maintenance on remote sites — all for far less than standard DG prices!

We Are "The Solution" For All Of Your Data General Equipment Needs

We offer the best deals and the best price/performance in new and used Data General systems and equipment. Why wait any longer? Call "The Solution" today. Discover the Security Computer Sales difference for yourself!



"THE SOLUTION"

**Security Computer Sales, Inc., 622 Rossmor Building
500 North Robert Street, St. Paul, MN 55101**

PHONE: (612) 227-5683 or FAX: (612) 223-5524

Circle 52 on reader service card.



Don't duplicate. Instantiate!

Good code only needs to appear once

It never ceases to amaze me how disorganized and inefficient some people are with the management of their software projects. The most obvious example is duplicate code scattered all over the disk. Good code only needs to appear once in the universe. However, since all existing systems aren't interconnected (yet), this

Figure 1: A simple algorithm

```
subroutine SWAP(var1,var2)
implicit none
integer var1,var2,temp
temp=var1
var1=var2
var2=temp
return
end
```

limits the definition of "universe" to a single system.

I have often seen groups of several subroutines containing almost identical code—only the subroutine name and one or two lines of code are actually different. Everybody knows rule number 1: create a subroutine or procedure rather than duplicate code. Having done that, don't stop there. If you have to change the algorithm slightly for a different case, don't copy the subroutine; modify the algorithm and add an option or two to the calling

sequence. Finally, if another version of the procedure is required for a different variable type (using the same algorithm), use a technique called instantiation.

The Ada language has the capability of defining generic procedures and then declaring their types by instantiation at compile time. The algorithm is coded using generic variable types and an instance of the algorithm is created for each required variable type. As far as I know,

Figure 2: Three versions of "SWAP"

```
subroutine SWAP_INT(var1,var2)
implicit none
INTEGER var1,var2,temp
include "SWAP.GENERIC"

subroutine SWAP_REAL(var1,var2)
implicit none
REAL var1,var2,temp
include "SWAP.GENERIC"

subroutine SWAP_CHAR(var1,var2)
implicit none
CHARACTER(*) var1,var2
CHARACTER*256 temp
if(len(var1).gt.len(temp)) then
  stop 'Panic: SWAP_CHAR var1'
end if
if(len(var2).gt.len(temp)) then
  stop 'Panic: SWAP_CHAR var2'
```

no other language allows that, but the idea can be implemented reasonably well in Fortran and other languages using the "INCLUDE" statement.

Figure 1 shows a subroutine to switch the values of two integers. Despite its simplicity, the procedure can not be used

with real or character entities. Rather than make three copies of the entire subroutine and change the declarations, Figure 2 shows how to create a subroutine for each different data type, keeping the algorithm separate in a "generic" file (Figure 3). The algorithm is coded for an unspecified variable type.

For the SWAP_CHAR subroutine, some assumption must be made about the maximum length of the character arguments: although 32,767 is the maximum

Figure 3: File "SWAP.GENERIC"

```
temp=var1
var1=var2
var2=temp
return
end
```

length of a character entity, 256 is sufficient for all filenames and pathnames. To avoid surprises, SWAP_CHAR has two extra lines of code to check the lengths of the arguments.

Although the algorithm used here is trivial, the concept can be extended to complex algorithms. One of the best uses for instantiation is for sorting algorithms or other complex computation functions. Remember, the algorithm should only appear once! Δ

John A. Grant is a geophysicist with the Geological Survey of Canada. He is also system manager, chief cook, and bottle washer for the Exploration Geophysics Subdivision's MV/4000. He may be contacted at 601 Booth St, Room 591, Ottawa, Ontario, K1A 0E8: 613/992-1082.

YOU DEMAND, WE SUPPLY.

When you're in the market for Data General equipment, call Data Investors to supply the equipment to meet your demands. As an international supplier of pre-owned equipment, we make it our policy to stock every possible model. We are constantly adding to our stock. Every machine is tested prior to shipment, and each one is guaranteed to be eligible for Data General maintenance. When you're looking to buy or sell DG equipment, call the people who understand supply and demand. Call Data Investors.

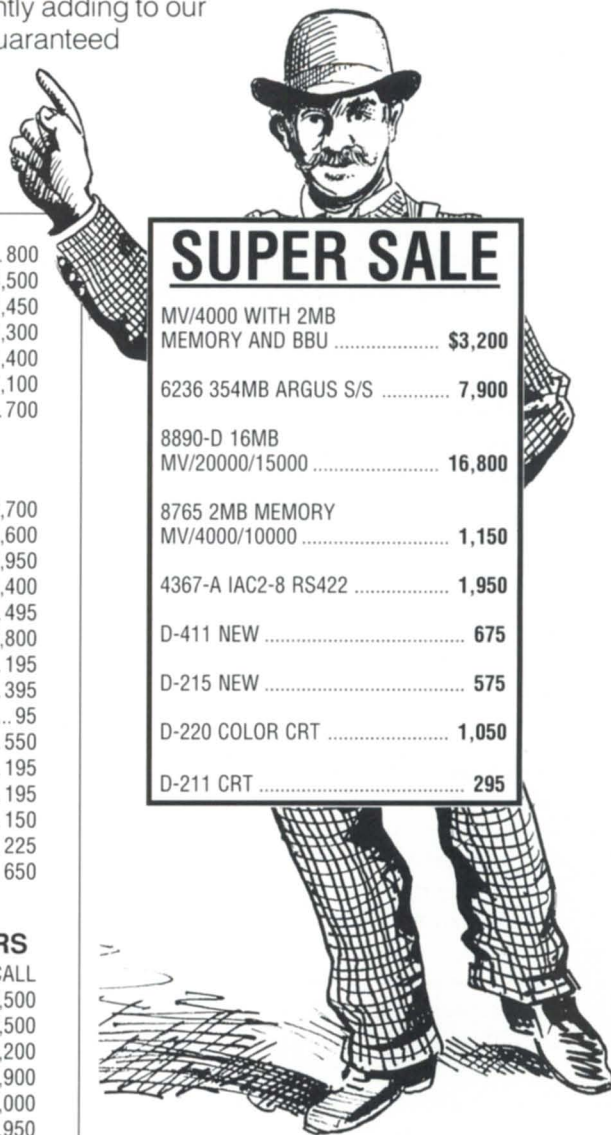

SUPER SALE	
MV/4000 WITH 2MB MEMORY AND BBU	\$3,200
6236 354MB ARGUS S/S	7,900
8890-D 16MB MV/20000/15000	16,800
8765 2MB MEMORY MV/4000/10000	1,150
4367-A IAC2-8 RS422	1,950
D-411 NEW	675
D-215 NEW	575
D-220 COLOR CRT	1,050
D-211 CRT	295

MEMORIES

8890-D 16MB MV/20000/15000	\$16,800
8871 8MB MV/4000/10000	6,900
8870 4MB MV/4000/10000	4,100
8765 2MB MV/4000/10000	1,150
8708 2MB MV/8000/6000	1,100
8754 512KB S/140	750
8687 256KB S/140	350
8387 256KB NOVA/4	350
8656 256KB ECLIPSE	295
DESKTOP MOD 20 512KB	450
DESKTOP MOD 10 512KB	650

TERMINALS & PRINTERS

D-216, D412, D462	CALL
D-214, D-215, D-411, D-461, D-470C	CALL
D-210, D-211, D-410, D-460, USED	CALL
4364 600 BAND D.C. S/S	\$4,900
4327 300 BAND D.C. S/S	2,700
4215 600 LPM D.C. S/S	2,500
6216 180 CPS	1,400
6190 180 CPS LP-2	495
6193 TP-2 BROWN	650
6262 DESKTOP COLOR CRT S/S	900
4221 DESKTOP PRINT CONTROLLER	400
005-8096 D.C. PRINT CONTROLLER	850
OKIDATA PRINTERS NEW	CALL

DISK DRIVES & MAG TAPES

6239 592MB ARGUS S/S	\$15,200
6236 354 MB ARGUS S/S	7,900
6161 147MB WINCHESTER S/S	2,450
6160 73MB WINCHESTER S/S	1,800
6234 50MB WINCHESTER S/S	1,400
6122 277MB DISK S/S	1,750
6061 192MB DISK S/S	1,300
6060 96MB DISK S/S	950
6070 20MB DISK S/S	800
6045 10MB DISK S/S	800
6100 25MB WINCHESTER W/1.28	1,200

6103 25MB WINCHESTER	800
6300 1600/6256 MAG TAPE S/S	18,500
6026 DUAL MAG TAPE S/S BROWN	2,450
6026 DUAL MAG TAPE S/S BLUE	1,300
6123 MICRO STREAMER BROWN	2,400
6270 DESKTOP CARTRIDGE TAPE	1,100
6125 STREAMER MAG TAPE S/S	700

COMMUNICATIONS

4360 IAC-16 RS232	\$3,700
4367 IAC-8 RS232	1,600
4367-A IAC2-8 RS422	1,950
4380 ISC-2	1,400
4342 ATI-16	495
4543-B MCP-1	2,800
4340 AMI-8	195
4257 ALM-16	395
4255 ALM-8	95
4463ZT USAM-4 DESKTOP	550
4254 DCU-200	195
4250 DCU-50	195
4241 ULM-5 4-LINES ASYNC	150
4243 ULM-5 4-LINES WITH SYNC	225
4206 MCA	650

SYSTEMS & PROCESSORS

8780 MV/10000	CALL
8888 MV/7800XP 4MB	\$14,500
8790 MV/8000 MOD-2 4MB	12,500
8760 MV/4000 2MB	3,200
9600 MV/8000 2MB	2,900
8770 S/280 2MB W/BMC	9,000
8633 C/350 2MB	2,950
8678N S/140 254KB	1,150
8622V C/150 1MB	1,900
8395N NOVA 4X 256B 16 SLOT	850
DESKTOP MOD 10 384KB 15MB	1,350
DESKTOP MOD 20 768KB 15MB	2,100
S/20 MICROECLIPSE 512KB FCC	750

CALL FOR OTHER UNLISTED EQUIPMENT ON SALE

DATA INVESTORS CORPORATION

6 West 18th Street
New York, NY 10011

(212) 675-1000

FAX # (212) 645-4539

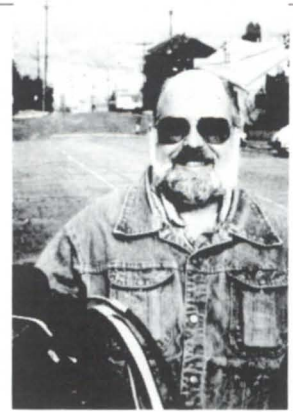

If it ain't broke, don't fix it

Diagnosing SEPAC's priority scheme

:PRIORITIES:REVISITED

Just after I wrote last month's column about setting process priorities under AOS/VS, one of the clients involved in a recent tune-up located the document that had been used to set his priorities and sent me a copy. It turns out that the source was Data General's Systems Evaluation and Performance Analysis Center (SEPAC).

Figure 1 is a summary of what the SEPAC document recommended for process priorities, compared with both the default settings and my scheme from last month. There is no indication in the documents I received of what SEPAC's goals were. Presumably, the goal is best average response time, although I can't see how anyone except CEO and network users would enjoy the fruits of this setup. Also bear in mind that this list is in descending order of priority as recommended by SEPAC. Let's take a look at this complicated 15-level priority scheme and see if we can make any sense out of it.

Under all three schemes PMGR is the highest priority process. Applying the rule of "If it ain't broke, don't fix it" makes me wonder what they have in mind when they recommend raising PMGR's priority to 1. My scheme leaves it alone.

SEPAC recommends setting the master console to the second highest priority. It's not clear what this accomplishes, other than allowing the master console to terminate a runaway lower priority process. Unfortunately, this recommendation has

a nasty side effect: you would have to declare the master console off limits, because if you used it for anything that would consume a burst of CPU (like an F/AS/S or DUMP_II/LOAD_II), you would shut out everything except PMGR for the duration. Note that under my scheme it is still possible for PID 2, by virtue of its "interactiveness" relative to the runaway process, to terminate any runaway process except for PMGR, XTS, and XLPT. When's the last time you had to terminate a runaway PMGR, XTS, or XLPT? Me neither.

SEPAC level 3 includes only XTS. The default and B.J.Inc. schemes afford the same priority to XTS and PMGR. Does SEPAC know of some problem caused by this situation that the XTS development group isn't aware of and that SEPAC hasn't taken the time to STR? I think not.

SEPAC level 4 includes only EXEC. Apparently users attempting to log on (boo) and off (hooray) or users doing Q commands are judged more worthy than data base servers, network servers, CEO servers, and currently logged on users. How does that compute?

When my system is pegged, the last thing I want to encourage is more logons.

SEPAC levels 5 through 13 seem to favor global data base servers over CEO global servers. Does this mean that data base servers and their customers are more "worthy" than CEO and the network global servers? As I stated last month, one class of users should not be able to leapfrog their assigned priority simply because they make use of a global server that other users don't.

SEPAC level 14 finally accords some CPU time to users who aren't currently using one of the privileged global servers.

Figure 1: Comparison of recommended priorities

<u>Process</u>	<u>Default</u>	<u>B.J.Inc.</u>	<u>SEPAC</u>
PMGR	RES 2	RES 2	RES 1
CLI	SWAP 1	SWAP 2	SWAP 4
XTS	RES 2	RES 2	RES 10
EXEC	SWAP 2	SWAP 2	SWAP 20
INFOS	SWAP 2	SWAP 2	SWAP 25
DBMS	SWAP 2	SWAP 2	SWAP 25
SQL	SWAP 2	SWAP 2	SWAP 25
CEO_OP	SWAP 2	SWAP 2	SWAP 28
NSA	SWAP 2	SWAP 2	SWAP 30
NETOP	SWAP 2	SWAP 2	SWAP 35
MTA	SWAP 2	SWAP 2	SWAP 40
FSA	SWAP 2	SWAP 2	SWAP 50
POA	SWAP 2	SWAP 2	SWAP 50
CEO_LOG	SWAP 2	SWAP 2	SWAP 50
CSA	SWAP 2	SWAP 2	SWAP 60
RMA	SWAP 2	SWAP 2	SWAP 80
SVTA	SWAP 2	SWAP 2	SWAP 90
FTA	SWAP 2	SWAP 2	SWAP 100
Users	SWAP 2	SWAP 2	SWAP 2
FORMATTERS	SWAP 2	SWAP 2	SWAP 3
XLPT	SWAP 2	SWAP 1	SWAP 3
Batch	<u>SWAP 2</u>	<u>SWAP 259-511</u>	<u>?</u>
Total Levels:	3	4	15

The original SEPAC document shows PID 2's default priority as SWAPPABLE 2. That's not correct; it's actually SWAPPABLE 1 as I've shown.

Gilt-Edge Security: Memory from Dataram

Dataram's MV Upgrade Plan Can Save Enough to Buy Your Next DG Processor

Boost MV/15000 and MV/20000 performance with quality memory, solid support, at lower cost.

The new DR-1520 Gilt-Edge memory boards offer the reliability and performance you expect from Dataram, the DG memory leader right from the start. Yet an investment in these boards could save enough to pay for your next Data General processor!

Enhanced performance, assured growth

Add users, speed, applications today — just plug in fast Dataram memory to improve performance. As your needs grow, upgrade again. Trade in your DR-1520 — or your original DG board — for credit on a higher-capacity DR-1520. Grow from 8 to 16 or even 32 MB. The added capacity won't take up another processor slot. Your investment in memory and processor is protected.

No-risk security: support and service

A lifetime warranty assures you of memory reliability. We back that warranty with an Express Spares Program. Since Dataram boards conform to the high quality standards of DG computers, their use won't affect your DG service contract. And you can contract for third-party service. But don't expect to need it.

Multi-board dividend

Buy memory boards for *any* MV processor and earn quantity discounts, good for three years. The more power

you add, the greater the savings. If you've invested in a Dataram DG board in the last twelve months, you've already earned the discount.

Options and futures

Dataram Gilt-Edge memory boards are available for the whole family of Data General MV-series processors. We plan to support new processors as they appear, to the MV/99000 and beyond.

For information on any of our DG products, write or call today. Or circle the reader service number for full details on the DR-1520 line.

DATARAM

Dataram Corporation
P.O. Box 7528
Princeton, NJ 08543-7528
800-822-0071 • NJ 609-799-0071
TWX 510-685-2542

Dataram (Europe)
Dolly's Cottage
Dedmere Road
Marlow, Bucks, England SL71PD
Tel: (06284) 74815 • TLX: 846272

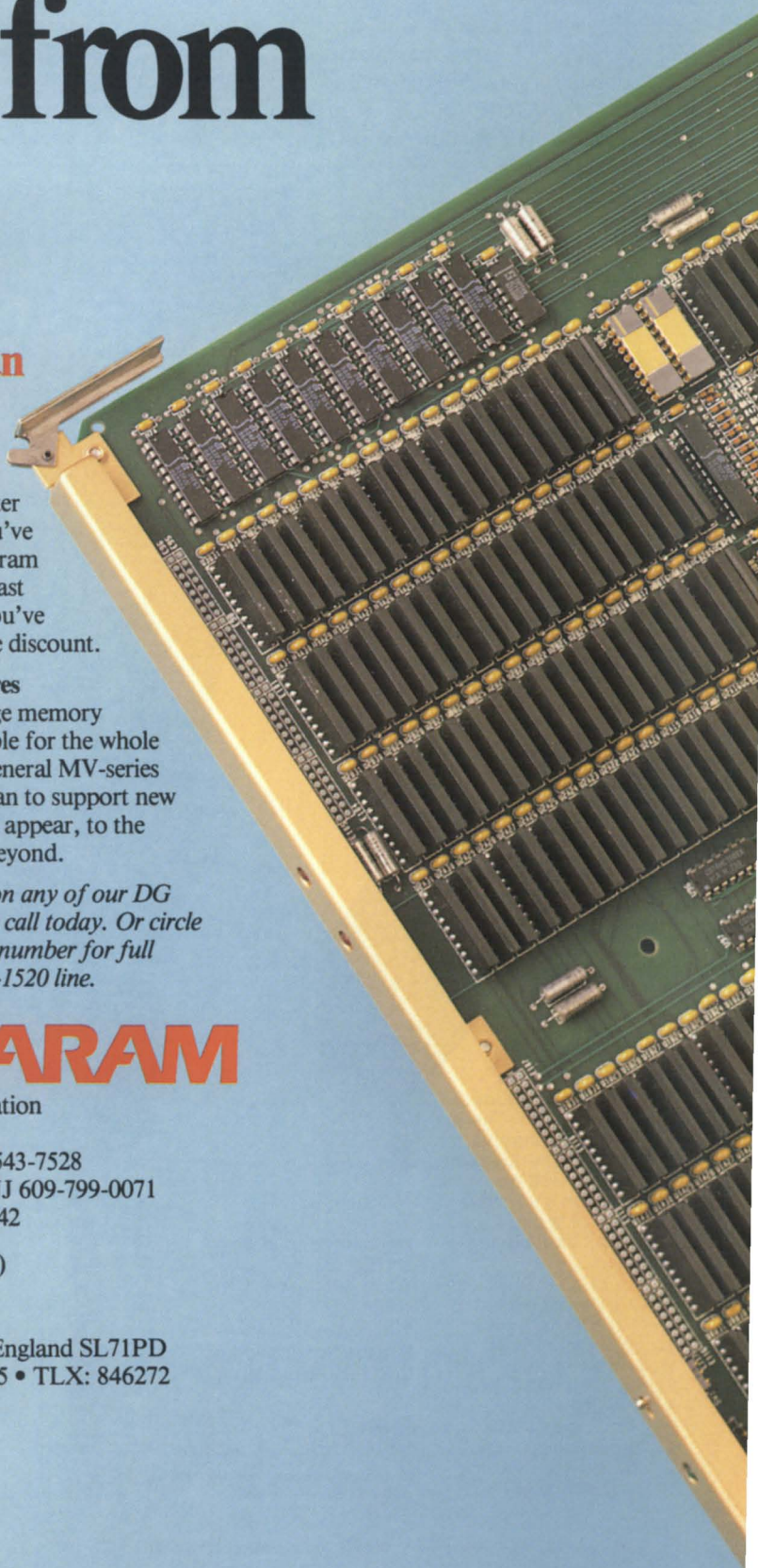

Luckily, none of the processes at levels 1-13 are capable of sustained bursts of heavy CPU consumption individually or as a group. Or are they? My scheme doesn't take that chance.

SEPAC level 15 includes XLPT and the CEO_FORMATTER sons spawned by the CEO global servers. SEPAC makes no mention of BATCH, but presumably CEO_FORMATTER qualifies as BATCH.

I think that whether CEO_FORMATTER is run higher or lower than BATCH is a decision best left up to the discretion of the system manager. Unless the CPU is massively oversubscribed most of the day, in which case the real solution is an upgrade, I'd leave the formatters sharing SWAPPABLE 2 with the users. AOS/VS will lower their priority based on their behavior (CPU intensive), and they will

have minimal impact on well-behaving interactive users.

My strategy for BATCH is to use some combination of Group III priority levels—and perhaps class scheduling—that will be appropriate for the turnaround time goals on that particular job. The idea behind using Group III is to minimize the effect of batch job system calls on Group II processes, bearing in mind that system call processing for Group II processes is performed at a priority above that used for Group III system call processing.

Putting XLPT—a relatively well-behaved process CPU-wise—below all other processes except for formatters and batch ensures that all printing will cease during periods when you have no idle CPU. Not only that, but printing to unbuffered printers (like that big, expensive 1200 lpm LPB in the computer room) will grow increasingly erratic as idle CPU drops below 25 percent, even momentarily.

Almost all of these complications in the SEPAC scheme could be forgiven if you invoke the argument that global servers are typically economical CPU consumers. However, the XLPT recommendation indicates a fundamental misunderstanding of the trade-off between economical, but time-critical, CPU consumers and normal users and their global servers.

Here's an example to illustrate how this non-intuitive trade-off works. Suppose your interactive users and global servers are demanding 100 percent of the CPU and XLPT is demanding 10 percent.

Using SEPAC's recommendations, XLPT would get 0 percent, printing would cease, and interactive users would feel no impact.

Using the default priorities, XLPT would get somewhere between 0 percent and 10 percent depending on its behavior. Printing would be erratic, and interactive users and global servers would slow down by somewhere between 0 percent and 10 percent (barely noticeable, and only interactive processes behaving more poorly than XLPT would be impacted).

Using the B.J., Inc. scheme, XLPT would get the full 10 percent continuously, printing would go full blast, and all interactive users would theoretically slow down by a full 10 percent. I say "theoretically" because XLPT's CPU consumption is so bursty that there would still be plenty of time to schedule the



Results

3CI InFoCen[®] RDBMS/4GL

"InFoCen is our most significant, competitive weapon..."

Lori A. Pickett

Lori Pickett
Director of MIS
Associated Travel
Services, Inc.

3CI InFoCen[®]
Compatible with Vax-VMS, DG-AOS/VS,
DPS-GCOS8, CDC-VSOS. 2057 Vermont Drive, Fort Collins, CO 80525

The travel industry is very competitive. Information is required on a timely basis. There isn't time for lengthy application development schedules. Getting results from a software investment is more important than buying a name.

InFoCen emphasizes rapid application development through a number of sophisticated tools including MACRO 4GL, FORMS, Report Writer and a comprehensive library which can interface to virtually all 3GL's including ADA.

When you're looking for the best RDBMS/4GL,

you want top performance and total, on-going support. When you're asked why this is important, the answer is—RESULTS.

**See the Results today.
Call 1-800-525-2001**

3CI InFoCen[®]

Compatible with Vax-VMS, DG-AOS/VS,
DPS-GCOS8, CDC-VSOS.

2057 Vermont Drive, Fort Collins, CO 80525

Circle 59 on reader service card.

well-behaving interactive processes between XLPT CPU bursts. Most of the slowdown, albeit only 10 percent, would be felt by the interactive processes that were in the process of a CPU burst themselves. Big deal.

The SEPAC priority scheme has one last pernicious side effect; it can cause unnecessary memory contention on systems that are not memory rich. When AOS/VS runs short of memory, it attempts to steal some from another process of *equal* or *lower* priority than the one that needs the memory. The SEPAC scheme effectively protects the global servers from giving up any pages, no matter how infrequently they are used, in order to benefit user processes during a memory crunch. A frequent beneficial side effect of using my scheme is that enough memory is stolen from inactive global servers (e.g., FTA) during the first bout of memory contention to keep the memory situation under control for the rest of the day.

:AVIION

I attended the press conference announcing the new Aviion series of systems based on the Motorola 88000 chip set (according to one flack at the conference, the name Aviion is really just a rearrangement of the letters in Nova II).

An 8 MB, 17 MIPS system running DG/UX for about \$7,500 is pretty scary. The scary part is not that the system is from DG—it's simply the new face it puts on the world of computing. A "real" computer system running an "almost real" operating system for slightly more than the price of a 386 running MS-DOS is enough to make a guy get religion. Well, almost enough.

According to DG, it only took nine months to develop Aviion. That means that within the next 12 months, everybody and his brother are going to be shipping 20 MIPS or better systems for the price of a PC-AT.

Given that DG announced that it is making its "commercial grade" multiprocessor version of Unix available for licensing to other members of the 88Open consortium, you've got to wonder what DG's market differentiation is going to be once the Radio Shack Christmas catalog starts featuring an 88000-based system that adheres to the Binary Compatibility Standard adopted by

88Open. Is it going to be service? Possibly. Is it going to be price? Possibly . . . but what happens when the Far East vendors flood the market with cheap clones, as seems inevitable? Is it going to be ports of proprietary software packages such as CEO? Maybe, but that flies in the face of the whole issue of portability, interchangeability, and shrink-wrap software.

Well, I guess the only thing we can do is wait and watch.

:UNIFORM:IMPRESSIONS

The DG announcement of Aviion was made the night before the opening of the Uniform Conference, a confab of several thousand Unix freaks from all over the solar system. I should have set up a pocket protector concession outside of Moscone

612_{MB}

for just \$8,900

It's hard to choose the best feature of Indocomp's new IS-4210 disk storage subsystem. At 612MB, it gives you nearly twice the additional capacity of other subsystems, yet it costs a lot less. And it lets you interface your L-bus-based DG computer (MV/2500, MV/2000, MV/1400, or DS/7500) with as many as 7 peripherals.

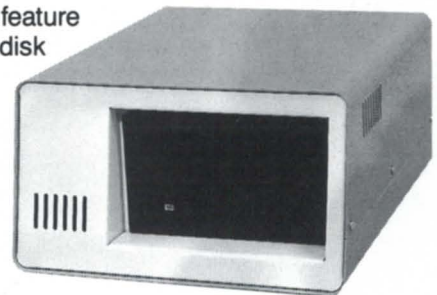

The 612MB disk—a Control Data WREN V—is just the beginning. The IS-4210 has a powerful IS-4200 SCSI controller, an AOS/VS-compatible driver, and a sturdy, compact, desktop enclosure. Cable and power supply are included.

The IS-4210 storage subsystem gives you the most capacity for the least money. . . and it's available now. Call Indocomp or your Indocomp distributor today. (Also ask about other products to help you get the most from your DG computer, like the IS-3200 VME adapter, the IS-4100 intelligent I/O controller, and the IND-68000 intelligent I/O frontend.)

INDOCOMP SYSTEMS, INC.

P.O. Box 157 • Drayton Plains, MI 48020 • (313) 666-9715 • FAX (313) 666-1001.

Circle 32 on reader service card.

FREE SHIPPING

(Up To \$100 Worth)

When
you order \$1,000
worth of equipment

from McIntyre's incredible stock of expertly reconditioned Data General products. If Data General makes it - or ever did - chances are McIntyre's has it in stock, tested, warranted, and ready to ship - FREE.

Give us a call right now for all the details.

**Rock Solid Second Source
Huge Stock Of DG Equipment
Fully Reconditioned & Warranted
Famous For Fast, Reliable Delivery
Professionally Staffed Service Depot**



mcintyre's

Mini-Computer
Sales Group Inc.

DATARAM

AUTHORIZED DISTRIBUTOR

Circle 41 on reader service card.

(313) 524-4900

FAX: (313) 524-4970

575 E. Big Beaver, Troy, Michigan 48083-1301

Center. I would have made a bundle.

A scan of the conference brochure a few months ago showed two sessions of interest, so for the first time I signed up for a Unix conference.

Walking around the massive exhibit area, I was struck by two things. First, the quality of the displays was on a par with major conferences such as Comdex and NCC. Second, the products being offered were more reminiscent of a PC swap meet.

In retrospect, I think that the main value of the conference for me was a chance to swap lies and get drunk with the largest collection of ex-DG employees gathered in one spot since the infamous DG Birthday Party in Boston last year. However, for those of you who think there might be some Unix in your future, I'll report on the two sessions I attended.

:UNIFORM:LICENSING

This was probably the most interesting conference session I've attended in quite a while, but that's probably because I also run a software sales operation. It also helped that for the last couple of years I've been sitting on a much-restarted column about software licensing and pricing strategies, but never had the guts to publish it.

The advent of networks of workstations sharing files and programs has complicated the licensing problem tremendously. Luckily, the Uniform Networking Working Group has attacked the problem head-on and issued a challenge in the form of a portable standard for handling licensing on networked systems. Because a system with only one CPU is simply a network where n=1, the standard is equally applicable to standalone AOS/VS systems.

For our part ("our" being my software operation, :SYSMGR), we plan to switch to a standard-conforming licensing scheme as soon as possible. The standard allows for both license brokering (control of the number of concurrently executing copies of the licensed program) and usage metering (pay-per-play). The standard frowns on tying a license to a particular piece of hardware (like a processor or node ID number).

This means that there's finally a chance that software vendors can get rid of the ridiculous scheme of pricing software according to the processor speed (or worse

yet, claimed speed) as a means of inferring value, usage, and support costs. In the case of DG, this would mean the end of classifying the switch from an MV/4000 DC to an MV/4000 as an "upgrade" for software licensing purposes.

Hallelujah!

:UNIFORM:PERFORMANCE

I attended the only presentation on Unix

system performance at the conference, a lame panel discussion (n=3, counting the chair) by a couple of college professors who are members of Performance Measurement Group, Inc. (PMG).

For those of you who aren't familiar with PMG, it's a group of rabid mathematical types who have struggled for nearly 25 years to collect one digit, or less, significant data and then use various

Now available in Data General 32 bit Business BASIC

**STATE-OF-THE-ART SOFTWARE PACKAGES
FOR DASHER / 286 THRU MV-15000**

- Order processing/Billing • Payroll • Inventory Control • Purchasing • Sales Analysis • Fixed Assets
- Accounts Receivable/Payable • General Ledger • Word Processing • Electronic Spreadsheet

DATA GENERAL HARDWARE

<ul style="list-style-type: none"> • COMPLETE SYSTEMS • PERIPHERALS • NEW OR REFURBISHED EQUIPMENT 	<ul style="list-style-type: none"> • UPGRADES • SYSTEM TRADE-INS • MODEMS, CABLES, ETC.
---	--

Call today for pricing!

- VERTICAL SYSTEMS
- EXCELLENT DOCUMENTATION
- TURN-KEY SOLUTIONS
- PROVEN SOFTWARE PACKAGES
- STAND ALONE OR INTEGRATED MODULES
- CUSTOM DESIGNED SOFTWARE

COMPLETE INDUSTRY SPECIFIC SYSTEMS

<ul style="list-style-type: none"> • AUTOMOTIVE DEALERS • AUCTION MANAGEMENT • GLASS DISTRIBUTORS 	<ul style="list-style-type: none"> • TELEMARKETING • MANUFACTURERS REP. COMPANIES • OFFICE PRODUCT DISTRIBUTORS
--	--

And many more custom designed to fit your business!

Authorized DataGeneral System Supplier
COMMERCIAL DATA SYSTEMS
404/799-1000
1000 SOUTH PIONEER DRIVE SMYRNA (ATLANTA) GEORGIA 30082

Circle 8 on reader service card.

exotic algorithms in an attempt to produce results that are accurate to four decimal places, and that are universally applicable. I'd invest in a perpetual motion machine before I'd bank on these guys producing numbers of anything more than academic interest. I've attended a couple of PMG national conferences before and gained some interesting insights into the nature of performance analysis and modeling, but accurate numerical results? Not yet.

At least the most distinguished panelist, Dr. Domenico Ferrari of UC Berkeley, was quite candid in admitting that after 25 years in the business, the biggest problems are still accuracy and extensibility.

Compounding the problem is the fact that AT&T Unix contains precious little performance data collection compared to operating systems like AOS/VS. According to DG insiders, this will definitely change in the case of DG/UX. I look forward to seeing the results.

:REALITY:AUTOBAUD

Yes, hitting NEW LINE or CARRIAGE

RETURN a seemingly random number of times in order to get the logon banner is truly a pain. Who did the beta testing, and why did they sign off on this new functionality? And how is it that nobody complained that there is no timeout on AUTOBAUD lines until the logon banner is displayed?

We're still going through gymnastics around here trying to build a BLAST script that will log on reliably in a finite amount of time. I'm going to plagiarize Memorex's ads and get some bumper stickers made up that say "Is it dead, or is it /AUTOBAUD?".

:ERRATA?

Phil Horvitz called to say that I was wrong in accusing Wordperfect of doing binary screen I/O unnecessarily, and that the spelling checker uses shared page I/O, not direct block I/O.

This column was prepared using Wordperfect 4.2, and I used the AOS/VS debugger on it a few minutes ago to check the ?WRITE packet used when doing a

down-cursor command. The packet specified binary dynamic I/O, not binary data-sensitive.

I also just ran the spelling checker on this column using the standalone version (SPELL.CLI/SPMAIN.PR). It took over five minutes of CPU (!) and used direct block I/O, not shared page I/O. However, checking the spelling while in the word processor does appear to use shared page I/O and seems to consume somewhat less CPU. Δ

Brian Johnson (BJ) is the President of B.J. Inc., a San Francisco based consultancy specializing in system auditing, system management, and performance analysis. :SYSMGR is a division of B.J. Inc. BJ can be reached at 109 Minna St., Suite 215, San Francisco, CA 94105, 415/550-1444. The :SYSMGR bulletin board number is 415/391-6531 (1200/2400 with optional MNP level 4, CHAR/605X/AUTOBAUD) or 415/550-1454 (voice).

FINANCIAL MANAGEMENT SOFTWARE FROM MAXON COMPUTER SYSTEMS

GENERAL LEDGER
ACCOUNTS PAYABLE
ACCOUNTS RECEIVABLE
TAILOR-MADE DISTRIBUTION SOFTWARE

Responsible purchasers of Financial Management software demand proof of performance – up front.

They call MAXON for a demonstration.

Ask MAXON to show how Maxon software is designed, optimized, and continues to be enhanced for the Data General environment.

Ask MAXON about Maxon's high functionality and unparalleled performance.

Ask about installation.

Ask about training.

Ask about support.

Seeing is believing.

MAXON
COMPUTER SYSTEMS INCORPORATED

AUTHORIZED  Data General SYSTEM DISTRIBUTOR

Call:
(212) 227-1922

MAXON COMPUTER SYSTEMS INCORPORATED
575 Madison Avenue, Suite 1006 New York, New York 10022
85 Scarsdale Road Toronto, Ontario, Canada M3B 2R2

Circle 40 on reader service card.



Informed buyers make better buys. Experience MAXON Financial Management Software.

Winner of Customer Satisfaction Awards for previous three years.

Over 200 companies currently operating Maxon Financial Management Software.

MAXON is an Authorized Data General Systems Distributor.

Data General is a major force in the computer industry and has installed over 226,000 computer systems worldwide since its founding in 1968.



A · n · n · u · a · l · . . . C · o · n · f · e · r · e · n · c · e

16th

*The 16th Annual NADGUG Conference will be held
September 18-21, 1989 at the New Orleans Hilton.*

*Conference '89 takes us to New Orleans -
the location of NADGUG's first annual conference.
We're back and stronger than ever. And this year,
another first for NADGUG - you'll find us
in the New Orleans Convention Center.*

Watch your mailbox - details coming soon!

**NORTH AMERICAN
DATA GENERAL
USERS GROUP**

**800/877-4787
(1-800-USR-GRUP)**

Short accounts

Small discoveries on a variety of topics

This month I want to highlight numerous little discoveries, most of which involve trivial items that I've happened onto in the last few months.

Secrets

Let's start with one of my favorite topics: best-kept secrets. There are two products in the 5000 series of DG's product list that appear to have a lot of merit but have had very little exposure. I think I'll present the problem first and then the solution.

A client has some large data bases requiring daily backups. Since he's running BBASIC (or B32 or ICOBOL) he can't use INFOS incremental file dumps. He thought of buying a 6250 tape drive but the price tag of nearly \$30,000 was a sobering thought indeed. He looked at third party solutions and found a similar tape unit for \$17,500. However, he doesn't want to lose DG maintenance. For the same reason, he also ruled out the Megatape cartridge units.

The solution? How about a DG 5080 and a refurbished 6026 (total price about \$20,000)? The Model 5080 is a 600 MB cartridge tape unit that uses a serpentine recording method and can back up a full 354 MB Argus in 10-12 minutes. This should sound a lot like the Megatape 600 MB unit. If you put the two units side by side, you will see variations in the color of paint and brand name logo. Open them up and only an engineer could spot any

differences. The used 6026 provided the client the compatibility to talk to the rest of the world with standard magnetic tape, and it serves as an alternate backup medium if the 5080 is down.

Here's another little-known beauty. Suppose you have a client who decides to upgrade to a used MV/4000. He is planning on having a couple of modems on his system but also has about 10 in-house users. An IAC-8 won't provide enough ports, two IAC-8s give him more modem control than he could ever want but take two slots, and an IAC-16 has the ports but no modem signals.

Enter the Model 5916. It's an IAC-16 with a twist. Twelve lines are like the IAC-16 and require only pins 2, 3, and 7 in your cable and four lines have full modem control like the IAC-8. It gives you the best of both boards with the maintenance cost of one board.

Horrors

A site I know of recently learned a bitter lesson about backups. To save money, this accounting firm decided not to purchase a maintenance contract. They had minor problems with their 6026 tape unit, but since it was the busy season for accounting firms they ignored the unit and did not make any backups. A little over a month later they lost their disk unit (I believe it was a head crash). Their situation could be summarized as this: they were at the peak of their busy season with dozens of tax forms due in the immediate future, they had a system with no tape and no disk, and they lost almost six weeks' worth of data entry due to lack

of backups. It turned out to be cheaper and faster to buy a new disk and new tape unit instead of fixing the old ones.

The client's savings from cutting out maintenance coverage for about six months was \$5,000 or so. He lost disk and tape units worth about \$10,000—and he lost the month and a half of work by 14 full-time terminal operators. Even at minimum wage that amounts to nearly \$20,000 with taxes and benefits. Thus, his supposed savings of \$5,000 turned into a net loss of \$25,000. The morals of this story are: if you go to time and materials, you're gambling; if you don't make backups, you're asking for trouble; if you have a hardware problem, don't ignore it.

Bugs

An ICOBOL bug? Naw, it couldn't be. Not good old reliable ICOBOL; but I recently had a number of programs that were aborting the cross-reference listing in the literal pool after printing the following: "UNKNOWN MESSAGE CODE 00012317, ILLEGAL CHARACTER IN ARGUMENT." I suppose if I had been keeping up to date on my ERMES file the message might have read a little differently, but that wouldn't have stopped the error from occurring. What I really wanted to do was get rid of the error. Well, I can't.

It can be reproduced with the following: MOVE LOW-VALUES TO X-FIELD. MOVE HIGH-VALUES TO X-FIELD. STOP RUN. One byte of nulls and one byte of high-values end up back-to-back in the literal table. When the literal pool listing was generated it was treated as a single 2-byte literal. Then when XLPT sees

it the null is ignored (I think) and the high-values (377 octal, FF hexadecimal) make it think that a VFU sequence is going to follow. It then blows up when it gets a bunch of spaces. Thus there are two things that need to be done.

First, make sure that low-values and high-values are properly stored as two separate fields in the literal pool. Second, add some smarts to ICObOL to display octal or hex values of nonprintable literals in the literal pool as opposed to printing the literal exactly the way it's stored internally.

XLPT

Something good in XLPT 7.62? Sure. And it may have been there for some time. I don't know when it was added but we discovered something intelligent in XLPT yesterday. I will, on occasion, print a small report for which I am only interested in the totals. The other day I ran a report on a live data base that produced a huge file. I didn't know how many pages were to be printed and it turned out that I overstated the QPRINT/FIRST= command. I guess I haven't done that in years because XLPT printed a page telling me that I overshot the end of the report. The exact message was "BEGINNING PAGE GREATER THAN ENDING PAGE", "BEGINNING PAGE IS 100, ACTUAL ENDING PAGE IS 84". The first line seems to be an impossible statement until you add the implied word "DESIRED" in front of it.

By the way, I have another good thing to say about XLPT and report spooling in general. Thanks for the QMODIFY command. I knew it was probably coming in 1983 when DG answered my STR with "TO BE CONSIDERED IN A FUTURE REV." Then we were told it was coming two years ago. Anyway, now that it is here, it sure is convenient.

Speaking of spooling, it really should be SPOOLing. Trivia time. What does "SPOOL" stand for? Correct answers win a free drink at the DG reception in New Orleans.

Support

The new policy to bundle SPSA with software support for the first machine on every site has obviously done more harm than good for smaller users, especially since they found out about another policy that has been around. This policy al-

lows any legally licensed site to purchase a one-shot upgrade for the going rate (approximately \$1,200 for AOS/VS). I spoke to Frank Keaney from Data General about this and pointed out there are a lot of people who don't want SPSA. For many it's not a question of money or service, it's just that they feel perfectly comfortable letting their own in-house staff support the system and troubleshoot all

software problems. All they want are new releases as they come out. You can get them by ordering the -20 suffix for your software. If you have an AOS/VS model 3900, you order 3900-20m where "m" is the media type to obtain the current version of software.

The one-shot purchase policy will allow you to get software without support, but it has three major drawbacks, all of

ANNOUNCING REV 2.00!

We've done it again! Following hot on the heels of our other bestseller, *THE ULTIMATE*, we are pleased to announce the release of **The ULT Routines Library rev 2.00.**

Now containing over 200 assembler routines the **Ult Library** is a must for all **VS Cobol** installations. Combining the speed of **Assembler**, simplicity of use itself, and plain readability (e.g: CALL ULT.GET.USERNAME, CALL ULT.PULL.DOWN.MENU, CALL ULT.SEND.IPC.MESSAGE) the Library provides all the system calls that will ever be needed in a commercial environment . . . and then adds to this an unparalleled array of features which enable the system designer to specify the most complex systems hand in hand with smooth and highly sophisticated user interfaces, in the knowledge that the programmers will actually relish the chance to use some ULT routines . . .

For instance:

- PC like user interfaces, e.g. pull down menus & windowing, without having to worry about terminal types and building of escape sequences. Just call our routines.
- Multitasking COBOL to enable you to write powerful and sophisticated applications. Only one package allows you to multitask Cobol programs, the **Ult Library**.
- IPCs and Process Management made easy.
- Extensive array of string manipulation routines. Ever been frustrated by the amount of code needed to perform relatively simple string manipulations? *Look no further!*
- EXEC support – Networking support – CLI features such as: QPRINT, QBATCH, QDISLAY, FTA, DIR, [!USERNAME], F, WHO . . . the lot!
- Routines to fully integrate your applications with CEO, e.g. create CEO-like menus, read Inbox, etc . . .
- And lots more . . .

For more details urgently contact:

North America – DataLynx Inc.
6659 Convoy Court, San Diego, CA 92111 (USA)
Tel: (619) 560-8112

Australia & New Zealand – Mini Computer Systems Pty Ltd.
411 Hawthorn Road, South Caulfield, Victoria 3162 (Australia)
Tel: (03) 528 2711

Otherwise – Le Software Man Ltd.
PO Box 545, London N7 8DF (England) Tel: + 44-1-809-2762

Circle 23 on reader service card.

which Keaney is very much aware of. First, most system managers have an easier time getting funds on a subscription basis with a flat fee as opposed to paying every three to nine months as new releases come out. The major complicating issue is that most management has no objections to spending a monthly or quarterly maintenance fee but they don't like the hassles of a complete purchase requisition/purchase order/billing and payables cycle for each upgrade. It also makes it harder to budget for.

The second is that there is no mechanism to let non-subscription customers know about new releases.

The third is that a site may encounter a problem with a specific revision, such as the AOS/VS 7.62 printer problems, that preclude using it. They should not have to pay again to get 7.63 or 7.64 or whatever revision finally fixes it. After all, they paid good money in the first place to get the new features. Why pay twice for something because the original product didn't work? Keaney and I talked about a

reasonable solution for this: each major rev, 7.5x, 7.6x, 7.7x, etc. would be subject to the upgrade fee from previous revs; but if you purchased a specific rev, say 7.62, all other rev 7.6x updates (7.63, 7.64, etc.) would be included under the one-shot purchase.

Magic

Recently someone wrote in that you couldn't write a CLI macro with the same name as a CLI command with the exception of XYZZY (pronounced "magic" for you non-Adventure buffs). That is an interesting exception. I have been trying for years to figure out whether or not that command will do something if given the proper arguments or working directory. However, you can write CLI macros with the same name as CLI commands. You just can't use them unless you put the command in square brackets. Examples: "QPRINT" will execute the CLI QPRINT command but "[QPRINT]" will read the file named QPRINT in your working directory or on your searchlist and execute

the CLI commands it hopes to find there. If the first occurrence of disk file "QPRINT" is a sub-directory, then you will get an error stating that QPRINT is the wrong file type and can not be used.

All's quiet on the western front

And the eastern one too. No cards or letters have graced my desk. Come on, folks, you can't have grown that reticent about DG systems. Let's get some cards and letters coming in. I can't promise to answer all questions, but those I can't will be forwarded to the correct people. So, until next time, keep in touch and maybe I'll see you in New Orleans at the fall NADGUG convention. Δ

Jim Siegman is a contributing editor to Focus, chair of the NADGUG Audit Committee, and treasurer of the Chicago Area Data General Users Group. Send comments or questions to him c/o Datamark Corp., 3700 W. Devon, Suite E, Lincolnwood, IL 60659; 312/673-1700.

SAVE — THAT'S THE RAVE WAVE!

DATA GENERAL SYSTEMS, PERIPHERALS, PARTS AND COMPATIBLE EQUIPMENT

Rave is second to none when it comes to quality equipment.

While we offer immediate delivery, nothing leaves our door until it meets

- Quality Equipment
- Immediate Delivery
- Competitive Pricing

our high standards. Call and find out why Rave is the fastest growing Data General second source.

- Large Inventory
- Nova to MV
- 45 Day Warranty

Reliability - Availability - Value - Experience

**BUY • SELL
TRADE • LEASE**



RAVE COMPUTER ASSOCIATION, INC.

35455 Stanley Drive
Sterling Heights, MI 48077
FAX: 313/939-7431

DATARAM
AUTHORIZED DEALER

ZETACO
AUTHORIZED DEALER

313/939-8230

Circle 46 on reader service card.

Tools you can depend on

In some professions your life depends on the tools you choose—so you choose the best.

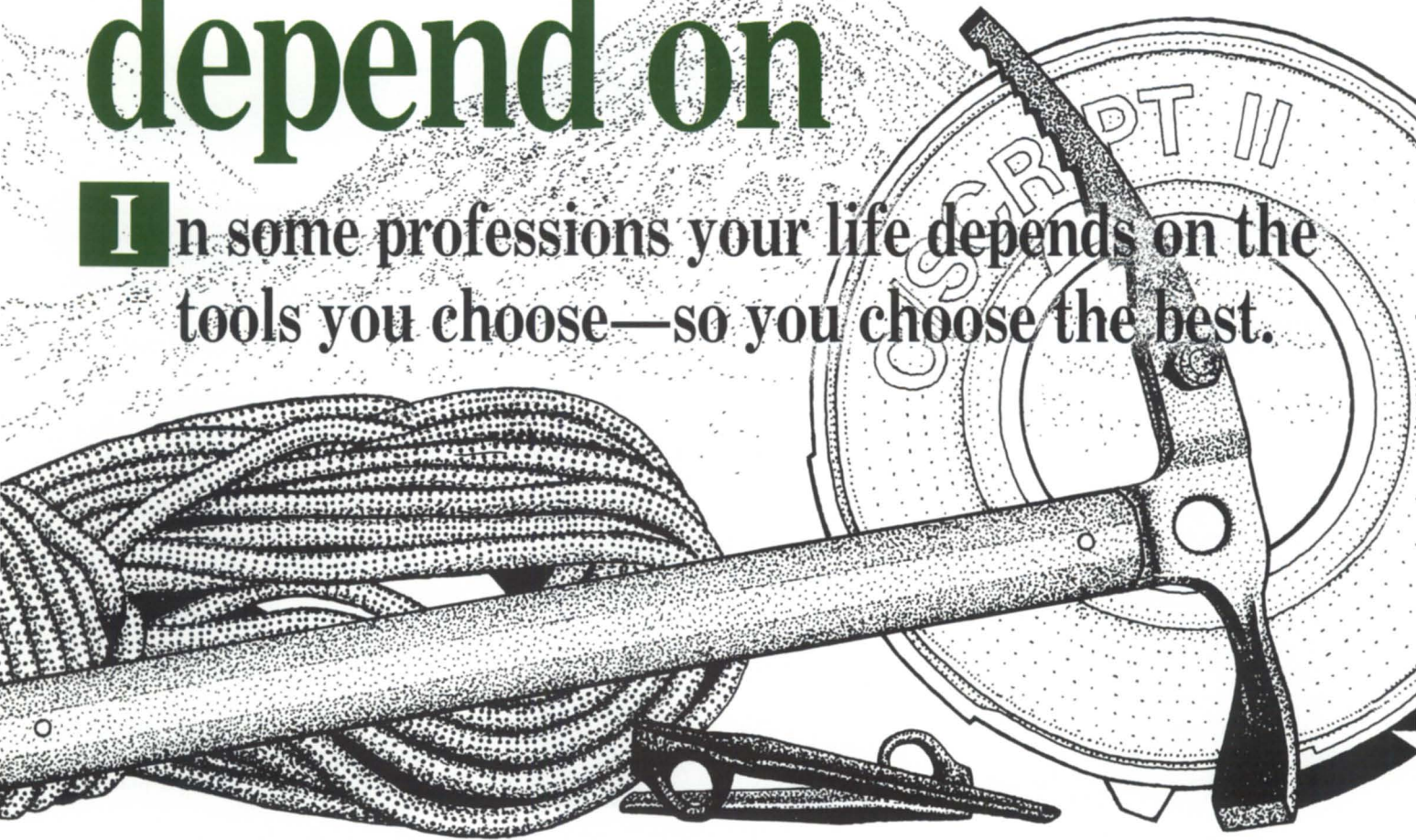

- **C/SCRIPT** - COBOL application development system.
- **Screen Demon** - Pop-up windows for DG terminals. Hot-key calculator, CLI, print screen, and more. Works with existing COBOL programs.
- **ICHOST** - Single and multi-terminal ICOBOL interpreters for MS-DOS systems. Up to 33 users. Fastest product of its kind.
- **Scream** - Fast file Transfers over ASYNC lines.
- **DG Dump/DG Load** - Create and load DG-compatible dump files on your MS-DOS or Unix system.
- **ICOBOL to RM/COBOL Translator** - Translates ICOBOL source code to RM/COBOL.
- **ICIO** - Access ICOBOL data files from a 32-bit program.

For more information

(205) 821-0075

Threshold, Inc.

165 East Magnolia • P.O. Box 831 • Auburn, AL 36831

Circle 60 on reader service card.

C/SCRIPT is a registered trademark of Threshold, Inc.

STREAMLINED

Improved menus eliminate guesswork for DG's On-line Information Service

by George Tuthill and Linda Strenck
Special to Focus

OIS, Data General's On-line Information Service, was created to simplify information flow concerning products, services, and support between Data General and our customers. Since its introduction in 1986, OIS has matured and expanded into a valuable on-line data base.

Available seven days a week, 24 hours a day, OIS offers the latest information on Data General products and services. It also provides a user-to-Data General communications channel for submitting questions and Software Trouble Reports (STRs), and user-to-user communications through the bulletin boards. Over the last year, the OIS menu structure has been simplified so that both expert and novice users can find information much faster. If it has been a while since you have logged on to OIS, take a few minutes to read this article. The service has become streamlined to save you time and money when you are logged on.

A banner page welcomes you to the service and notifies you of any new messages. Next you will see the OIS main menu as shown in Figure 1.

Structured into three main segments, the main menu spells out clearly where you should go to find the information you want. Interested in a Software Trouble Report? You know right away that there are two areas pertaining to STRs, menu choice number 1 and menu choice number 6. Looking to access a bulletin board? You clearly know that menu item num-

ber 7 is an appropriate choice. This improved menu eliminates the guesswork. You will not waste time accessing choices that are not what you are looking for.

The first segment of the main menu contains Data General technical and independent vendor information.

Figure 1: The OIS main menu

```

On-Line Information Service
1. STRs, Patches, Bulletins
2. Software Shipment Schedule
3. ISV Forums
4. New Articles
   ***
5. Electronic Mail
6. STR Submission and Status
7. NADGUG Bulletin Boards
   ***
8. DG Services
9. Usage Tracking
10. User Assistance
Enter choice!
  
```

Choice number 1 (STRs, patches, and bulletins), and **choice number 2** (software shipment schedule), contain technical information provided and maintained by Data General. Upon accessing one of these menu choices, you will see that it is further divided by product name, such as AOS/VS, RDOS, CEO, for example, so you can choose the product you are interested in.

Choice number 3 (independent vendor information) gives you access to information provided by major independent software and hardware vendors primarily for the MS-DOS/PC world. Vendors such as Ashton-Tate, Microsoft, Apple, DEC PC, IBM, and Hewlett-Packard are included.

Choice number 4 (new articles) provides the latest software bulletins and Data General announcements.

The second segment of the main menu is user communications. There are two

distinct capabilities provided, user-to-Data General and user-to-user communications. This segment offers you, as an OIS user, the ability to communicate directly with Data General and with your fellow users.

Choice number 5 (electronic mail) provides you with your specific mailbox, where your messages reside. Pre-determined forms for mailing requests to Data General are also found and categorized into product related questions, service related questions, Software Assistance Requests (SARs), OIS feedback, and on-line STR submission. When you send a message to Data General, you'll receive a certification in your OIS mailbox and you will generally receive a response to your message within two working days of receipt of the message.

Choice number 6 (STR submission and status), enables you to submit a new STR, or check the status of an STR that has been previously submitted.

Choice number 7 (NADGUG bulletin boards) facilitates access to bulletin boards sponsored by Data General and maintained by North American Data General Users Group (NADGUG), for its members and non-members. The major capabilities of the bulletin board are user-to-user communications with messaging and conferencing capabilities, a public domain software data library with the ability to upload and download files (with the proper software), user options that allow the flexibility of customizing the bulletin board to suit your needs, and extensive on-line help to aid you in using the bulletin board. Remember, bulletin boards, both NADGUG and ISV forums, are provided for the benefit of all Data General users. They enable you to ask questions and provide input to others users' questions without leaving your office or home.

The third segment of the OIS main menu is on general information and Data

General services.

Choice number 8 (DG services) contains information on support services, consulting services, educational services and technical information, and publication services. If you are looking to purchase a service contract for your Data General hardware and/or software, or need a training course or a technical manual, you will find all your options in this section. Toll-free numbers are also available to call for additional information or sign-up.

Choice number 9 (usage tracking) enables you to determine the time used on the service for the current month and the time and charges incurred for prior months. You have the ability to always know how much time you are spending on OIS in any given month.

Choice number 10 (user assistance) contains general information on how to change your password, general systems help, synonyms, navigation commands, direct access to the phone book, legal notices, and the on-line OIS users guide.

When you log on to OIS, you may choose the area you want by menu choice number. Or, you may navigate through the database via menu, article, screen, and control commands or the "Go" command. You'll find that the new menus clearly indicate what is contained within, and with considerably fewer menus to navigate through, the effort required to access your information is reduced.

More protocols have been added to allow patches to be downline loaded. OIS now supports Blast, OIS Connection, X-Modem, and B-Protocol; in addition, the newest revision of AOS/VIS (rev 7.62 and above) includes an OIS interface that allows faster and easier connection.

The improved service was demonstrated at the last NADGUG conference, and users who stopped by and tried OIS were very pleased with the user-friendliness of the OIS data base restructure. Many of the changes made to OIS were implemented in response to comments, ideas, and suggestions submitted by OIS

George Tuthill is a program manager for on-line services at Data General. Linda Strenck is a Data General marketing communications specialist. For more information on OIS, call 1-800/325-3065 or 1-800/952-4300 (in Massachusetts).

users. And, more improvements are planned. Data General is developing an electronic ordering system to allow OIS users to electronically order Data General accessories and supplies. More detailed information will be available in the near future.

The hourly rate for accessing the chargeable areas of OIS is \$45. NADGUG members and subscribers to Data General's

Support Plus or Software Support Line packages receive one free hour of use per month.

We urge you to give the improved OIS a try, whether you are an existing user or a potential user. Then, let us know what you think. Working together, we will enhance existing options and add new options to provide you with the most comprehensive on-line data base available. Δ

DG/hot site From Data Assurance Corporation

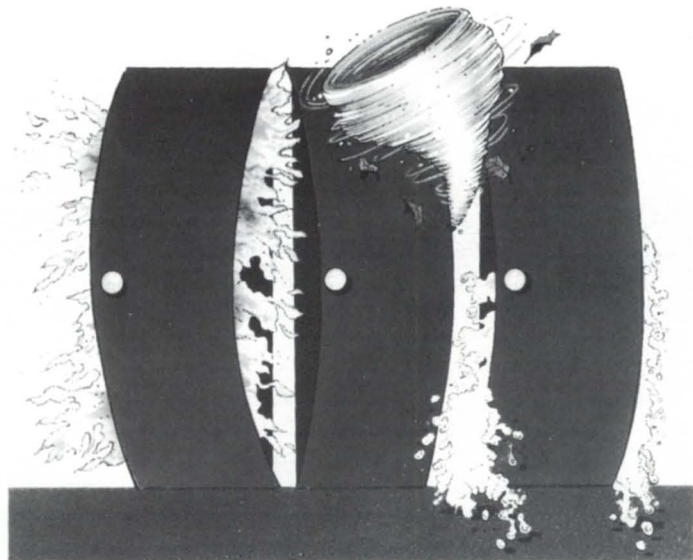

Data General has qualified Data Assurance as a provider of **DG/hot site** services, based on DAC having met criteria established by DG. Why? Because DAC is the only nationally recognized company dedicated solely to disaster recovery services.

- **More subscribers** than all of our competitors combined — which means we can offer the lowest fees in the industry.
- **More DG equipment dedicated exclusively to disaster recovery** than any other company . . . DAC's MV/20000 Mod 2's and MV/10000's can support up to 1400 on-line users.
- **Dedicated, high speed packet switch network links** allow public data network access from anywhere in North America.
- **More experience** in recovery operations — including hundreds of successful on-line and live tests — and the only responses to actual customer emergencies.

For more information on **DG/hot site**, call us toll-free **1-800-654-1689**

6551 S. Revere Pkwy, Suite 130
Englewood, CO 80111
(303) 792-5544



**Data Assurance
Corporation**

2 New Road, Suite 103
Aston, PA 19014
(215) 358-0104

DAC is an independent company providing its disaster recovery services for users of **DataGeneral** equipment.

Circle 17 on reader service card.

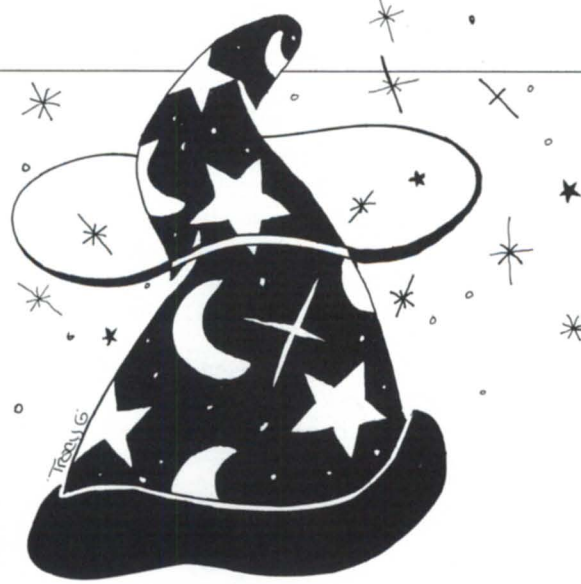

Under Wordperfect's Spell

Spell-check ensures accuracy of documents—and makes crossword puzzles a breeze

by Guy Pribyl
Special to Focus

Wordperfect's Speller does far more than merely correct your spelling. As Wordperfect users who use the speller soon discover, it contains many powerful features. In fact, using the speller is like having a highly efficient secretary at your beck and call.

Wordperfect's Speller contains 115,000 words, including 10,000 legal and 15,000 medical terms.

To start the speller, press Spell (Ctrl-F2). The following menu appears: **Check:** 1 Word; 2 Page; 3 Document; 4 Change Dictionary; 5 Look up; 6 Count

Let's examine the speller menu options one by one. Options 1-3 let you have the speller check a word, page, or complete file. You can also check only a block of text, by highlighting the block you want checked and then pressing Spell.

Change Dictionary

The Change Dictionary (Option 4) lets you use specialized dictionaries you create, or other dictionaries available from Wordperfect. Wordperfect Corp. has developed several foreign language versions

complete with foreign spellers. These spellers can be purchased separately for use with Wordperfect in English. Current languages available include Catalanian, Danish, Dutch, UK English, French, Canadian French, German National, German Switzerland, Icelandic, Italian, Norwegian, Portuguese, Spanish, and Swedish.

Look Up

The Look Up (Option 5) is my favorite feature. It is available both from this menu and while you spell-check a document. It lets you type in a word pattern and have the speller search through the 115,000 words it contains, bringing up every word that matches the pattern. For instance, if you enter "add-t-ly," the speller displays every word that starts with "add," has a "t," and ends with "ly".

Look Up is handy to have around when you're doing crossword puzzles. If you type ??T??Y the speller will search through the dictionary for all words that are six characters long, with a "t" as the third character and a "y" as the last character.

Once I was demonstrating this feature to a surgeon. Since I happen to know that surgeons take an avid interest in words that end with "ectomy," I typed in "ectomy" and brought up a long list of the words. I was amazed at the surgeon's reaction. He became quite excited and exclaimed, "Wooooowie! Look at this!" Then he pointed at one of the words and observed, "Imagine that! I haven't performed one of those in a long time." Since

most of the words displayed on-screen contained the various parts that can be cut out of a human body, the surgeon's enthusiasm almost alarmed me. I hoped that he wasn't looking me over too closely as he examined the words.

Having an option like the Look Up feature can be very useful. For example, the other day I simply couldn't remember a word that was almost right on the tip of my tongue. I only knew that the word started with an "e" and ended with "ious". Fortunately, Wordperfect's Speller was there to jog my memory. I typed in "e-ious" and instantly recognized efficacious when it appeared on the screen.

Count

The Count (Option 6) quickly counts the number of words that are in a file. Anyone who has ever been required to do a 5,000 word essay knows how useful this feature can be.

Using the speller

As we mentioned above, when you select Word (1), Page (2), or Document (3), the speller begins checking words. The speller searches for transposition errors, characters that have been left out of a word, and characters that have been incorrectly added to words. The speller also checks for numbers accidentally added to a word. If it finds a word in your document that it can't find in its dictionary, the speller assumes that the word is misspelled and highlights it on-screen. It then begins displaying a list of words that look or sound like the misspelled word.

The speller also checks a word phonetically, and displays any words that sound like the word. I've really enjoyed this feature. If I'm not sure of the spelling of a word, I just type it in the best I can. The speller does the rest. Ninety percent of the time, the speller finds the correct word for me.

Whenever a misspelled word is highlighted, the following menu is displayed at the bottom of the screen: Not Found! Select Word or Menu Option (Continue=0); 1 Skip Once; 2 Skip; 3 Add Word; 4 Edit; 5 Look Up; 6 Phonetic

If you want to leave the word just as it is, select Skip Once (1) or Skip (2). Skip Once skips the word that one time and displays the word whenever it is found again. Skip (2) temporarily adds the word

to the speller's dictionary and ignores that spelling for the rest of the spell check.

If you want to add the word to your speller's dictionary, select Add Word (3). The word is then added to your speller's supplementary word list. This feature lets you develop a personalized dictionary as you work. You can edit your supplementary word list by retrieving the LEX.SUP file into Wordperfect. Supplementary dictionaries can also be added to the main speller by executing the speller utility (see speller utility below).

Select Edit (4) when you just want to fix up a word slightly. You can then edit the word and press NEW LINE to continue using the speller. Note that you can use the Look (Option 5) from this menu.

Selecting Phonetic (6) has the speller list all the words that may sound like the word. For example, if I select this option for my name (Pribyl) the speller pulls up "prebill" and "preboil". (My sincere attempts to get my name added to the speller have as yet, unfortunately, been unsuccessful.)

Often I select Phonetic to find words that rhyme with a particular word, or sound like it.

As the speller displays possible word alternatives, each one has a letter beside it. Selecting a letter causes Wordperfect to replace the misspelled word with the new word, retaining the same capitalization and bold and underlining features. The speller then quickly moves to the next misspelled word.

The speller has another useful feature. Often I find myself typing the same word twice (for example, "gone gone" or "one one"). This is sometimes referred to as "stutter typing." To avert it, the speller stops at each occurrence of a double word to make sure that it is intentional.

Speller utility

The speller also comes with a convenient utility, Wordperfect Speller, that you can run outside of Wordperfect by entering SPELL at the CLI prompt. You can use it to display the common word list, check the location of a word in the word list (whether it's in the main dictionary or

Guy Pribyl is director of marketing, Data General products, at Wordperfect Corp. He may be reached at 1555 North Technology Way, Orem, Utah 84058; 801/222-4100.

a supplementary one), change dictionaries, create a dictionary, add words to a dictionary, delete words, and organize the words in your dictionary so they are easier to find. It also lets you do background spell checks without having to go into Wordperfect, giving you a list of all the particular words that are misspelled in a certain file.

Write for you

In short, if you don't like having to hunt through dictionaries but you do want correctly spelled text, take the time to learn how to use the speller. In the words of an old song (with lots of pun intended), it will soon have you under its spell. (You can even put your name in its dictionary.) △

How many sales have you lost by depending on a single hardware vendor?

ICOBOL
on
UNIX

Wild Hare's *Choice!*[™] software gives you the market and vendor freedom to immediately sell your ICOBOL applications on all types of computers - from small PCs to large mainframes!

Take a close look at how our soft-solutions can help you reduce high hardware and development costs, enhance and protect your software investment, give you true vendor independence and open new markets to your products.

Wild Hare means vendor independence.

Call today for more information
(303) 442-0324



wildhare
COMPUTER SYSTEMS INC.
P.O. Box 3581
Boulder, CO 80307

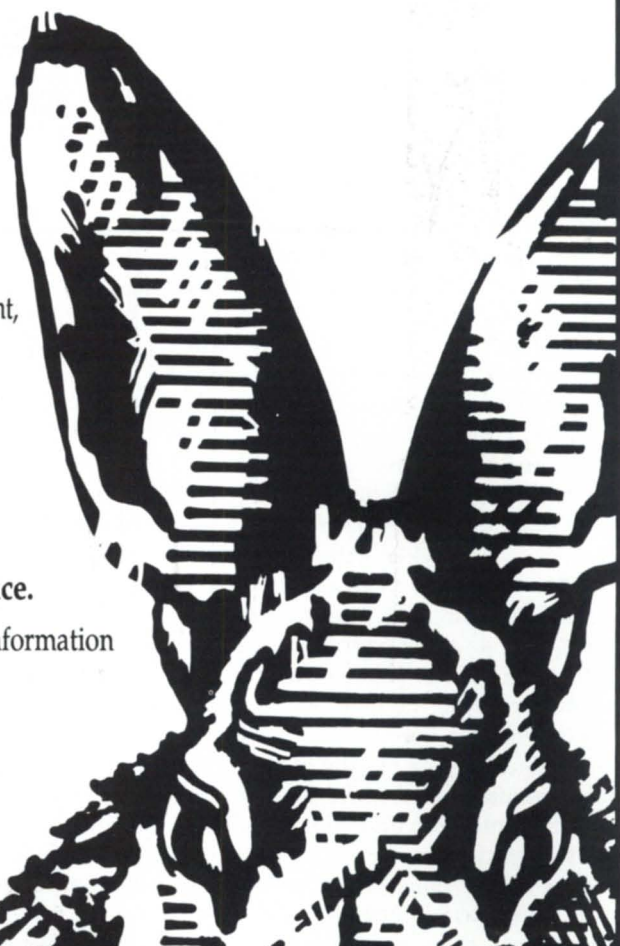

Circle 66 on reader service card.

Adventures await

The three 'I's of writing computer games

by Larry Morse • Special to Focus

Computer games have been a part of the lore of computers since the days of the UNIVAC, punch cards, and hardcopy terminals. Building upon these early beginnings, the industry has made mind boggling advances in hardware, software, and system capabilities, yet we still have a tendency to informally show off the power of a system by the quality of the games it can play.

Early system programmers produced "can't lose" tic-tac-toe; today we have machines that can compete in world-class chess tournaments. As more advanced systems became available, we progressed from Pong to Pacman to Nintendo, and at each step games became concrete examples of the application of new technologies; they also showed us that computers can be fun.

In this article I will present some general ideas about the key elements of a good game. We'll look at various types of games and how to choose those most suited for implementation on Data General systems. You'll find out where to get ideas for games, and finally, I'll give you some strategies you might use for designing and writing your own games in the DG environment.

In the broadest sense computer games can easily be grouped according to purpose, since they generally serve one of two basic ends. Most games either attempt to teach us something or provide us with entertainment. Therefore we describe them as either educational or recreational. Educational games tend to focus on providing the user with a novel way to learn a specific skill or build knowledge; they are usually designed to fulfill specific educational objectives, and often concentrate on providing repetition and practice.

Recreational games have no agenda other than entertainment. In order to attract players, recreational games usually

focus on action and activity, and rely on the appeal of color, graphics, and motion or animation.

Most Data General systems are not set up for color and fast graphics, and run-

games that will run efficiently in a Data General environment. All we have to do is choose game models that make optimal use of the system's strengths and minimize demands on system resources such as asynchronous I/O paths.

There are three major factors that influence the quality (and playability) of a computer game. Good games are always highly interactive. They are interesting, and they possess some degree of intelligence. Let's look at how to optimize these "three I's" for a Data General environment.

Interactivity—One basic goal in game design is to always keep the player busy. If we can't keep him physically busy (as Nintendo does) we can still keep the player focused by making him "feel" busy performing mental activities associated with the game. Chess games require minimal terminal I/O, yet the player is still highly involved in the game. Games that involve thinking rather than doing can be very interactive; the nature of the interactivity may be different, but the game intensity is still maintained.

Interest—If a game doesn't keep the player interested, the player will quit (and probably never return). Here are some suggestions for revving up the interest level of a game:

- The single most important factor influencing a player's interest in a game is the challenge level. Since we know that physical challenges are not advisable in a DG environment the challenge should be addressed toward mental activities. There are two dimensions that influence the picking of a challenge; both the intensity and duration must be appropriate for the player. If a challenge is either too hard (intensity) or takes too long (duration) a player will find it difficult to achieve closure and interest will slip away. On the other hand, if the challenge is trivial the player will get bored. A carefully thought



ning the terminal I/O intensive code needed to simulate motion can create problems on a multiuser environment. When I play a "green screen" version of Pacman on our marginally loaded MV/8000 system it quickly garners a rash of phone calls from people with loud voices and little patience. How, then, can we implement high-power recreational games on a Data General system? The answer is in most situations we cannot (or at least shouldn't); however, this doesn't mean that we can't produce good

out and well-managed challenge will ensure player interest.

- Theme-based games by their nature generate interest. The only problem you face is that the theme must be appropriate and carefully selected for a target audience. Young children might love a game based on *Winnie the Pooh*, but an adult audience would probably lose interest fast.

- Good games are usually designed around a subtle pattern, but rote repetition is an invitation to boredom. I was once asked to comment on a game a friend created to teach his third grade son the state capitals. It went like this:

Name the capital of Alabama _____
Good work!

Name the capital of Alaska _____
Good work!

Name the capital of Arkansas _____
No, try again!

I quit with Colorado, and my comments should be obvious.

Intelligence—Here is where good programs, optimized to take advantage of

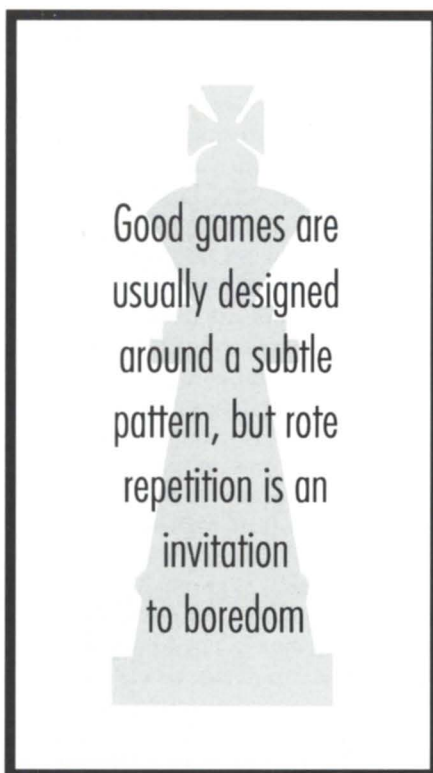

the DG environment, can shine. If you can't wow players with glitz, show them some smarts. If a game is language-based, implementing a good natural language parsing algorithm is worth the effort. I've seen some implementations of *Adventure* and *Zork* that are amazing.

So far we've talked about designing either an educational or recreational game, optimized for a DG system, that is interactive, interesting, and intelligent. Now comes the hard part. How do you come up with the basic idea for a game? Let me offer a few suggestions:

- An easy way to get started is to simply rebuild an existing game to host on your system. If you don't get too vain about originality you should be able to make a lot of good games run in DG land without too much effort.

- Create an educational game as a direct solution to a training problem. Usually these problems are easy to find, and a game might present a novel solution.

- Model a classic game. The ideas are already there; all you need to do is move

Disk/Tapes • Entire MV/ Line

• MV/1400-MV/40000

2 Gigabyte Tower

2 Gigabyte Drive

and the tape to back it up!

Delphi Data

(714) 354-2020 Fax: (714) 279-7957

9069 Cajalco Road, Building 1 • Corona, CA 91719

**Call for your
VAR pricing.**

Circle 26 on reader service card.

them onto a system.

• The puzzle pages of science and math magazines are a good source of basic ideas. Try browsing through some old issues of *Scientific American* and you will see that with a little creative thinking puzzles can easily be made into games.

Once you have an idea in mind and it's translated into the basic concept for a game, the nuts and bolts of building the program need to be worked out and implemented. It is at this level that attention to detail becomes paramount; a good concept filtered through inappropriate or poorly written code usually results in a not-so-good game. Here are some general strategies that may help:

Human engineering—Good human engineering is simply the result of applying basic common sense, but there are some details that do need careful attention. The user interface must be crisp and uncluttered; long and wordy instructions or responses should be avoided and nothing should appear on the screen unless it directly relates to the player playing the

game. The player should always know what to do next (move or play options, restart?, exit?, pause?) and it should be easy for him to perform the necessary functions (I prefer single key entries using simple keys such as ESC, HOME, arrow keys, and NEW LINE. For complicated games or when there might be confusion, a help facility might be warranted.

Playing mode—In games involving competition there are three basic ways a player can compete: against himself, another player, or the computer. Make sure the player understands who the competitor is, and the way that the competition is measured. If scores are maintained, there should be a mechanism that allows players to save at least high scores for later sessions or bragging rights.

Graphics—Jazzy graphics and color are not implementable in most DG environments, but that is not to say that you should give up completely. With a little practice and some ingenuity you can create some pretty nice looking displays; remember that this is what DG users are

used to and all they expect! Combinations of "stars and bars," reverse video, underline, and blink can produce some good results. For example, I have a set of suit identifiers I use in card games that looks like this:

```
( )  /\  ( \ / )  /\
( ) ( < > \ / / \
/\  \ /  \ /  ( / \ )
```

Try punching them up on a Dasher and you'll see that they look pretty good.

In summary, there is hope for games in the Data General environment. You can find, design, and code games that you and your colleagues will enjoy playing. You will have the satisfaction of knowing that you created a diversion that makes our systems a little more fun. △

Larry Morse is a senior systems training specialist with Data General Educational Services, and has developed several games that run on Data General systems.

Why blast your CPU...

TurboTran
(XMODEM/YMODEM)

Error-Free
file transfer
that won't drive your
system into the dust!

TurboTran Includes:

- Checksum & CRC Modes
- Integration with CEO
- PC Support Utilities
- AOS & AOS/VS Systems
- Many Other Extras!

\$225

30 Day Risk Free Offer

Data Bank Associates, Inc.

20010 Century Blvd., Suite 104
Germantown, Maryland 20874

(301) 540-5562

FAX# 301/540-8105

Circle 18 on reader service card.

DG & COMPATIBLE
BUY • SELL • LEASE

CPU

MV/15000, 20000
MV/10000
MV/8000
MV/7800
MV/4000, 4000DC
MV/2000
NOVA 4-C, S/20
S/140, S/280

MEMORY

for all MV &
ECLIPSE
for all NOVA &
MICRO

PRINTERS

4320 55CPS LQ
4589 SERIAL
4422 SERIAL
OKIDATA 192, 292
HP LASER JET II

DESKTOP

DG/10, 20, 30 PKG
DISK UPGRADES
USAM-4, USAM-1
CARTRIDGE TAPE
MEMORY

COMMUNICATIONS

IAC-8, IAC-16
TCB'S
COM BASIC I/O
ATI-16, AMI-8
ALM-8, ALM-16
MCP-1 W/TCB

DISK/TAPE

354, 592MB
96, 192MB
73, 147MB
10, 12.5, 20, 25MB
6231 CART N/E
6026, 6123, 6125
6299, 6300, 6021

CRT'S

6053, D-100, D-200
D-210, 211, 410, 460
D-214, 215, 411, 461
D-216, 412, 462, 470

COMPATIBLES

ZETACO CDC
FUJITSU SCIP
DATARAM STC

SPECIAL DG/10, 128KB, DUAL FLOPPY,
*** MONO MONITOR...\$495

AMES SCIENCES, INC.

2 EAST MAPLE AVE. TRAPPE MD21673
(301) 476-3200 • FAX 301-476-3396

Circle 2 on the reader service card.

**You wouldn't drive
a car without a
dashboard...
so why run
AOS/VS without
:PERFMGR?**

Includes a logging facility with report generator, real-time monitoring screen, file and directory structure analysis utilities and a tutorial on AOS/VS system performance analysis.

Join the hundreds of other System Managers who no longer run out of gas unexpectedly.

AOS/VS :PERFMGR \$499
10 DAY TRIAL COPY **FREE!**

:SYSMGR

Software for System Managers
A Division of B.J. Inc.

109 Minna Street, Suite 215
San Francisco, CA 94105 (415) 550-1454
Dial-up BBS (1200 baud): (415) 391-6531

Circle 57 on reader service card.

The latest products for DG systems

Two new terminal server products expand options

Westboro—Two new terminal server products from Data General expand DG terminal connectivity options in local and wide area networks.

Termcontroller is a single-board ethernet communications controller that connects an Eclipse MV family computer to an ethernet local area network (LAN).

For customers desiring direct asynchronous connection to MV processors, the company also introduced new Intelligent Asynchronous Controllers (IACs). The IACs come in 8-line and 24-line versions supporting RS-232 and RS-422 electrical interfaces. IACs are designed to increase CPU performance by off-loading asynchronous I/O processing from the host.

DG offers Termcontroller in two versions. The ITC-128 Termcontroller supports 128 sessions; up to 64 sessions are available for active users. The LTC-64 supports 64 sessions; up to 32 are available for active users. The extra sessions allow users to log on to as many as eight different applications or hosts, and then switch easily between them.

Termcontroller utilizes a high-performance architecture to off-load asynchronous and network functions from the host. The ITC-128 consists of seven 12 MHz Motorola 68000 processors, a VLSI IEEE 802.3 controller, and 4 MB of memory. The LTC-64 consists of three 12 MHz Motorola 68000 processors, a VLSI IEEE 802.3 controller, and 2 MB of memory.

ITC-128 Termcontroller is priced at \$9,500 for high-end MV processors. The LTC-64 Termcontroller is priced at \$5,300 for low-end L-Bus MV processors. The IAC 8-line and 24-line versions consist of a single 15-inch Data Channel board, with the option of one or two Motorola 68000 processors. The IACs house up to 1 MB of

memory, and offload many screen and interactive editing functions from the host. Pricing for an 8-line IAC ranges from \$3,400 to \$3,600. Pricing for a 24-line IAC ranges from \$7,400 to \$7,900. Δ

Data General Corporation, 3400 Computer Dr., Westboro, MA 01580; 508/898-4083.

Circle 73 on the reader service card.

DG Dasher/386 gets full ICOBOL abilities

Boulder, CO—Two products from Wild Hare Computer Systems, Inc., allow ICOBOL programs to be compiled and run on the DG Dasher/386 system running Unix.

Wild Hare's Choice! run-time system directly executes ICOBOL programs on any Unix-based Dasher system, including the new Aviion systems announced in February. Program and data files may be taken directly from DG operating systems and used under Unix.

Wild Hare's Axis Cobol is a DG-compatible ICOBOL source compiler that runs under Unix and other operating systems. It translates ICOBOL source programs into DG-compatible object code at over 7,000 lines/minute on most PCs. Δ

Wild Hare Computer Systems, Inc., P.O. Box 3581, Boulder, CO 80307; 303/442-0324.

Circle 82 on reader service card.

RDS adds to its PC integration products

Pasadena, CA—Rational Data Systems has added true file service and remote MS-DOS command execution to its line of PC integration software products. These features are included with PC/VS release 3.32 and PC/Remote release 1.30.

True file service allows direct access to AOS/VS files as though they are MS-DOS files. This feature is useful for word pro-

cessing applications where documents must be shared between users on PCs and users at terminals.

Remote MS-DOS commands allow users or batch jobs under AOS/VS to execute MS-DOS programs on PC workstations.

PC/VS is Rational Data System's LAN-based PC integration software package, which has been on the market since 1985. PC/Remote is a comparable asynch-based product that allows PCs to access an MV family server via direct or modem serial connections. Δ

Rational Data Systems, 150 South Los Robles Dr., Pasadena, California 91101; 818/568-9991.

Circle 79 on the reader service card.

Computer Engineering Associates enters hot site business

Baltimore—Computer Engineering Associates, Inc. (CEA), has opened a dedicated disaster recovery center in the Philadelphia area for Data General based computer users.

In addition to restoring a company's Data General equipment in the event of an emergency, CEA will provide technical assistance to connect nonstandard equipment to the hot site system, according to CEA president Paul R. Keys. This could include bar code scanners, OCR gear, check sorters, or specialized printers.

CEA has purchased an MV/20000 to add to its large computer base and has over 5,000 square feet of office space ready for users in the event of a disaster. Backup of the disaster recovery center is at four separate locations. Δ

Computer Engineering Associates, Inc., 3922 Vero Rd., Baltimore, MD 21227; 301/247-5244.

Circle 70 on reader service card.

Continued on page 74.

AD INDEX

Company	PG#	RS#	Company	PG#	RS#
Alloy Computer Products	20	1	NADGUG Bulletin Board	73	-
Ames Sciences, Inc.	70	2	NADGUG Conference 89	59	-
AMR	74	3	NPA Systems Inc.	77	43
Catalina Computers, Inc.	27	4	Overland Data	79	44
Chicago RIG	75	5	Rational Data Systems	31	45
Claffin & Clayton, Inc.	30	6	RAVE Computer Association, Inc.	62	46
Coastal Computer Services	76	7	Rhintek Inc.	35	47
Commercial Data Systems Corporation	57	8	Robson & Deakin Ltd.	74	48
Commercial Data Systems Corporation	37	9	Sartox Data Systems	79	49
Computer Arts, Ltd.	4	10	SAS Institute Inc.	29	-
Computer Engineering Associates, Inc.	16	11	SCIP	6	50
Computer Systems Remarketing Corp.	73	-	SCIP	43	51
Computer Systems Remarketing Corp.	73	-	Security Computer Sales, Inc.	49	52
Computer Wholesalers	39	12	Signal Computer Products Inc.	30	53
Concept Automation, Inc.	39	13	Signal Computer Products Inc.	78	54
Concept Automation, Inc.	40	14	Synergistic Software Company Ltd.	76	55
Concept Automation, Inc.	41	15	Sysgen Data Ltd.	41	56
Cybertek Software, Inc.	C2	16	:SYSMGR Bulletin Board	73	-
Data Assurance Corporation	65	17	:SYSMGR, a division of B.J. Inc.	70	57
Data Bank Associates, Inc.	70	18	:SYSMGR, a division of B.J. Inc.	78	58
Data General Continuing Products Division	C3	19	3CI	54	59
Data General Corporation	15	-	Threshold, Inc.	63	60
Data General Direct	5	20	Threshold, Inc.	75	61
Data Investors Corporation	51	21	TLC Systems, Inc.	25	62
DataLynx	45	22	Track Data	73	-
DataLynx	61	23	Transoft Ltd.	9	63
Dataram Corporation	53	24	Vantage Software, Inc.	76	64
DataSafe Corporation	10	25	Verdugo Computers, Inc.	7	65
Delphi Data	69	26	Wild Hare Computer Systems Inc.	67	66
Eagle Software, Inc.	47	27	WordPerfect Corporation	3	67
Essex Computer Service, Inc.	32	28	Zetaco	C4	68
Fast Track Systems, Inc.	11	29			
Fast Track Systems, Inc.	73	-			
Flying Point Software	13	30			
Flying Point Software	73	-			
Indiana RIG	40	31			
Indocomp Systems, Inc.	55	32			
Infodex	79	33			
International Computing Systems	19	34			
Interscience Computer Corporation	21	35			
Isaacs Consulting & Development, Inc.	73	-			
Jacobsen & Associates, Inc.	33	36			
Ki Research, Inc.	48	37			
K & M Computers	48	38			
MAXON Computer Systems Incorporated	22	39			
MAXON Computer Systems Incorporated	58	40			
McIntyre's Mini-Computer Sales Group, Inc.	56	41			
MegaTape Corporation	23	42			
Minitab Statistical Software	73	-			
NADGUG	34	-			

PRODUCTS AND SERVICES

Company	PG#	RS#
Computer Engineering Associates	71	70
Concept Automation, Inc.	76	71
Data Bank Associates, Inc.	74	72
Data General Corporation	71	73
Data General Corporation	78	74
Dataram Corporation	75	75
Delphi Data	78	76
Fast Track Systems, Inc.	78	77
Indocomp Systems, Inc.	74	78
Rational Data Systems	71	79
Rhintek, Inc.	75	80
Signal Computer Products, Inc.	76	81
Wild Hare Computer Systems, Inc.	71	82

ON-LINE HELP *Who to call for answers about NADGUG and FOCUS*

NADGUG's electronic bulletin boards

(300 or 1200 baud modem)
 Rational Data Systems **415/924-3652**
 OIS (to get an OIS ID and password, contact a DG field engineering telemarketing representative) **800/325-3065**
 In Massachusetts **800/952-4300**
 In Canada **416/823-7830**

NADGUG membership, address changes

Suzanne Himes **800/877-4787**
 (Outside the U.S.) **512/345-5316**

Information on RIGs or SIGs

Cathlene Gentry **800/877-4787**
 (Outside the U.S.) **512/345-5316**

Editorial questions, comments, article suggestions

Greg Farman or Robin Perry
 (please send product announcement to the address listed below) **512/345-5316**

Information about advertising in FOCUS

Sharon Dennis **512/345-5316**

Back issues of FOCUS

Turnkey Publishing staff **512/345-5316**

NADGUG staff

c/o Turnkey Publishing Inc.
 Stillhouse Canyon Office Park
 4807 Spicewood Springs Road
 Suite 3150
 Austin, TX 78759

FOCUS Magazine

c/o Turnkey Publishing Inc.
 Stillhouse Canyon Office Park
 4807 Spicewood Springs Road
 Suite 3150
 Austin, TX 78759

EQUIPMENT

**6239 592 MB
DG Argus
Disk Subsystem

\$10,000.**

*For information call
Barbara at
Track Data 212/943-4555*

CSR Corp.

Computer Systems
Remarketing Corp.
8601 Sanford Drive
Richmond, VA 23228
(804) 262-3555

**Wants to buy
your Data General equipment.**

Top dollar cash or trade for good used systems

CSR Corp.
The Mark Of Excellence In . . .
DATA GENERAL EQUIPMENT
CALL US FIRST AT:
(804) 262-3555

*Computer Systems
Remarketing Corp.*

*8601 Sanford Drive
Richmond, Virginia 23228*

DIAL-UP BULLETIN BOARD

**Use the
NADGUG BBS!**

*No Charge—Simple, on-line registration.
Supported by your membership dues.*

300, 1200, 2400, 9600 baud
24 hrs/day, 7 days/week

415/924-3652

Now with multiple lines and downloads!
Operated by Rational Data Systems, Inc.

EMPLOYMENT

Sales/Marketing Manager

Sell directly to distributors and VARs, establish strategic relationships and develop marketing plan for producer of terminal emulation/file transfer and utility software. Excellent compensation and benefits. Flying Point Software is a division of National Investor Data Services (NIDS), a ten-year DG VAR. Send resume to: Personnel Director, Flying Point Software, 33 Flying Point Road, Southampton, NY 11968. 516/283-1100 for information.

NADGUG MEMBER ADS — FREE

Members of NADGUG can use classified space to post personal notices. (Not too personal, please.) Rules are:

- You have to be a paid-up NADGUG member to place an ad. (Please include your name and company so we can verify membership.)
- Fifty word maximum length
- Notices must be legible. Send ads to **FOCUS** at 4807 Spicewood Springs Road, Suite 3150, Austin, Texas 78759.

SOFTWARE

**Statistical
Software**

- Powerful
- Fast
- Easy-to-use
- Inexpensive

MINITAB

STATISTICAL SOFTWARE
3081 Enterprise Dr., State College, PA 16801

814-238-3280

ICDI Programs: Fortran 5/77 AOS/VS Trees; Overlays; Cross References // Fortran 5 AOS/ AOS/VS Reformat source code // Fortran 77 Plot Interfaces for GKS supported graphics devices // Fortran 5/77 Programmer Subroutines
ICDI Rt. 6 Box 172 Smithville, Tn. 37166
(615) 597-1638 or 597-8828

:SYSMGR BBS specializes in file transfer of RDOS and AOS[VS] DUMP files - no messaging facilities. XMODEM, YMODEM, and KERMIT supported. 415/391-6531(one line), 1200 boud (Vadic 3447), 8 data bits, 1 start/stop bit or 415/550-1454 (voice). Systems is MV/4000, terminal mode is CHAR/605X.

SERVICES

**TIMESHARING SERVICES
ON MV/10000 CPU S**

- Remote Processing Thru Dial-Up Access
- 1600 & 6250 BPI Tape Drives
- Local or Remote Printing
- Complete Data Security
- Modems & Multiplexors
- 24 Hour, 7 Days a Week - Full Operator Service

FAST TRACK SYSTEMS

61 Broadway, New York, NY 10006
(212) 422-9880

CALLING ALL UK USERS

Performance Problems? Expensive Upgrade? Restricted Options?

We will guarantee performance improvement, avoiding expensive upgrades, for any DG system.

Consultancy, Computer Audit, Resource Accounting & Capacity Planning, Bureau Services and Disaster Recovery.

B32 and Business Basic spoken eloquently.

Solutions for PC Integration and Full Office Automation.

Please give us a call and ask for Phil or Tony.

Robson & Deakin Ltd.

Computer Consultants

Brierley House

Bridge Street

Pendlebury Industrial Estate

Swinton

Manchester M27 1FJ

Phone: **061-794 8080**

Telex: **668424**

Fax: **061-794 7754**

Phil Robson: 02602 76488

Tony Deakin: 0937 73446

Circle 48 on reader service card.

Virtual Terminal Emulation and File Transfer

VTerm facilitates dial-up sessions to and from any remote system, including file transfer capability. DG to DG communications using complete virtual mode. DG to PC in TTY compatible mode (great for bulletin boards, etc.).

VTerm Features Include:

- TTY Emulation
 - Supports all public networks
 - Pre-programmed script files most popular networks
- Menu-driven CEO® Style User Interface
- Xmodem File Transfer Protocol
- Supports Generation and Use of Script Files
- Context Sensitive Help
- Default Answers for Most Parameters

Price \$495.00

AMR
P.O. Box 619616 MD 4360
DFW Airport, TX 75261-9616
(817) 963-3435



CEO is a registered trademark of Data General

Circle 3 on reader service card.

Continued from page 71.

Data Bank Associates to develop ARC for DG

Germantown, MD—Data Bank Associates has signed an exclusive contract with System Enhancement Associates of Wayne, New Jersey, to develop, market, sell, and license the ARC program for Data General computers.

System Enhancement Associates will continue to upgrade and provide the ARC program in the personal computer environment. With PCs, the ARC program is used to create and maintain libraries of files that are automatically compressed and uncompressed, resulting in space savings in the files. Data Bank Associates will develop new implementations of ARC that will save disk space in the Data General environment. Δ

Data Bank Associates, Inc., 20010 Century Blvd., Suite 104, Germantown, MD 20874; 301/540-5562.

Circle 72 on the reader service card.

IS-4210 storage subsystem increases disk capacity

Drayton Plains, MI—The new IS-4210 storage subsystem from Indocomp Systems, Inc., provides Data General users with a method to increase the disk capacity of their MV/2500, MV/2000, MV/1400, and DS/7500 computers. It consists of a desktop enclosure containing a 612 MB, 5-1/4-inch Winchester disk drive, the IS-4200 controller, an interconnect cable, and an AOS/VS compatible driver.

The 612 MB disk, a Control Data Wren V, has an 18 ms average seek time and a maximum transfer rate of 1.8 MB per second. The IS-4200 is a 15-inch by 7-inch option board that plugs into any L-bus based DG computer. It contains a 68010 I/O processor and a 128 KB buffer RAM and can accommodate up to seven SCSI peripherals.

The price of the storage system is \$8,900. The price of additional 612 MB disk drives is \$5,400. Δ

Indocomp Systems, Inc., P.O. Box 157, Drayton Plains, MI 48020; 313/666-9715.

Circle 78 on reader service card.

NEW

**SKS-HP Disk Subsystems with
R.A.M.S.-like performance!**

FAST

80% *more* transactions per second per dollar, drives with 16.5 *ms* average seek time, and 2nd generation SCSI technology make SKS-HP the fastest subsystems around!

BIG

SKS-HP provides 2.6 times *more* megabytes per dollar than R.A.M.S.! Build the system you need, from 654 megabytes up to 4.2 gigabytes!

SMALL

These 5.25" drives need only 3½" vertical space in your rack, and draw only 55 watts per drive.

EASY

SKS-HP Subsystems are plug-and-go compatible with your 32-bit MV computer running under AOS/VS. Call us for a quote on price & delivery.



For the full story on how you can add a higher-than-R.A.M.S. performance at a lower price, with Data General-compatible, Argus-emulating SKS-HP Disk Subsystems, call us today!

(612) 941-9480

ZETA 

The Link To Tomorrow.

A Subsidiary of the Carlisle Corporation

6850 Shady Oak Road
Eden Prairie, Minnesota 55344
telex 290975, FAX 612-941-1395

Memory module increases capacity

Princeton, NJ—The new DR-6080 memory module from Dataram Corporation allows users of Data General MV/6000, MV/8000, and MV/8000 Model II computers to reach their maximum capacity of 16 MB.

The DR-6080's design accommodates up to 12 MB of memory on one board. When added to the CPU, the extra memory increases overall system performance to allow faster response, added applications, more users, or all three.

Dataram's DR-6080 boards are ready to use without the need to modify DG processors. The new modules carry a lifetime warranty from Dataram and are supported by the company's Express Spares Program within the United States.

There is a trade-in program for the new DR-6080 boards, with a trade-in allowance for certain DG modules. Δ

Dataram Corporation, P.O. Box 7528, Princeton, NJ 08543-7528; 1-800/822-0071 or 609/799-0071 (in New Jersey).

Circle 75 on reader service card.

EMU/470 provides color graphics emulation

Columbia, MD—Rhitek, Inc., has announced version 2 of its EMU/470 color graphics terminal emulator. EMU/470 emulates all of the top-of-the-line Data General terminals including the D411, D460, D461, and the D470C terminal. The CEO Connection, W460, provides workstation services for DG's CEO product.

EMU/470 version 2 provides graphics emulation on VGA, EGA, MCGA, CGA, and Hercules graphics adapters. A simulated compression mode, which displays 128 characters per line, is available with any of the above graphic adapters.

EMU/470 permits file transfers between a DG host and a PC. File capture and protocol transfers are included. The protocol capability includes a mechanism for calling various external protocols such as XMODEM and Kermit.

The emulator runs on IBM personal computers, IBM PS/2s, and 100 percent compatibles. It can simultaneously drive

CADGUG is alive and well and voicing it's concerns!

The Chicago Area DG User Group has been through a re-vitalizing period and is ready for an active summer! During May, in addition to a monthly meeting, CADGUG is sending out surveys to all members asking their concerns about local DG management. The June meeting will be hosted by Data General, who will address the concerns most mentioned on the surveys.

All Chicago area DG users are encouraged to fill out the surveys and turn them in so that DG can answer your questions. If you haven't received a survey to turn in, contact Don Mungovan (312/930-9400), or Jim Siegman (312/673-1700). This meeting should prove to be very interesting, don't miss it!



Circle 5 on reader service card.

SCREEN DEMON

Pop-up
Windows For
COBOL!

- Electronic Mail
- Pop-up Calculator
- Print Screen
- Pop-up Notepad
- Redraw Screen
- Swap to CLI
- Faster Screen Display

Rev. 2.0 just released!

New features include:

- View screens of programs running on other terminals
- Record and playback terminal sessions
- Automatic termination of inactive program
- Remote termination with orderly shutdown
- WP Library and CEO interfaces
- ACCEPT time-out for ICOBOL

Versions for AOS/VS COBOL and ICOBOL work with existing programs without recompilation. Screen Demon routines may be called from programs written in "C".

\$950

Demo available \$25

Threshold, Inc.

165 E. Magnolia Ave.
Auburn, AL 36831

(205) 821-0075

Circle 61 on reader service card.

any PC compatible printer or Microsoft mouse. EMU/470 is available for less than \$200 in the United States. Δ

Rhintek, Inc., P.O. Box 220, Columbia, Maryland, 21045-0220; 301/730-2575.

Circle 80 on reader service card.

Concept Automation offers CEO encryption

Sterling, VA—Concept Automation, Inc., is currently shipping version 1.2 of its CEO encrypting device, Integrated File Crypt. Encryption software is used to prevent unauthorized access to files.

The new release features two enhancements for speed and simplicity. Users now have the option of using the CEO Interrupt key during the encryption request. Also, the software can now read the status of a document.

The cost is \$7 a day for the first year on an MV/15000 model 8. Subsequent years are \$400. The AOS/VS version costs half as much. Δ

Concept Automation, Inc., 1319 Moran Rd.,

Sterling, Virginia, 22170; 703/450-6000.

Circle 71 on reader service card.

Signal offers DG/500 tape subsystems

Acton, MA—Signal Computer Products, Inc., has released new tape and disk drive subsystems for DG/500 and other DG computers.

The Pacer tape subsystem uses a standard 1/4-inch cartridge and has 150 MB storage capacity. It allows backup at a rate of 90 KB per second. In other words, an unattended backup of the standard 160 MB disk is completed in about five MB per minute. Pacer is available either as an internal mount or in a small desktop enclosure.

Sprinter is a high speed tape subsystem that can back up data at a rate of 1.5 MB per second using VHS technology. The 8 mm cartridge can store 2.3 gigabytes.

Both units come with controller, cables, and mounting instructions.

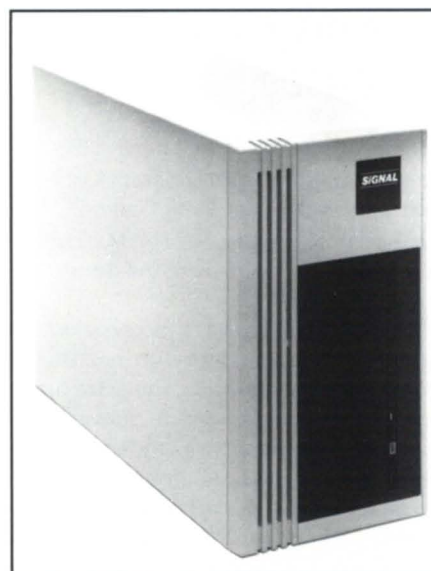

The Vault

For disk drives, Signal has released the Vault/380 and the Vault/780, which offer 380 MB and 780 MB of storage respectively, and access time of 16 ms. Data transfer rate can reach as high as 4 MB

CALLING ALL UK USERS

There are many third party products that can improve the efficiency of your Data General computer environment. Some of the most popular ones are indicated below:

B32 now has both CEO and Library shell interfaces.

Dimension is a 4GL which creates robust, commercial environment BB code.

EMU/470 is the most cost-effective way to color your applications.

File Finder is a utility for information retrieval with AOS/VS files.

GENISYS I is a fully featured DBMS for non-technical end users.

InfoLynx takes the strain from INFOS users.

PC/Remote gives PC integration using async RS232 instead of LANs.

THE ULTIMATE could save a lot of coding for INFOS users.

WPFile provides drawers, folders and documents for WordPerfect users.

WordPerfect is simply the best word-processing software for DG.

20/20 is the definitive spreadsheet product, now with CEO integration.

If you think that there may be other third party packages that would be of benefit to you, please phone, we would be delighted to help you to prove the case.

Synergistic

Hughenden House
Main Street
Collingham
West Yorkshire
LS22 5AY

Software

Company Ltd.

Phone 0937 74637
(24 hr) 0937 73446
Fax 0937 66903

All products listed above are trademarks of their respective companies.

Circle 55 on reader service card.

WE BUY-SELL & TRADE

CPU 's/MEMORIES /SOFTWARE :

MV 20000/15000

MV 2000/4000/8000/10000

Desktop Model's 10/20/30

NOVA & Eclipse CPU's & Memories

DISKS/TAPES:

6239 592MB Disk Subsystem

6236 354MB Disk Subsystem

6161 147MB Disk Subsystem

6122 277MB Disk Subsystem

6061 192MB Disk Subsystem

6060 96MB Disk Subsystem

6161 147MB Disk Subsystem

6160 73MB Disk Subsystem

6125 1600BPI Tape Subsystem

6026 1600/800BPI Tape Subsystem

6021 800BPI Tape Subsystem

PRINTERS:

DP300 300 LPM Subsystem

4215 600 LPM Subsystem

4034G 300 LPM Subsystem

PR1250 Rolland Printers

CRT'S:

6500 D216

6168 D210

6246 D-460

6391 D-214

6169 D211

WY60 WYSE

COMMUNICATIONS:

4368 IAC-16

4367 IAC-8

4257 ALM-16

4255 ALM-8

4241 ULM-5

4340 AMI-8

Call for prices on Equipment not Listed

All Equipment Guaranteed
For Data General Maintenance.

**COASTAL COMPUTER
SERVICES INC.
(206)734-3928**

Circle 7 on reader service card.

AOS/VS Consulting

System Tuning

Networking/Communications

DG/DBMS PRESENT

INFOS CEO

TRENDVIEW C/SCRIPT II

UNIX RM/COBOL

Commercial Applications

Development Installation

Support

Tool Packages

MENUMANager

BACKUPMANager

SPOOLMANager

Conversions

ICOBOL→AOS COBOL

COBOL→RM COBOL

Turnkey Applications

A/P, A/R, P/R, GL, OE, INV, PO

Mes AMIS Apparel Manufacturers'

Information System

Upgrades

Authorized Data General

System Supplier

VANTAGE SOFTWARE, INC.

(212) 956-2240

555 W. 57th Street, 11th Floor
New York, NY 10019

Circle 64 on reader service card.



LEADING THE WAY

In the 5th Generation of Service . . .



3 times bigger to serve you 10 times better.
Your total support is here . . . NOW!!!

Serving all your Data General needs



SERVICE DIVISION:
 24-Hours, 7 Day Coverage
 10,000 Sq. Ft. Repair Shop
 Full Systems Testing Facility
 Upgrade Emulation Service
 Full Support For "Mixed Systems"
 "Swap & Repair" Program
 Free Upgrade Installation
 Expanded Service Locations
 Largest On-Hand Spares

HARDWARE DIVISION:
 10,000 Sq. Ft. Warehouse
 New and Reconditioned Systems
 Leases, Rentals and Trade-Ins
 Power Conversions For Exports
 Spare Parts
 Peripherals
 Compatibles
 Over Night Deliveries



**FACILITY MANAGEMENT/
 RECOVERY SITE:**
 10,000 Sq. Ft. Computer and
 Conference Space
 Office Space
 State-Of-The-Art Computer Room
 Software Testing Facility
 On-Line MV 20,000's, 320 Users
 Full Site Generator Back-up
 400 Line Communication Center
 Free Recovery Site For
 Qualified Customers
 Multiple Facilities In The USA

SOFTWARE DIVISION:
 Operating System Support
 Application Software
 Turn-Key Systems
 Office Automation
 Custom Program Design
 4th Generation Language

EAST COAST MAIN OFFICE:

NPA Systems, Inc.
 761 Coates Avenue, Holbrook, New York 11741
 (516) 467-2500 • FAX: 516-467-5609

WEST COAST MAIN OFFICE:

NPA Systems of California, Inc.
 2323 Fourth Street, Berkeley, CA 94710
 (415) 848-9835 • FAX: 415-845-1665

Finally... An AOS/VS Performance Seminar for Normal Humans.

Brian Johnson is leading three-day seminars covering the basic principles of AOS/VS performance analysis & capacity planning. The minimum prerequisites are 6 months of experience as an AOS/VS System Manager or System Programmer, and access to a performance analysis utility such as **PERFMGR** or DG's **MONITOR**.

Schedule:

July 10-12	New York
Oct 16-18	San Francisco
Feb 12-14	San Francisco

Call for a registration kit, or for on-site seminar information.

:SYSMGR

Software for System Managers
A Division of B.J. Inc.

109 Minna Street, Suite 215
San Francisco, CA 94105 (415) 550-1454

Circle 58 on reader service card.

SIGNAL
SIGNAL
SIGNAL
SIGNAL

Datasouth
Datasouth
Datasouth
Datasouth

High Reliability Printers For DG Users

SIGNAL COMPUTER
PRODUCTS Inc.

Acton, Massachusetts 01720

508/263-6125

Your Authorized Distributor

Circle 54 on reader service card.

PRODUCTS AND SERVICES

per second, according to Signal. Both models are fully compatible with DG software.



The Sprinter

The Vault series subsystems are available in a small desktop enclosure or standard rackmount enclosure. They come with drives, controllers, cables, and installation instructions. Δ

Signal Computer Products, Inc., 411 Massachusetts Ave., Acton, MA 01720; 508/263-6125.

Circle 81 on reader service card.

Fast Track acquires Sysgen contracts

New York—Fast Track Systems, Inc., signed an agreement with Sysgen Recovery Services, Inc., to acquire Sysgen's contracts for DG hot site services. Sysgen will no longer maintain a disaster recovery business, but will act as an agent for Fast Track, focusing on new business development. Both organizations are leading providers of hot site services to users of Data General equipment.

Fast Track Systems, Inc., operates hot site locations in Chicago, Brooklyn, and Wall Street. Services include alternate computing facilities, on-site equipment inventory, private communications networks (available in most cities), and consulting.

Data General has qualified Fast Track Systems, Inc., as a provider of DG hot site services, based on Fast Track having met criteria established by Data General. In addition to DG hot site services, Fast Track provides off-site data storage, facilities management, and contingency consulting. Communications hubs are located in San Francisco, Los Angeles, Dallas, Philadelphia, Miami, Chicago, and Toronto. Δ *Fast Track Systems, Inc., 61 Broadway, New York, NY 10006; 212/422-9880.*

Circle 77 on reader service card.

High availability uninterruptible power supplies new from DG

Westboro—Data General Corporation announced a line of high availability uninterruptible power supplies (UPS). The UPS systems are field upgradeable, on-line peripherals designed to clean the electrical power to the computer system, and to provide power when normal utility power is lost during a brownout or blackout. The UPS systems further enhance the systems availability of the high-end Eclipse MV/40000 and MV/40000 HA computer systems.

The high availability uninterruptible power supplies are available in power ratings from 50 KVA to 125 KVA. This now expands Data General's online UPS product line from 3 KVA to 125 KVA. United States list prices for the power supplies start at \$55,000 for the 50 KVA unit and \$74,000 for the 125 KVA unit. Δ *Data General, 4400 Computer Dr., Westboro, MA 01580; 1-800/343-8842.*

Circle 74 on reader service card.

Delphi Data announces generic SCSI disk cache controller

Riverside, CA—Data General's MV series of computers can use the newest high performance SCSI disk drives with Delphi Data's Cache Box family of RAM cache controllers. The Cache Box connects a host CPU and one or more SCSI disk drives.

The MV/1400, MV/2000 (new style), and MV/2500 have built-in SCSI controllers that can control many SCSI drives, any of which may be connected to a Cache Box. The MV/4000 through MV/40000 use SCSI disks by the addition of the single slot CSS controller made by DG.

The Cache Box functions with DG-RDOS, AOS/VS, AOS/VS II, and DG/UX, binary compatible MV machines, and the new 88000 machines. Δ *Delphi Data, 12155 Magnolia, Suite 6C, Riverside, CA 92503; 714/354-2020.*

Circle 76 on reader service card.

The Value Added Resellers whose products are advertised on these pages are all Data General VARs and have been recognized in the marketplace as leaders. This section of Focus provides a sampling of the products that are available through DG VARs. If your company is a DG VAR that would like to be included, or if you know of other DG VARs that may be interested, please contact the Focus Associate Publisher at 512/345-5316.

Grow With the Best!



From...
FINANCIAL to DISTRIBUTION to MANUFACTURING,

ALCOR® Information Systems offer an integrated, comprehensive package designed by professionals for today's aggressive marketplace. We at **SARTOX™** can meet your needs.

SARTOX™ DATA SYSTEMS



THE INFORMATION CRAFTSMEN

P.O. Box 35623, Richmond, Virginia 23235-0623
(804) 794-2800 FAX (804) 794-7649

Circle 49 on reader service card.

DG VAR?

You could be here! Put your company in front of the most active Data General users available -- call and place your VAR ad today!

512/345-5316

**INFODEX PRESENTS
CONVERSION PLUS™**

Moving from one Data General to another or between different vendors has become far easier with **CONVERSION PLUS™**. Now, transfer between data media and upgrade your software—all through Infodex, the Data General experts.



**Call Now
(201)
662-7020**

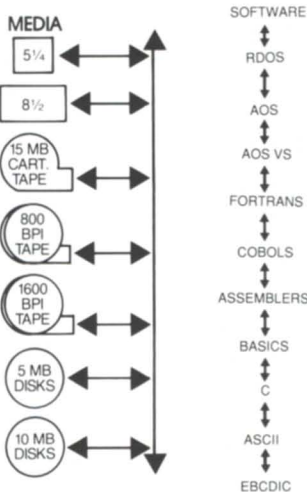

INFODEX

7000 Boulevard East • Guttenberg, NJ 07093

Circle 33 on reader service card.

**9-Track Tape Drives: Yes!
for IBM PC/XT/AT/386
and PS/2**



Read or write 9-track tapes from mainframes and minis to your personal computer – including the **PS/2 Micro Channel**. Our TapeLinx 9-track tape subsystems offer these important features:

- 800, 1600, 3200, 6250 BPI
- IBM & ANSI labeled tapes
- Quality customer service
- High speed controller
- Network backup
- EBCDIC/ASCII
- DOS, XENIX, UNIX
- DOS device driver

For quick delivery we stock all major manufacturers' tape drives including Cipher, Kennedy, M4 Data, Qualstar. Prices start at \$3,755. Call Today!



Overland Data Inc.

5620 Kearny Mesa Rd. • San Diego, CA 92111
Tel: (619) 571-5555 ext. 64 • FAX: (619) 571-0982

TapeLinx is a registered trademark of Overland Data, Inc.
IBM PC, XT, AT, PS/2 (Personal System/2) and Micro Channel are registered trademarks of IBM Corp.
XENIX and MS-DOS are registered trademarks of Microsoft Corp.

Circle 44 on reader service card.

Data General will port **Novell's** new Open Netware LAN services to the Eclipse MV/family of computers and to the company's new Aviiion family of Motorola 88000 Unix-based systems unveiled at the end of February in San Francisco.

The DG marketing and development agreement with Novell is in conjunction with Novell's introduction of a portable version of its Netware product, which currently holds the largest market share in the international PC LAN market.

"This agreement is part of our new Distributed Applications Architecture and represents the second phase of Data General's open LAN strategy—aimed at giving existing and future customers the freedom to choose a network architecture based upon individual computing needs," said **John Kavazanjian**, Data General vice president of network services, Communications Systems Group.

Data General is the first major minicomputer vendor to embrace **IBM's** strategic communications programming interface, known as the **Common Programming Interface—Communications (CPI-C)**. CPI-C enables applications running on Data General and IBM systems in a systems application architecture (SAA) environment to communicate while making the network transparent to those applications.

"This commitment to CPI-C illustrates our grasp on what it takes to be the leader in adhering to IBM communications standards," said **Joe Clabby**, **Communications Sector** marketing manager at Data General. "We are committed to providing our own customers with products that can capitalize on IBM's series of SAA standards. Our adherence to CPI-C will help ensure a common communication environment for application interaction where program-to-program communication based on CPI-C is appropriate."

Data General also announced in March two new communications software products and enhancements to seven others that expand the interoperability of Data General and IBM systems.

Teledyne Control Applications, a division of **Teledyne, Inc.**, of Los Angeles,

and Data General are combining forces to market and sell the first minicomputer-based Unix supervisory control and data acquisition (SCADA) system.

Vector, Teledyne Control Application's market-leading SCADA system, will be ported to DG/UX software. The system will run on MV/family computers and Aviiion RISC workstations and servers.

Ed Holmes, marketing director for Teledyne Control Applications, said his company had been searching for a Unix operating system for SCADA. "We looked at different minicomputer vendors; when we compared the design, implementation, and performance of DG/UX, we decided that its features and flexibility are the most advanced in the industry. We feel that Data General will establish itself as a leading Unix systems vendor," he said.

Both Teledyne and DG have been successful in the SCADA industry, having co-developed systems with **Exxon** and for the Alaskan pipeline, among others.

Teledyne also became a DG cooperative marketing value-added reseller (CMV).

The following from :SYSMGR speaks for itself:

":SYSMGR is sponsoring a contest to award the **First Annual UPDATE.CLI Trophy**. The trophy will be awarded to the individual or group that submits the program that most outrageously exhibits how CPU time can be senselessly squandered doing even the most trivial task. Entries that most closely reflect the contest theme, '**MIPS, the Breakfast of Champions**,' will be given special consideration.

"The award was created in order to memorialize the AOS/VS UPDATE tool. The UPDATE tool was developed by Data General in order to make the installation of AOS/VS updates more user-friendly and bullet-proof. Clearly, CPU consumption was not a consideration; the program takes an hour and 20 minutes of CPU time on an MV/4000 to install AOS/VS 7.60 Update 04.

"All entries should be submitted in source listing form and must indicate CPU type and estimated CPU time, if possible. Estimated CPU time must be finite. All entries will become property of :SYSMGR, so please don't send listings of produc-

tion software from your own systems, as suitable as they might be. Entries may be submitted in person at the :SYSMGR booth at **NADGUG's** Conference '89, or by mail to the address below.

"The deadline for submitting entries is noon, Wednesday, September 20. Presentation of the award will be made at **NADGUG's** Conference '89 during a special press conference to be held in the bar area of the conference hotel on Wednesday night."

For details, contact **Carla Perumean**, marketing director, :SYSMGR, 109 Minna St., Suite 215, San Francisco, CA 94105; 415/550-1454.

Richard Finmore reports that the annual general meeting of the **Data General User Group of the United Kingdom and Northern Ireland**, held March 9-10 in London, was an even bigger success than last year's event. His gauge for success was the fact that many of the attendees were still in the hotel bar talking things over three hours after the conference concluded. Presentations by **Tim Reiter** of Data General and **Brian Johnson** of **B.J. Inc.** were especially well-received, according to Finmore.

In other DGUG business, **Hugh Ross** was elected to another term as chairman, and **Mike Hunt** became deputy chairman. Finmore will serve as a salaried managing director (the DGUG is organized as a limited corporation). **Graham Woodage** was appointed to serve as a liaison to Data General.

The DGUG is planning its next annual general meeting for late March next year; it continues to extend an invitation for **NADGUG** members to attend.

Don Mungovan, president of the **Chicago Area Data General Users Group (CADGUG)**, was unable to attend **NADGUG's** Spring Board Meeting because he was in London attending the UK DGUG conference. Coincidentally, the UK conference was held at the same time as the **NADGUG** board meeting in New Orleans (March 9-10). Mungovan won the free trip to London at the 1988 **NADGUG** conference.

DIRECT FROM OUR FACTORY TO YOUR BUSINESS.



MEETING CUSTOMERS' NEEDS AND EXPECTATIONS.

At Data General we uphold the tradition of providing more powerful and cost efficient computers. And our customers have come to expect advancements from us in other areas including operating systems and utilities, data management systems, development tools, communications, office automation systems and applications.

WE BELIEVE IN BEING DIRECT.

It stands to reason, since we are the original equipment manufacturer, that we are the experts when it comes to refurbishing our Data General equipment. Our quality refurbished products—from CPUs to peripherals—are installed by both large and small customers. We offer you more benefits with each refurbished sale than any other source in the marketplace.

WE'LL DIRECT YOU TO THE RIGHT EQUIPMENT FOR YOUR NEEDS.

With the help of a Data General sales representative or your Value-Added Reseller (VAR), you may choose from our large product selection ranging from laptop portables up to the large ECLIPSE computers as well as packaged systems, magnetic peripherals, terminals, and communications and terminal interfaces.

DIRECTLY SPEAKING, WE TAKE "REFURBISHING" AS A SERIOUS BUSINESS.

You can feel assured that there are no risk factors involved when you purchase our refurbished products. Take advantage of these benefits...

- We offer low, competitive prices!
- Our products are refurbished with the latest ECOs relative to software enhancements!
- The warranty is identical to the warranty for our new products!
- We guarantee that each refurbished product has Data General field service certification before it is shipped to you!
- Data General field engineering and maintenance services are available!
- We offer Data General leasing options!

DIRECT FROM OUR FACTORY TO YOUR BUSINESS.

We have a dedicated marketing staff in our Continuing Products Division (CPD) ready to assist your DGC sales representative or VAR with configuration and pricing information.

Whether you are looking for a packaged system or a stand alone one, CPD marketing will locate the product or, depending upon your company's DP needs, may suggest a better product alternative. So if you are as serious about quality refurbished equipment as we are, then call your local Data General sales office or VAR immediately. They will work with CPD marketing to bring you the best solution... **direct from our factory to your business!**

TELEPHONE YOUR DATA GENERAL SALES REPRESENTATIVE OR VAR TODAY!

Or write for our free reference catalog on refurbished equipment. Data General Corporation, ATTENTION: Advertising Manager, 2400 Computer Drive. M.S. 1-D, Westboro, MA 01580.

Data General

Continuing Products Division
(508) 870-1400

© copyright Data General Corporation. 1988.