

THIS DRAWING AND SPECIFICATIONS HEREIN ARE THE PROPERTY OF DATA GENERAL CORPORATION AND SHALL NOT BE REPRODUCED OR COPIED OR USED IN WHOLE OR IN PART AS THE BASIS FOR MANUFACTURE OR SALE OF ITEMS WITHOUT WRITTEN PERMISSION.

REVISIONS				
REV.	DESCRIPTION	DRFTG.	APP. BY	DATE
01	ECO 393	RNK		7-77
02	ECO 585	WJG		11/77
03	REV PER ECO 713	JES		1/78

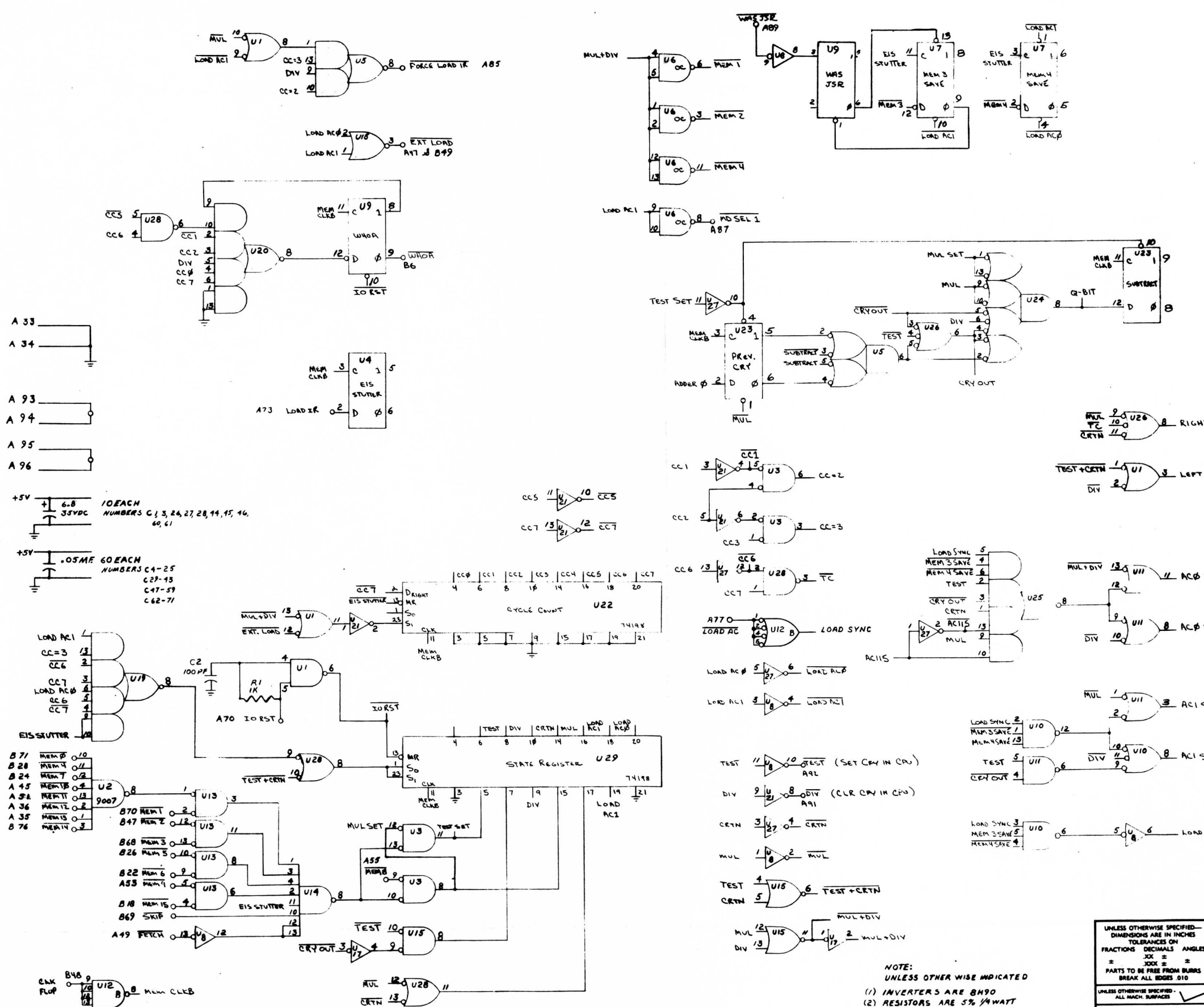

**DIVIDE NOTES:**

**TEST:** AC0-AC2  
 IF NO CARRY OUT OF ADDRESS, SHIFT RIGHT  
 LEFT  
 IF CARRY OUT OF ADDRESS, TERMINATE DIVIDE.

**DIV:** ALWAYS ADD DURING FIRST CYCLE  
 AFTER TEST.  
 IF LAST QUOTIENT BIT = 0, THEN:  
 AC0+AC2 → AC0  
 AC0+AC1 SHIFTED LEFT, Q-BIT → AC15  
 IF LAST QUOTIENT BIT = 1, THEN:  
 AC0-AC2 → AC0  
 AC0+AC1 SHIFTED LEFT, Q-BIT → AC15  
 QUOTIENT BIT = CRY OUT @ SUBTRACT  
 @ PREV CRY  
 DURING LAST CYCLE (TC), DON'T  
 SHIFT AC0.

**CRTN:** IF FINAL QUOTIENT BIT = 1, THEN:  
 DO NOTHING, YOU'RE FINISHED  
 IF FINAL QUOTIENT BIT = 0, THEN:  
 AC0+AC2 → AC0  
 DON'T SHIFT AC0 OR AC1

NOTE:  
 UNLESS OTHERWISE INDICATED  
 (1) INVERTERS ARE 8H90  
 (2) RESISTORS ARE 5% 1/4 WATT

QTY.	DESCRIPTION	PART NO.
	DRAWN	
	CHECKED	
	ENGINEER	
	APPROVED	
	FIRST USED ON	107-000100
	MATERIAL	
	FINISH	
	SCALE	

<b>DATA GENERAL CORPORATION</b> SOUTHBORO, MASSACHUSETTS 01772			
TITLE			
<b>MUL/DIV</b> <b>NOVA 1200</b>			
SIZE	CODE	DRAWING NUMBER	REV.
D	001	000131	03

D

C

B

A

D

C

B

A

8

7

6

5

4

3

2

1

8

7

6

5

4

3

2

1

THIS DRAWING AND SPECIFICATIONS HEREIN, ARE THE PROPERTY OF DATA GENERAL CORPORATION AND SHALL NOT BE REPRODUCED OR COPIED OR USED IN WHOLE OR IN PART AS THE BASIS FOR MANUFACTURE OR SALE OF ITEMS WITHOUT WRITTEN PERMISSION.

REVISIONS				
REV.	DESCRIPTION	DRAFT.	APP. BY	DATE
03	PER SHEET 1	RMB		4/15/71

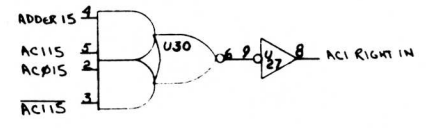
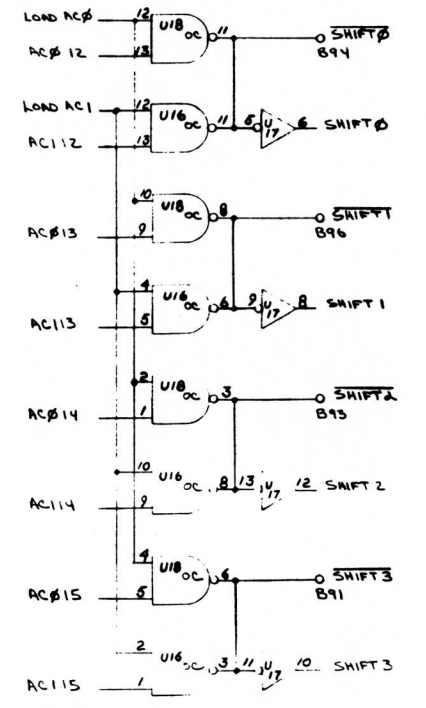
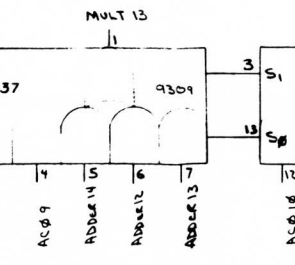
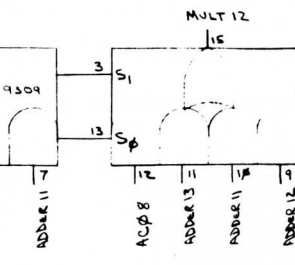
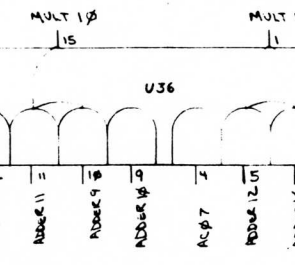
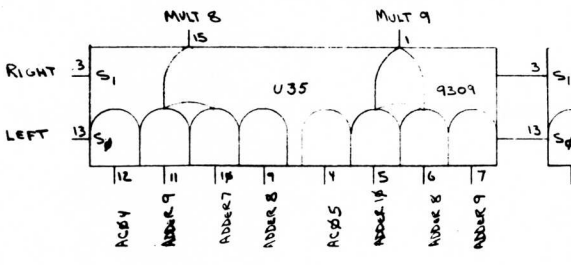
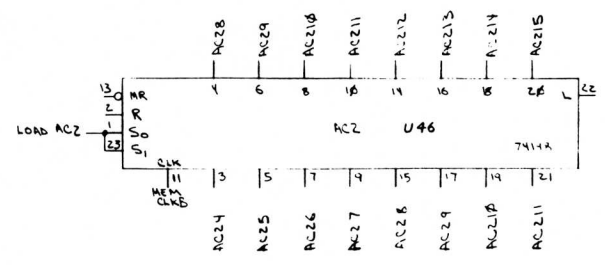
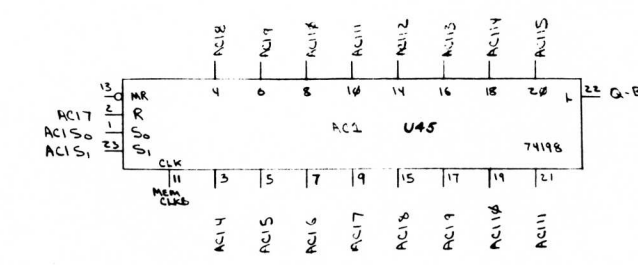
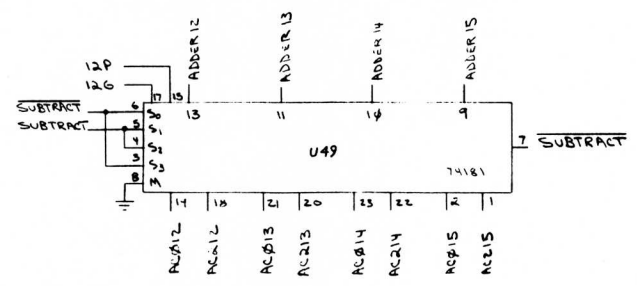
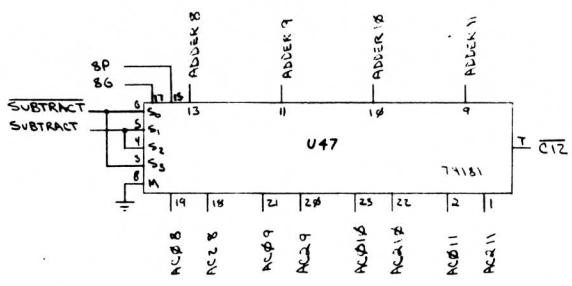
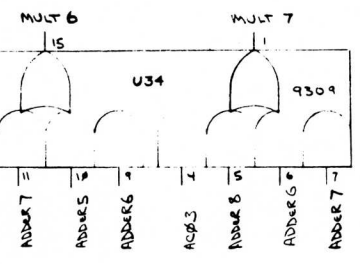
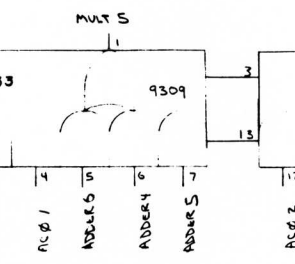
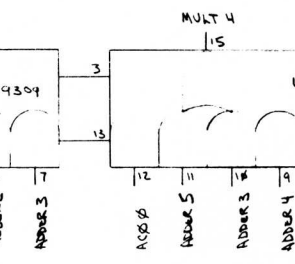
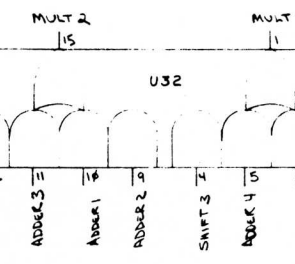
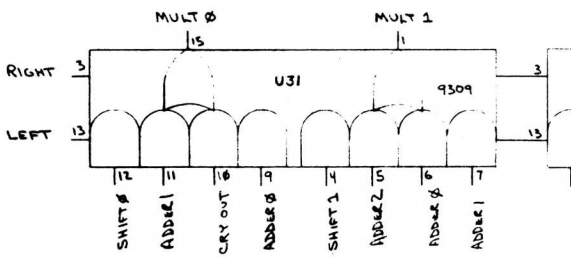
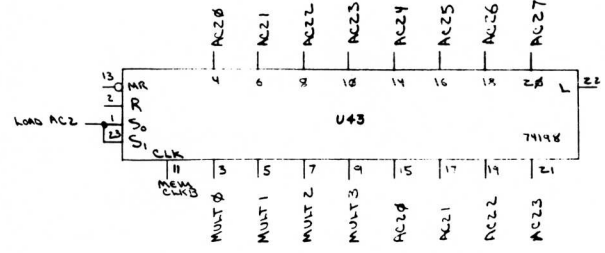
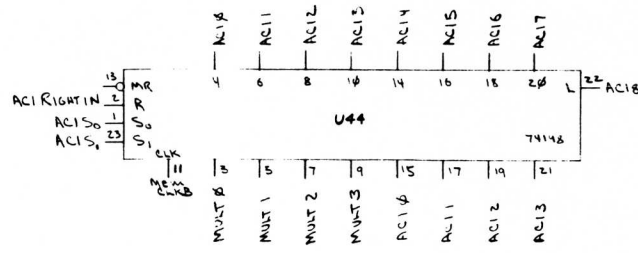
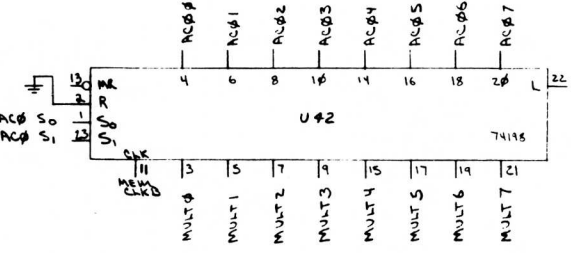
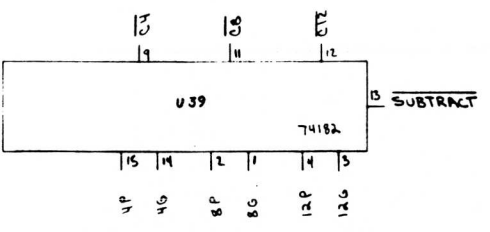
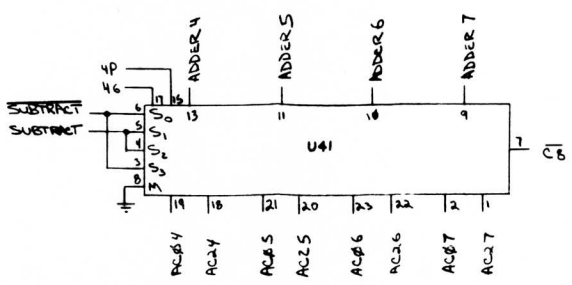
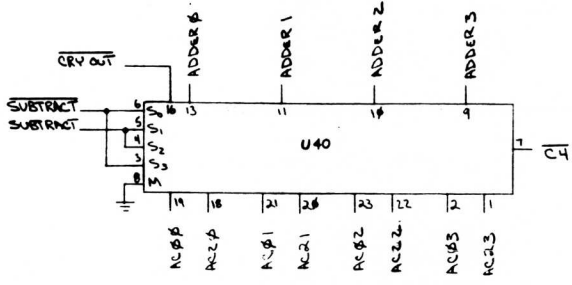

QTY.	DESCRIPTION	PART NO.
	<b>DATA GENERAL CORPORATION</b> SOUTHBORO, MASSACHUSETTS 01772	
	TITLE <b>MUL/DIV</b>	
	FIRST USED ON 107-000 100	
	SCALE	
SIZE D	CODE 001	DRAWING NUMBER 000131
		REV. 03